

Plumbing

est. 1947

DUFF^{co.}

When you need it now... or don't know how

PLUMBING & HEATING • PUMPS • WATER CONDITIONING
MULTIFAMILY HOUSING SUPPLIES

CATALOG

610.275.4453

duffcompany.com





RELIABILITY BUILT IN™



000888-45
PRE-RINSE SPRING
• Fits all competitors



B-0044-H
STAINLESS STEEL HOSE with HANDLE
Handle:
• Interchangeable with Chicago, CHG, Zurn and Krowne
• Requires 172A adapter to fit Fisher PRU



B-0113-B
PRE-RINSE UNITS

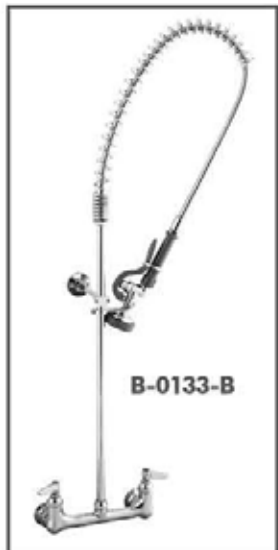

B-0133-B

SPRAY VALVES

B-0107 (1.42 GPM)

B-10K
B-0107 SPRAY VALVE PARTS KIT
• Fits on Fisher, Chicago, CHG, Zurn and Krowne hoses

B-0107-J (1.07 GPM)

CARTRIDGES

PRE-RINSE UNITS

Hot Side

Cold Side
• Fits CHG and Krowne

012446-25 Ceramic Cartridge with Spring Check, Lever Handle, Index and Screw, Hot
012447-25 Ceramic Cartridge with Spring Check, Lever Handle, Index and Screw, Cold

NOZZLES



059X

062X



ADD-ON FAUCET
B-0155-LN
• Interchangeable with Fisher, Chicago, CHG, Zurn and Krowne



BASE FAUCETS



B-0230-LN

B-0230-K

- Fits all competitor models with 1/2" FE inlets



Kit Contains (2) of each item

FAUCET INSTALLATION KIT (B-0230-LN)



B-1110-LN



B-1115-LN



B-1120-LN

NOZZLES



059X

062X

133X

FAUCET CARTRIDGES



Cold Side

Hot Side

- Fits CHG and Krowne

FAUCETS

002712-40 Eterna Cartridge with Integral Spring, Lever Handle, Index and Screw, Cold

002711-40 Eterna Cartridge with Integral Spring, Lever Handle, Index and Screw, Hot



Cold Side



Hot Side

B-1100 DECK-MOUNT FAUCETS

002710-40 B-1100 Spindle assembly with Lever Handle, Index and Screw, Hot

002709-40 B-1100 Spindle assembly with Lever Handle, Index and Screw, Cold

TWIST HANDLE WASTE VALVE

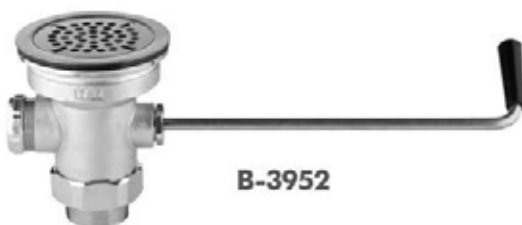

B-3952

SAFE-T-LINK GAS HOSE and INSTALLATION KIT



HG-4D-48K



PRODUCT ADAPTABILITY

T&S Brass offers unparalleled product adaptability. Our extensive product lines include base faucets, nozzles, aerators, goosenecks, spouts, handles and inlet options, and many combinations of T&S components are available.

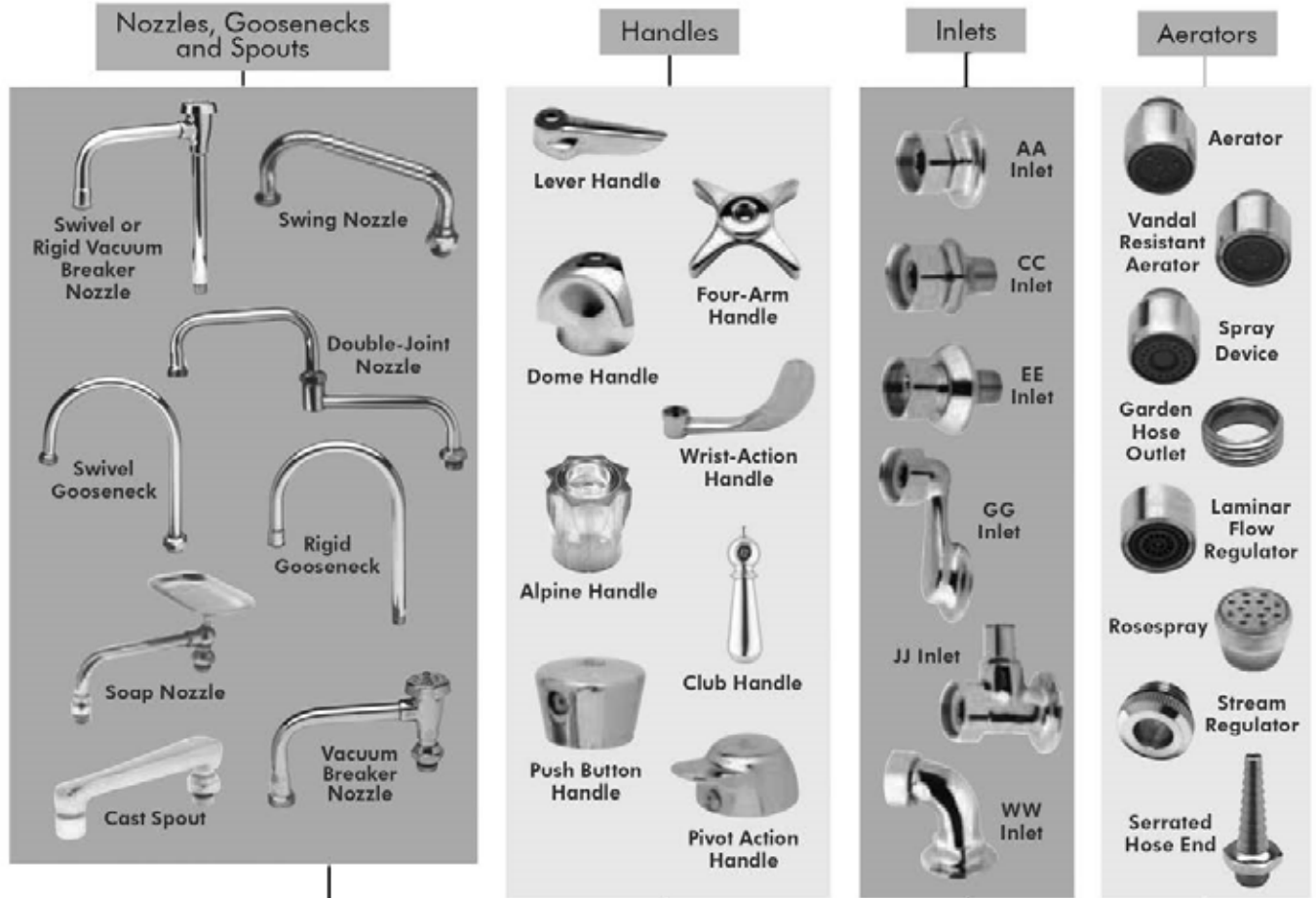

T&S Swivel or Rigid Faucets Can Combine with a Wide Variety of T&S Goosenecks, Nozzles, Spouts, Handles, Inlets and Aerators



For example to customize your faucet, you could specify:





The Superior Features of a
T&S **EasyInstall** Pre-Rinse Unit

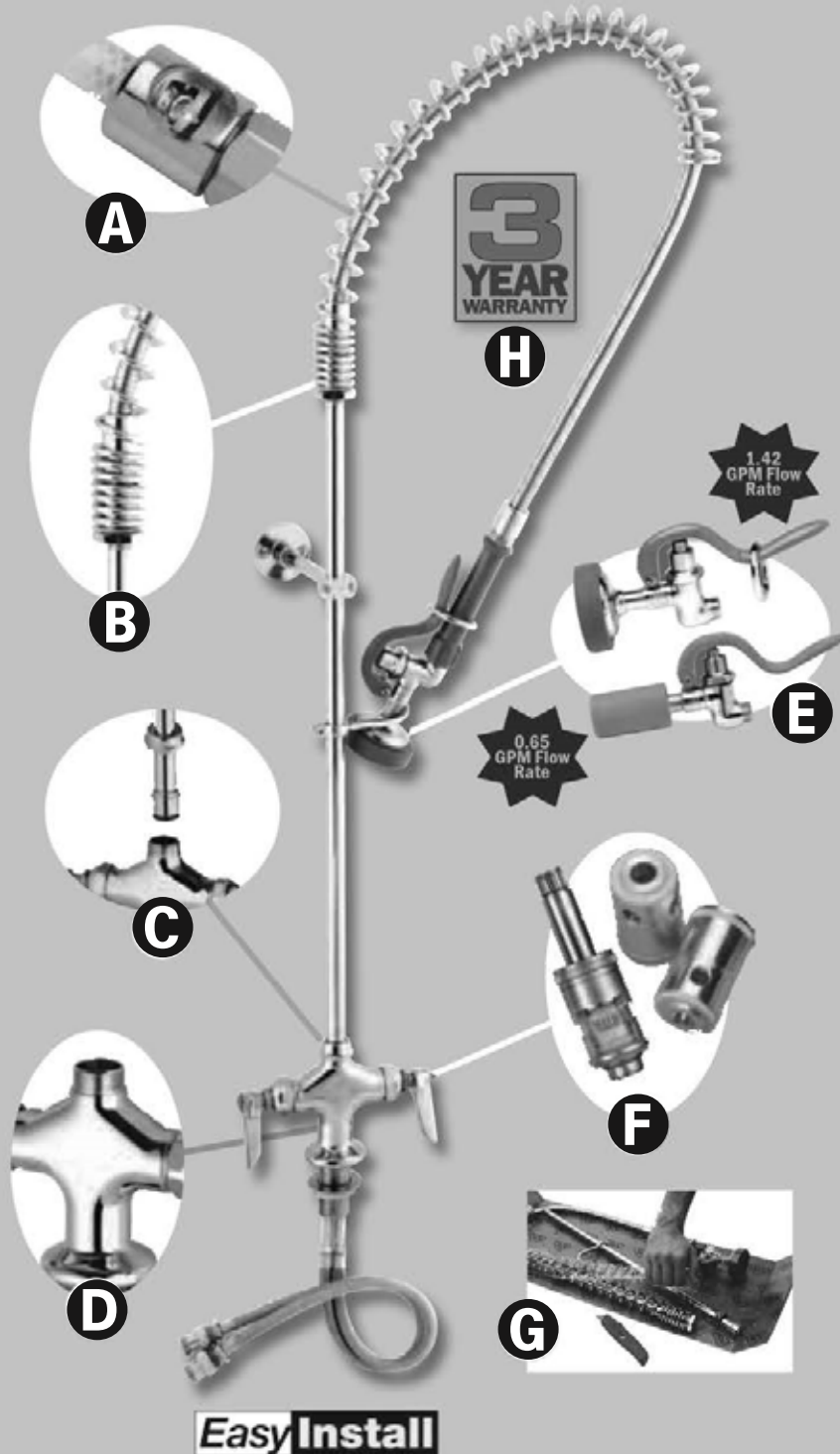

A HOSES

- Stainless steel hoses with double interlocked covers for long life
- Sealed ends prevent tears
- Vinyl nylon reinforced inner hose tested to 1200 PSI

B SPRING

- Specially designed spring reinforced at the stress point where hose connects
- Protects and extends life of hose

C EASYINSTALL

- Patented design
- Unique “pop-and-lock” riser connection that takes as little as 10 minutes to install

D FAUCETS

- Forged one-piece base faucet eliminates leaks
- Copper layer over casting makes smoother surface
- Thick chrome plating

E SPRAY VALVES

- Significant water savings with low-flow rates
- Uncompromising performance
- Tested to over 1.5 million cycles

F CARTRIDGES

- Interchangeable
- Self-contained and easily replaced
- Ceramic or compression

G PACKAGING

- Pre-assembled parts are ready for quick installation
- Fewer parts to misplace

H WARRANTY

- Long 3-year warranty on your T&S EasyInstall PRU

EasyInstall

Introducing ...

T&S Brass EasyInstall Low Profile Pre-Rinse Line



The T&S Pre-Rinse Solution For Limited Kitchen Space

In 1947, we introduced the market's first pre-rinse unit to the foodservice industry. Today, T&S pre-rinse units remain the industry standard.

Leading the way in innovation, we are pleased to introduce our new line of T&S Low Profile Pre-Rinse Units, designed to fit in compact kitchens and in tight spaces.

All T&S Low Profile Pre-Rinse Units include many of the same high-quality components and features you already find with our standard-sized pre-rinses:

- **EasyInstall design** saves significant installation time
- **B-0109-01 6" Wall Bracket** for added stability
- **Add-On Faucet with Swing Nozzle** for pot and kettle filling convenience
- **EPAAct2005 Compliant water-conserving Spray Valves**



Low Profile Pre-Rinse Unit Configurator – Build Your Own Low Profile Pre-Rinse!

- **Wall or deck mount Base Faucet** with your choice of **Ceramic or Compression Cartridges**
- **Compact Spring with Flexible Stainless Steel Hose and Finger Hook**



Customizing Made Easy

Options available for each T&S Low Profile Pre-Rinse Unit allow you to order exactly what you need.

Examples of Available Models

MPY-2DCN-06 – Single deck mount base faucet, add-on faucet, 6" swing nozzle, compact spring and hose, B-0107-C spray valve, 6" wall bracket, club handles

MPZ-2DCN-06 – Single deck mount base faucet, add-on faucet, 6" swing nozzle, compact spring and hose, B-0107 spray valve, 6" wall bracket, club handles

MPZ-2DLN-06 – Single deck mount base faucet, add-on faucet, 6" swing nozzle, compact spring and hose, B-0107 spray valve, 6" wall bracket, lever handles

MPZ-8WCN-06 – 8" Wall mount mixing faucet, add-on faucet, 6" swing nozzle, compact spring and hose, B-0107 spray valve, 6" wall bracket, club handles

MPZ-8WLN-06 – 8" Wall mount mixing faucet, add-on faucet, 6" swing nozzle, compact spring and hose, B-0107 spray valve, 6" wall bracket, lever handles



NEW KITS!

MPZ-KIT-LN06 Retrofit kit with B-0107, Eterna cartridges, add-on faucet with 6" swing nozzle and lever handles

MPZ-KIT-LN06-CR Retrofit kit with B-0107, Cerama cartridges, add-on faucet with 6" swing nozzle and lever handles

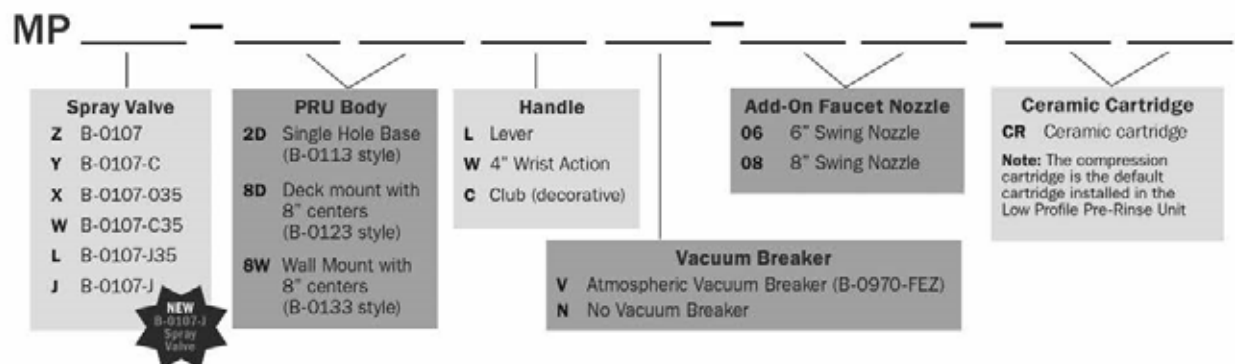

T&S BRASS FAUCETS AND FITTINGS

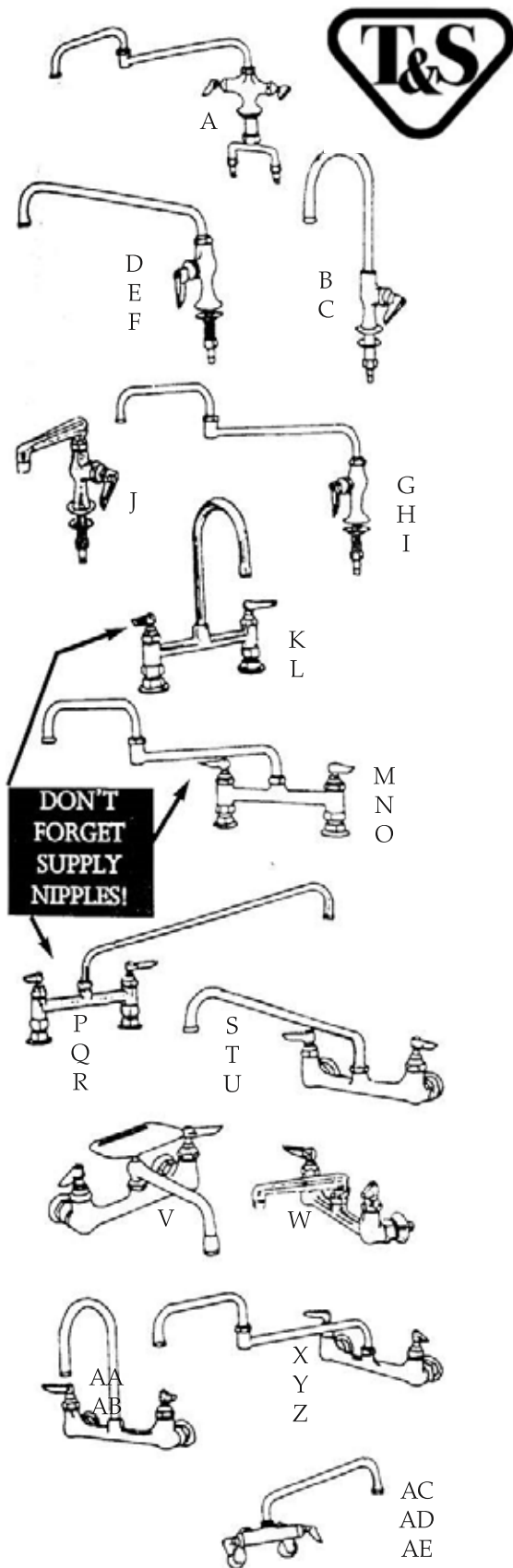

	FIG. NO.	DESCRIPTION
A	29124	Double pantry faucet with 12" double joint swing nozzle
B	51891	Single pantry faucet with 13 1/4" high rigid gooseneck spout
C	51842	Single pantry faucet with 12 1/4" high swivel gooseneck spout
D	51843	Single pantry faucet with 18" swing nozzle
E	51844	Single pantry faucet with 12" swing nozzle
F	51845	Single pantry faucet with 6" swing nozzle
G	29125	Single pantry faucet with 18" double joint swing nozzle
H	29126	single pantry faucet with 15" double joint swing nozzle
I	29127	Single pantry faucet with 12" double joint swing nozzle
J	28922	Single pantry faucet with 6" cast nozzle
K	51846	Deck-mount faucet with 12 3/4" high rigid gooseneck spout
L	15627	Deck-mount faucet with 12 3/4" high swivel gooseneck spout
M	51847	Deck mixing faucet with 18" double-joint swing nozzle
N	29120	Deck mixing faucet with 15" double joint swing nozzle
O	29121	Deck mixing faucet with 12" double joint swing nozzle
P	51848	Deck mixing faucet with 18" swing nozzle
Q	15629	Deck mixing faucet with 12" swing nozzle
R	51849	Deck mixing faucet with 6" swing nozzle
S	51850	Sink mixing faucet with 18" swing nozzle
T	51851	Sink mixing faucet with 12" swing nozzle
U	51852	Sink mixing faucet with 6" swing nozzle
V	51853	Sink mixing faucet with 6" swing nozzle and soap dish
W	51854	Sink mixing faucet with 6" cast nozzle
X	51855	Combo sink faucet with 18" double joint swing nozzle
Y	51856	Combo sink faucet with 15" double-joint swing nozzle
Z	51857	Combo sink faucet with 12" double-joint swing nozzle
AA	51855	Combo sink faucet with 10 1/4" high rigid gooseneck spout
AB	51859	Combo sink faucet with 9 1/4" high swivel gooseneck spout
AC	29112	Combo sink faucet with 18" swing nozzle
AD	29113	Combo sink faucet with 12" swing nozzle
AE	29114	Combo sink faucet with 6" swing nozzle

**WE CAN MIX & MATCH
ALL FAUCETS WITH ALL
SPOUTS!**

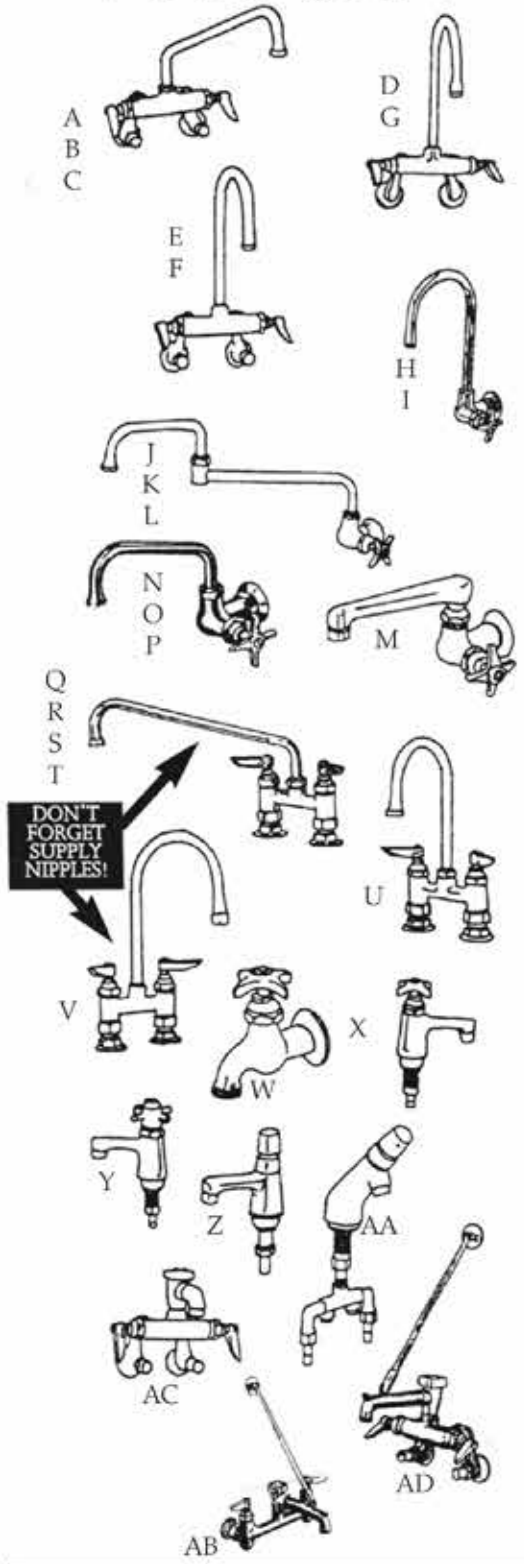

FIG. NO.	DESCRIPTION
A 29115	Combo sink faucet 18" swing nozzle with integral stops
B 29116	Combo sink faucet 12" swing nozzle with integral stops
C 29117	Combo sink faucet 6" swing nozzle with integral stops
D 29165	Combo sink faucet with 10 1/4" high rigid gooseneck spout
E —	Combo sink faucet with 9 1/4" high swivel goose neck spout with integral stops
F —	Combo sink faucet with 10 1/4" high rigid gooseneck spout with integral stops
G 29168	Combo sink faucet with 9 1/4" high swivel gooseneck spout
H 60573	Single sink faucet with 10 3/4" high rigid goose-neck spout
I 29161	Single sink faucet with 9 3/4" high swivel goose-neck spout
J 29128	Single sink faucet with 18" long double-joint swing nozzle
K 29129	Single sink faucet with 15" long double-joint swing nozzle
L 29130	Single sink faucet with 12" long double-joint swing nozzle
M 28928	Single sink faucet with 6" cast nozzle
N 51860	Single sink faucet with 18" swing nozzle
O 51861	Single sink faucet 12" swing nozzle
P 51862	Single sink faucet 6" swing nozzle
Q B-225	Deck mixing faucet with 12" swing nozzle
R B-226	Deck mixing faucet with 10" swing nozzle
S B-227	Deck mixing faucet with 8" swing nozzle
T B-228	Deck mixing faucet with 6" swing nozzle
U 15639	Deck mixing faucet with 11 3/4" swivel gooseneck spout
V 248296	Deck mixing faucet with 12" rigid gooseneck spout
W 29365	Single sink faucet with 1/2" IPS female inlets
X 29375	Single basin faucet
Y B-711	Single basin faucet with self-closing valve
Z 29378	Single basin faucet with self-closing valve, push button.
AA 29399	Slow self-closing mixing faucet
AB 29087	Service sink faucet with Vacuum breaker and brace
AC 32105	Service sink faucet with vacuum breaker
AD 29331	Service sink faucet with vacuum breaker and brace

T&S BRASS FAUCETS AND FITTINGS



FIG. NO.	DESCRIPTION
A 51825	Dble pantry faucet w/ 13"high rigid gooseneck spout
B 51826	Dble pantry faucet w/ 12"high swivel nozzle
C 51827	Double pantry faucet with 18"swing nozzle
D 51828	Double pantry faucet with 12"swing nozzle
E 51840	Double pantry faucet with 6"swing nozzle
F 29122	Double pantry faucet with 18"double-joint swing nozzle
G 29123	Double pantry faucet with 15"double-joint swing nozzle
H 32165	Lav faucet slow self-close w/ pop-up 8"center
I 32163	Lav faucet slow self-close L/ pop-up 8"center
J 32179	Lav faucet with pop-up, 8"center
K 18518	Service sink faucet with vacuum breaker
L 29385	Sill faucet with 1/2"female inlet; 3/4" hose outlet and loose key
M 32118	Sill faucet with 1/2"female inlet; 3/4" hose outlet, vacuum breaker and loose key
N 29434	Centerset lav faucet with pop-up drain
O 29725	Centerset lav faucet less pop-up drain
P 15708	Pre-rinse spray with flex stainless steel hose
Q 29467	Flex stainless steel hose w/ self closing spray valve
R 15709	Pre-rinse spray
S 28868	Pre-rinse spray w/ fan jet knife action spray vlv
T 15719	Pre-rinse unit with deck mount valve
U 28902	Pre-rinse unit with wall mount valve
V 29295	Pre-rinse unit with wall mount valve & nozzle
W	Pot and kettle filler, wall mount w/ single temp control
X 29297	Pot & Kettle Filler, wall mount, 8"centers
Y 15717	Add-on faucet for use w/ pre-rinse units (6" nozzle)
Z 28889	Add-on faucet for use w/ pre-rinse units (12" nozzle)
AA 28890	Add-on faucet for use w/ pre-rinse units (18" nozzle)
AB 15710	Repair kit for B-07 spray valve (FIG NO 15710)
AC 31041	Wall bracket
AD 28841	Brush Attachment
AE 28864	Dummy wall hook
AF 28893	Dummy wall hook
AG 31303	3/8" IPS adapter for pre-rinse units
AH 55A	1/2" IPS adapter for pre-rinse units
AI 29143	Deck faucet with 12"swing nozzle
AJ 51809	Workboard faucet, 4"CC w/ 6"swing nozzle
AK 51810	Workboard faucet, 4"CC w/ 8"swing nozzle
AL 51811	Workboard faucet, 4"CC w/ 10"swing nozzle
AM 31603	44"Hose w/ vacuum breaker

DUFFNOTE:

DUFF has the largest T&S Brass selection in the region, so let us help you configure the T&S faucet to fit your application.

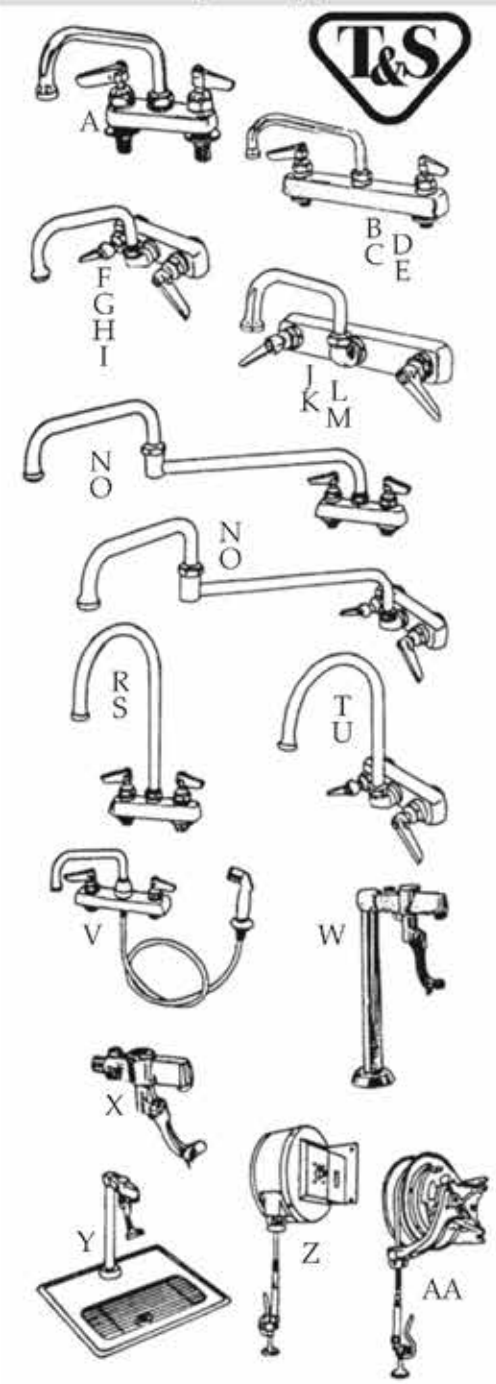

FIG. NO.	DESCRIPTION
A 51812	Workboard faucet, 4"CC with 12" swing nozzle
B 51817	Workboard faucet, 8"CC w/ 6" swing nozzle
C 51818	Workboard faucet, 8"CC w/ 8" swing nozzle
D 51819	Workboard faucet, 8"CC with 10" swing nozzle
E 518120	Workboard faucet, 8"CC with 12" swing nozzle
F 51813	Workboard wall mount faucet, 4"CC with 6" swing nozzle
G 51814	Workboard wall mount faucet, 4"CC with 8" swing nozzle
H 51815	Workboard wall mount faucet, 4"CC with 10" swing nozzle
I 51816	Workboard wall mount faucet, 4"CC with 12" swing nozzle
J 51821	Workboard wall mount faucet, 8"CC with 6" swing nozzle
K 51822	Workboard wall mount faucet, 8"CC with 8" swing nozzle
L 51823	Workboard wall mount faucet, 8"CC with 10" swing nozzle
M 51824	Workboard wall mount faucet, 8"CC with 12" swing nozzle
N 29641	Workboard deck mount faucet, 4"CC with 18" Double-joint swing nozzle
O 29642	Workboard deck mount faucet, 8"CC with 18" Double-joint swing nozzle
P 29644	Workboard wall mount faucet, 4"CC with 18" Double-joint swing nozzle
Q 29645	Workboard wall mount faucet, 8"CC with 18" double-joint swing nozzle
R 44280	Workboard deck mount faucet, 4"CC with 9 1/4" high swivel gooseneck spout
S 39213	Workboard deck mount faucet, 8"CC with 9 1/4" high swivel gooseneck spout
T 29649	Workboard wall mount faucet, 4"CC with 9" high swivel gooseneck spout
U 29650	Workboard wall mount faucet, 8"CC with 9" high swivel gooseneck spout
V 29658	sink faucet with auto diverter vinyl hose, 8"CC and 8" swing nozzle
W 29666	Pedestal type push back glass filler
X 29663	Push back glass filler, wall mount
Y 29680	Water station system complete
Z 29687	Reel clean enclosed model with 35" hose
AA 29688	Reel clean open model with 35" hose

REMEMBER, WE CAN SUPPLY ALL TYPES OF HANDLES AND SPOUTS ON ALL TYPES OF FAUCETS!

T&S BRASS HOSPITAL and MEDICAL FITTINGS



**DON'T FORGET
SUPPLY
NIPPLES!**

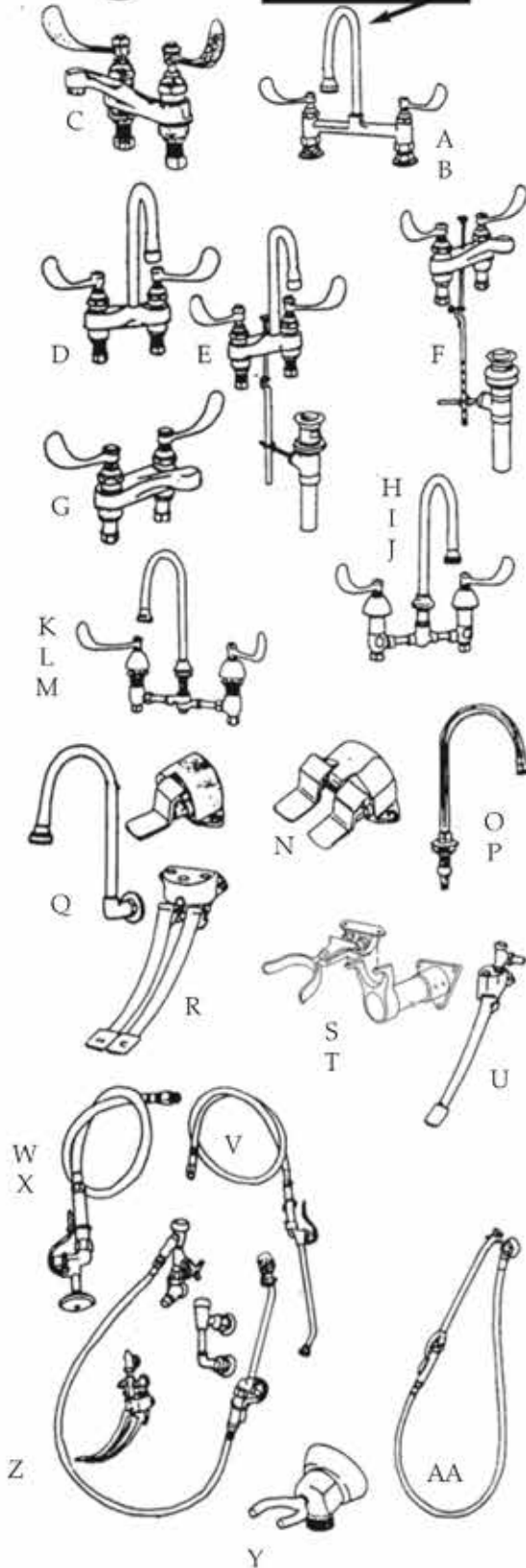
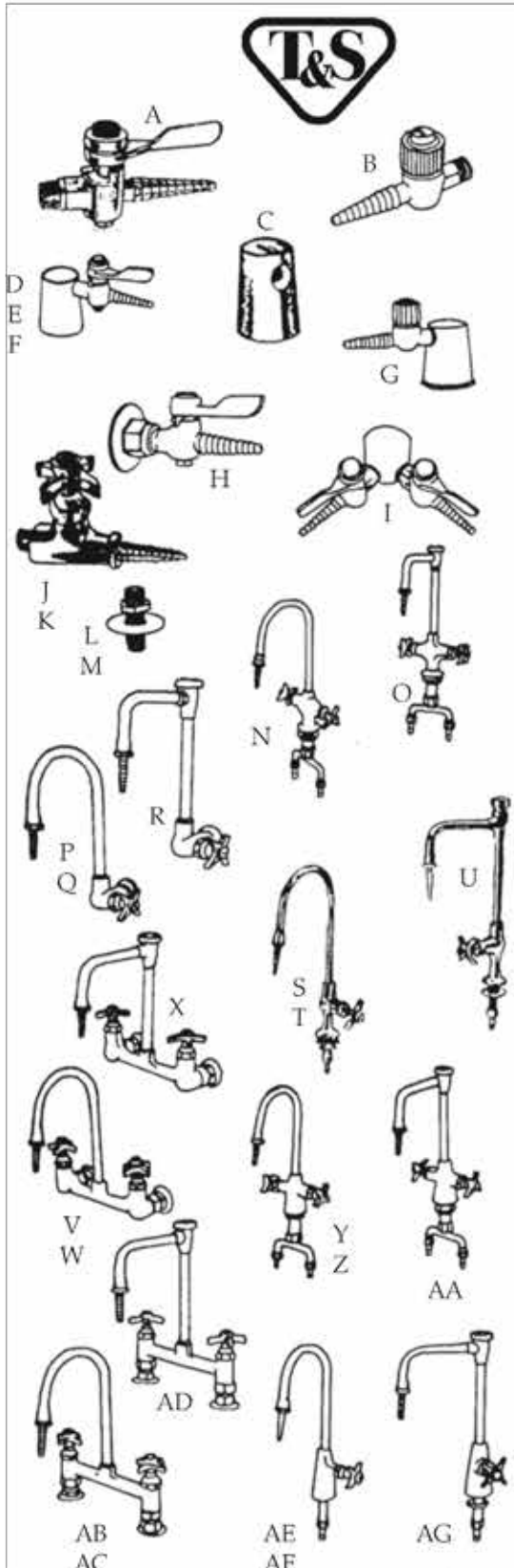

FIG. NO.	DESCRIPTION
A 18334	Surgical sink faucet, 8" CC w/ 9" rigid goose-neck spout w/ rosespray
B 32082	Surgical sink faucet, 8" CC with 9" rigid goose-neck spout with stream regulator
C 29444	Medical lavatory faucet, 4" CC with 4" wrist blade handles with aerator
D 29446	Medical lavatory faucet, 4" CC with 8 3/4" gooseneck spout & wrist blade handles
E 28364	Medical lavatory faucet, 4" CC with 4" wrist blade handles and pop-up drain
F 29449	Medical lavatory faucet, 4" CC with 4" wrist blade handles and pop-up drain
G 29448	Medical lavatory faucet, 4" CC with 4" wrist blade handles less pop-up drain w/drip-proof spray face
H 417892	Medical lavatory faucet 8" CC with 9 3/4" high rigid gooseneck spout
I 41785	Medical lavatory faucet 8" CC with 9 3/4" high swivel gooseneck spout
J 41788	Medical lavatory faucet 8" CC with 9 3/4" high swivel gooseneck spout with aerator
K 18807	Medical lavatory faucet 8" CC with 9 3/4" high rigid gooseneck spout
L 29424	Medical lavatory faucet 8" CC with 9 3/4" high swivel gooseneck spout
M 29429	Medical lavatory faucet 8" CC with 9 3/4" high swivel gooseneck spout with aerator
N 15662	Double pedal valve, floor mounted
15663	Single pedal valve, floor mounted
O 15664	Rigid 10" high gooseneck spout, deck mount
P 29259	Rigid 10" high gooseneck spout, deck mount with aerator
Q 15666	Rigid 9 3/4" high gooseneck spout, wall mounted
R 29247	Double pedal valve, wall mount
S B-475	Knee action valve
T B-473	Wall support for knee action valve
U 29256	Single pedal valve, wall mount with straight stops
V 29352	Bedpan washer with self-closing spray valve and rubber hose
W 29467	Bedpan washer with self-closing spray valve and stainless steel hose
X 29468	Bedpan washer with self-closing valve and rubber hose
Y 28862	Wall hook and flanged water supply elbow
Z 29341	Bedpan washer system with pedal valves and vacuum breaker
AA 29344	Bedpan washer



ALL SPOUTS AVAILABLE
RIGID OR SWIVEL

FIG. NO.	DESCRIPTION
A 36239	Ground key hose cock with 3/8" IPS male inlet
B 79877	Needle valve w/serrated tip w/3/8" IPS male inlet
C 36235	Lab turret 3/8" IPS female inlet and 3/8" side outlet
D 15673	Turret with hose cock, 3/8" IPS Female inlet
E 15675	Turret w/ hose cock, 3/8" IPS Female inlet & two 180 degree outlets
F 15677	Turret w/ hose cock, 3/8" IPS Female inlet & four outlets
G 79881	Turret with needle valve, 3/8" IPS Female inlet
H 15678	Panel flange w/ hose cock, 3/8" IPS Female inlets
I 15679	Double panel flange with two hose cocks, 3/8" IPS Female inlets
J 15680	Straight stop with 3/8" Male IPS inlet
K 19739	Straight stop with 3/8" Male IPS inlet with Eterna construction for water
L 15685	Supply nipple & lockout for panel mountings, 3/8" IPS
M 36238	Supply nipple & lockout for deck mountings, 3/8" IPS
N 72118	Double ledge faucet w/ 13" high gooseneck spout
O 32988	Double ledge faucet with 13" vacuum breaker, high gooseneck spout
P 79883	Single sink fct w/ 10 3/4" rigid gooseneck spout
Q 79884	Single sink fct w/ 11 1/2" swivel gooseneck spout
R 79885	Single sink faucet w/ 10 1/4" vacuum breaker gooseneck spout
S 47127	Single ledge faucet with 13 1/4" rigid gooseneck spout
T 39215	Single ledge faucet w/ 13 3/4" swivel gooseneck spout
U 80178	Single ledge faucet with 12 3/4" vacuum breaker gooseneck spout
V 79892	Sink mixing faucet w/ 11" rigid gooseneck spout
W 38560	Sink mixing faucet w/ 11" swivel gooseneck spout
X 79893	Sink mixing faucet with 11" vacuum breaker high gooseneck spout
Y 79894	Double ledge faucet w/ 13" rigid gooseneck faucet
Z 79895	Double ledge faucet w/ 13" swivel gooseneck faucet
AA 79898	Double ledge faucet with 13" vacuum breaker gooseneck faucet
AB 79899	Ledge mixing faucet w/ 13" rigid gooseneck spout
AC 79900	Ledge mixing faucet w/ 13" swivel gooseneck spout
AD 32839	Ledge mixing faucet with 13" vacuum breaker gooseneck spout
AE 43766	Single sledge faucet w/ 13 1/4" rigid gooseneck spout
AF 79902	Single ledge faucet w/ 13 3/4" swivel gooseneck spout
AG 32809	Single ledge faucet with 12 3/4" vacuum breaker gooseneck spout

T&S BRASS SPOUTS

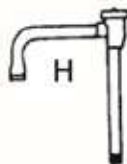
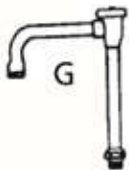
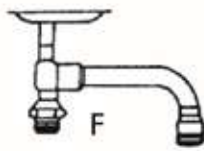
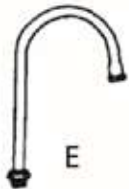
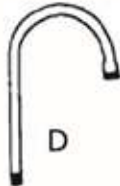
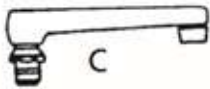
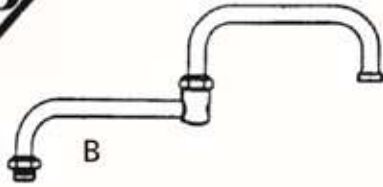
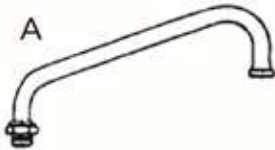





FIG. NO.	DESCRIPTION
A	31838 6" swing nozzle
	15589 8" swing nozzle
	17552 10" swing nozzle
	15592 12" swing nozzle
	15594 14" swing nozzle
	15595 16" swing nozzle
B	15596 18" swing nozzle
	15597 6" double joint swing spout
	15598 9" double joint swing spout
C	15600 18" double joint swing nozzle
	15602 6" cast swing nozzle
D	15605 2 3/4" center to center by 8" high rigid gooseneck spout
	32055 5 3/4" center to center by 9 1/2" high rigid gooseneck spout
	15608 5 3/4" center to center by 11 1/2" high rigid gooseneck spout
	15609 5 3/4" center to center by 12 1/2" high rigid gooseneck spout
	15612 5 3/4" center to center by 10 3/4" high rigid gooseneck spout
	15736 2 3/4" center to center by 8" high rigid gooseneck spout
E	15737 2 3/4" center to center by 8 3/4" high rigid gooseneck spout
	15738 5 3/4" center to center by 8 3/4" high rigid gooseneck spout
	15739 8 3/4" center to center by 11 3/4" high rigid gooseneck spout
	15604 6" soap dish swing nozzle
F	28224 8" soap dish swing nozzle
	28225 12" soap dish swing nozzle
	49688 Swivel vacuum breaker gooseneck spout 5 3/4" reach x 9 1/2" high
G	28244 Swivel vacuum breaker gooseneck spout 8 3/4" reach x 9 1/2" high
	28245 Swivel vacuum breaker gooseneck spout 11 3/4" reach x 9 1/2" high
	H 49687 Vacuum breaker gooseneck 5 3/4" reach X 9 1/4" high
I 28308 Atmospheric back flow preventer 3/8" IPS Female inlet	













All spouts are available on all faucets!
 Please call or email us at info@duffco.com

T&S BRASS CONVERSION ADAPTERS

		FIG. NO.	MODEL NO.	DESCRIPTION
		15740	B-412	Rigid to swivel adapter
		15741	B-413	Swivel to rigid adapter
		15742	B-414	Gooseneck coupling









T&S BRASS HANDLES (SOLD EACH)

		51998	B-WH-4	Wrist action handle 4"
28770		28770	B-WH-6	Wrist action handle 6"
		15573	175F	4-arm faucet handle
59-40		59-40	59-40	4-arm lab handle
		31581	76F	Alpine handle
31592		31592	209L-CW	Cold water index button
		31593	209L-H	Hot water index button
15688		15688	25F	Handle screw
		15750	178F	Lever handle
31592		31592	178F	Lever handle
31593		31593	178F	Lever handle

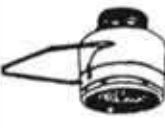

Handles are interchangeable! Please call or email us at info@duffco.com

T&S BRASS AERATORS

		28255	B-199-2	Non-splash aerator, 55/64" Female aerator threads
		28256	B-199-3	Non-splash aerator, 3/8" IPS Male threads for goosenecks
		28258	B-199-6	Non-splash aerator, 13/16" Male threads for lav spouts
		28260	B-199-7	Vandal proof non-splash aerator, 55/64" Female aerator threads
		28272	B-GFE	Vandal proof non-splash aerator 13/16" male threads
15743		15743	B-GH	Garden hose outlet, 55/64 Female aerator threads
		15745	B-103	Garden hose outlet 3/8" IPS Male threads
				Rosespray

T&S BRASS MISCELLANEOUS PARTS

**CAN BE CUSTOM MADE
TO ANY LENGTH!**

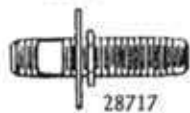
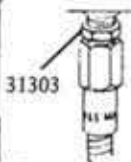
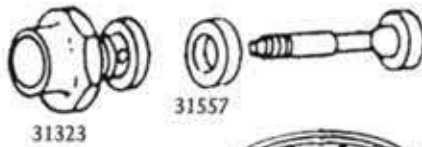

19651

28717

FIG. NO.	MODEL NO.	DESCRIPTION
15715	B-44H	Flexible stainless steel hose
31061	B-44R	Reinforced rubber hose
28836	B-68H	Stainless steel hose for bedpan washer
31071	B-68R	Reinforced rubber hose
31323	608-25	Bonnet for spray valve
31557	1084-45	Seat washer for spray valve
	842-20	Stem for pre-rinse unit
15713	1121-45	Spray face for pre-rinse unit
31454	913-45	Screw for spray face on b-107 pre-rinse unit
31370	753-25	Push button for spray valve
	885-45	Bonnet spring
31567	1097-45	Packing for spray valve
15697	1015-45	Washers for bedpan washer
31529	1040-45	Binding washer for spray valve
31488	974-45	Washer for pre-rinse unit
31827	2865-40	Spray valve for pre-rinse unit
15712	7861-45	Rubber ring for B107
15698	1120-45	Squeeze down handle for pre-rinse unit
31872	2987-40	Plastic handle for pre-rinse unit
31303	545-25	Hose adapter for work board faucets
28274	B-198F	Low splash serrated tip
	B-198	Serrated tip
31785	2714-40	Hot cartridges
31784	2713-40	Cold cartridges
31041	B-109-1	Wall bracket 6"
28870	B-109-2	Wall bracket 9"
19651	B-425	Supply nipple 1/2" x 2"
28717	B-426	Supply nipple 1/2" x 3 3/8"

T&S BRASS MISCELLANEOUS PARTS



Spray hose adapter - Permits T&S spray hoses to be adapted to Fisher spray hoses.

FIG. NO.	PRICE
61267	



T&S self-closing stem assemblies. Fits all "ETERNA" models.

FIG. NO.	PRICE
Cold 31841	
Hot 31840	



Replacement glass filler arms.

FIG. NO.	PRICE
31584	



T&S Spanner Wrench.

FIG. NO.	PRICE
31719	



T&S Index Button, Cold Water. Blue button marked C.W. for wrist action and cross handles. Button snaps in and is vandal resistant.

FIG. NO.	PRICE
cold 28783	
hot 28784	



T&S Index Button, Cold Water for wrist action and cross handles. Red button marked H.W. (hot water). Green button Marked C.W. (cold water) for use in laboratories. Button snaps in and is vandal resistant. Specify service required.

FIG. NO.	PRICE
Hot Water 31593	
Cold Water 31592	



T&S 238A Cartridge. Specify Hot, Cold or blank.

HANDLES	
FIG. NO.	PRICE
#15 COLD 31841	
#15 HOT 31840	
Blanks also available	



T&S Service Index. Blue service index for cold water. Fits T&S lever and Lavatory handles.

FIG. NO.	PRICE
28781	



T&S Service Index. Same as 28781 but red for hot water service.

FIG. NO.	PRICE
28782	



T&S swivel arm assembly. 12" length. For use on Fig No's 15720, 28875, 28879, 28880, 28882, 28883, 28885, 28886, 28898 and 28899

FIG. NO.	PRICE
31845	

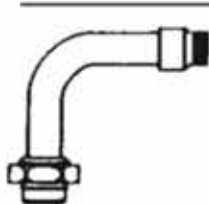

Swivel adapter used with T&S spray hose.

FIG. NO.	PRICE
31824	

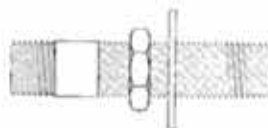

T&S faucet inlet nipple and locknut. converts faucets from female to male inlets. Brass.

SIZE	FIG. NO.	PRICE
1/2 X 2	19651	
1/2 X 3 3/8	28717	
3/4 X 2 1/2	28718	
2/8 X 2 1/8	28719	
3/8 X 3 3/8	28721	

T&S FOOT AND KNEE VALVE PARTS.



- 1 Bonnet Assembly
- 2 Push Button
- 3 Spring
- 4 bonnet washer
- 5 Packing
- 6 Bonnet Body
- 7 Binding washer
- 8 Seat washer
- 9 Stem

ALL PARTS AVAILABLE IN BULK!

COMPLETE UNIT

DESCRIPTION	
(1) Complete Bonnet Assembly	
FIG. NO.	PRICE
15699	

T & S BRASS

**ALL PARTS
AVAILABLE IN BULK!**

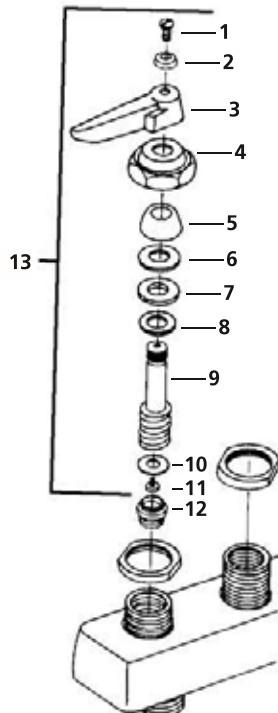

T&S Faucet Parts for 1100 series faucet stem parts.

- 1 Screw
- 2 Cold index button
- 2 Hot index button
- 3 Cold handle
- 3 Hot handle
- 4 Bonnet
- 5 Packing
- 6 Stainless steel washer
- 7 Rubber washer
- 8 Brass washer
- 9 cold stem
- 9 Hot stem
- 10 Seat washer
- 11 Seat washer screw
- 12 Removable seat

C O M P L E T E U N I T

DESCRIPTION	FIG. NO.	PRICE
(13) Cold stem assembly	31780	
(13) Hot stem assembly	31781	

ETERNA STEM PARTS

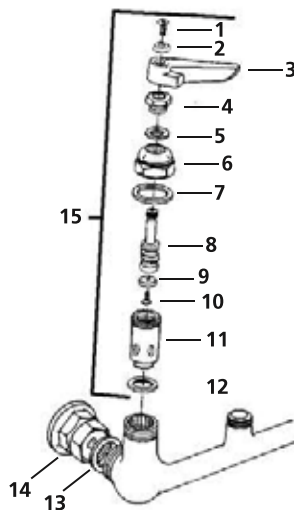

- 1 Screw
- 2 cold index button
- 2 Hot index button
- 3 cold handle
- 3 Hot handle
- 4 packing nut
- 5 Packing
- 6 Bonnet
- 7 Bonnet gasket
- 8 Cold stem
- 8 Hot stem
- 9 Seat washer
- 10 Seat washer screw
- 11 Cold insert
- 11 Hot insert
- 12 Seat gasket
- 13 Washer
- 14 Coupling flange

**ALL PARTS
AVAILABLE IN BULK!**

DESCRIPTION	FIG. NO.	PRICE
(15) Eterna Cold stem ass	31784	
(15) Eterna Hot stem ass	31785	

**PRE-RINSE PARTS AND
ACCESSORIES**

- 1 Spring
- 2 Spring Body
- 3 18" Riser tube
- 3 24" Riser tube
- 3 32" Riser tube
- 4 Finger hook and screw
- 5 Deck mount base faucet
- 6 Washer
- 7 Spreader assembly
- 8 Wall mount base faucet
- 9 Tailpiece
- 10 Tailpiece nut

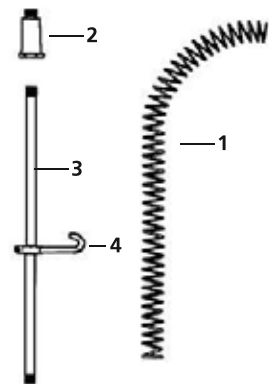

**ASK YOUR DUFF
SALESPERSON
FOR PRICING
AND
AVAILABILITY!**

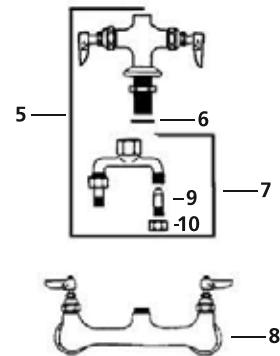

PRE-RINSE PARTS AND ACCESSORIES

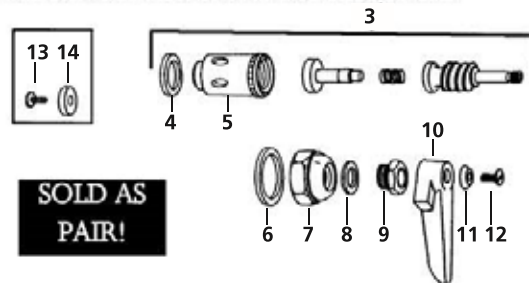

**SOLD AS
PAIR!**

- 4 Seat gasket
 - 5 Removable insert - cold
 - 5 Removable insert - hot
 - 6 Bonnet gasket
 - 7 Bonnet
 - 8 Packing
 - 9 Packing nut
 - 10 cold handle
 - 10 Hot handle
 - 11 Hot index button
 - 12 Handle screw
 - 13 Seat screw for older stems
 - 14 seat washer for older stems
- ASK YOUR DUFF SALESPERSON FOR PRICING AND AVAILABILITY!**

**ALL PARTS
AVAILABLE IN BULK!**

DESCRIPTION	FIG. NO.	PRICE
(3) Cold & Hot stem ass	41767	

T&S BRASS REPAIR KITS

**B-12K
Spindle Kit**

Right hand spindle insert, left hand spindle insert, 2 screws, 2 seat washers



FIG. NO.	PRICE
41737	

**B-13K
Spindle Kit**

Right hand spindle insert, left hand spindle insert



FIG. NO.	PRICE
41739	

**B-16K
B-0101 Push Button Valve Kit**



1 spring
2 bonnet washers
2 hose washers
2 cap washers
2 seat washers
2 packing stems

FIG. NO.	PRICE
28810	

**B-17K
Old Style B-0230 Spindle Kit**

Right hand spindle, left hand spindle, 2 seat screws, 2 seat washers



FIG. NO.	PRICE
41760	

**B-18K
Four Arm Handle Kit - Lab**



2 each four arm handles, 2 handle screws, 1 snap-in red index button (hot), 1 snap-in green index button (cold)

**B-19K
Four Arm Handle Kit - Kitchen**



2 four arm handles, 2 handle screws, 1 red index button, 1 blue index button

**B-21K
Eterna Cartridge Replacement**

1 right hand removable insert assembly, 1 left hand removable insert assembly



FIG. NO.	PRICE
44995	

**B-10K
Repair Kit for B-0107**



2 each rubber rings, seat washers, binding washers, bonnet washers, packings, springs and hose washers

FIG. NO.	PRICE
15710	

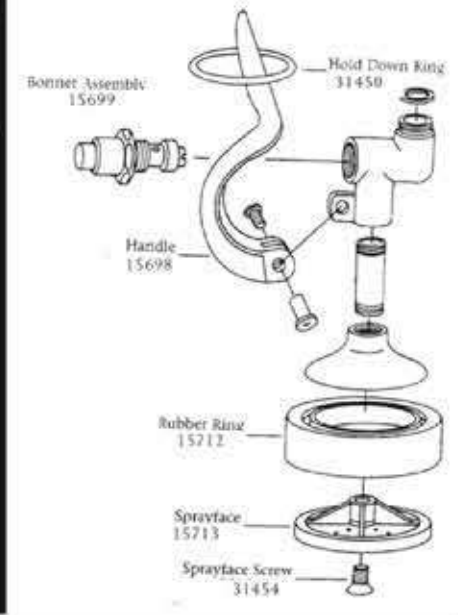

T&S BRASS REPAIR KITS

B-23K Spring Check Spindle Ass Replacements

1 each left hand
Eterna spindle with
spring check,
1 each right hand
Eterna spindle with
spring check



FIG. NO.	PRICE
41767	

B-1255 Glass Filler Repair Kit



2 springs, 1 handle screw, 1 handle nut, 2
bonnet washers, 2 hex cap washers, 2 seat
washers, 2 stem packings, 1 lever arm

FIG. NO.	PRICE
29678	

B-30K Range Faucet Parts Kit



1 spring, 4 O-rings (00625-45),
2 O-rings (00009267-45), 2 O-rings (009628-45),
2 bearings

B-50P Foot Pedal Valve Parts Kit

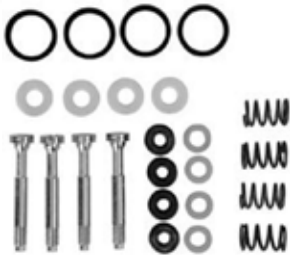

4 valve stems, 4 springs, 4 bonnet washers
(000974-45), 4 bonnet washers (000633-45),
4 seat washers, 4 packing stems

FIG. NO.	PRICE
15702	

B-5K B-230 Faucet Repair Kit



Right hand
spindle, left hand
spindle, 6 seats,
6 seat screws,
12 washers,
12 bonnet washers
(009635-45),
12 bonnet washers
(00726-45),
24 O-rings,
12 washers,
12 dome packings

FIG. NO.	PRICE
28805	

B-6K Eterna Spindle Parts Kit



Right hand Eterna
Insert, left hand
Eterna insert, right
handle spindle
insert, left handle
spindle insert,
seat washer screw,
bottom gasket,
top gasket,
seat washer,
packing, washer,
D-ring

FIG. NO.	PRICE
28806	

B-7K Master Parts Kit



12 right hand
Eterna Inserts,
6 left hand
Eterna inserts,
12 right handle
spindle inserts,
6 left handle
spindle inserts,
6 packing nuts,
50 lever handle
screws, 25 seat
washers,
25 top gaskets,
25 swing nozzle
O-rings,
50 seat washers,
50 packings

FIG. NO.	PRICE
28807	

B-9K Lever Handle Kit



Lever handle Hot, lever handle Cold,
index button Hot (red),
index button Cold (blue),
2 lever handle screws

FIG. NO.	PRICE
41830	

B-11K Eterna Cartridge Spindle Kit



Right hand spindle insert,
left hand spindle insert,
2 screws,
2 seat washers,

FIG. NO.	PRICE
43163	



KITCHEN FAUCETS



CENTRAL BRASS wall mount combination faucet with 6" standard spout

DESCRIPTION	FIG. NO.	PRICE
Female Fem w/ 12" spout	7970	
Male Male w/ 8" spout	7936	
Male Male w/ 12" spout	7958	



CENTRAL BRASS two handle kitchen faucet 8" center.

FIG. NO.	PRICE
7859	



CENTRAL BRASS 2 handle kitchen faucet with spray, 8" center.

FIG. NO.	PRICE
7895	



6" Center

CENTRAL BRASS Deck faucet. Replaces Sears, Rundle.	
FIG. NO.	PRICE
7931	

For fastest delivery, email us at info@duffco.com or fax us at 610-279-6299



LAVATORY FAUCETS



CENTRAL BRASS 2 handle 4" centerset faucet

LESS POP-UP	
FIG. NO.	PRICE
7749	
WITH POP-UP	
7751	

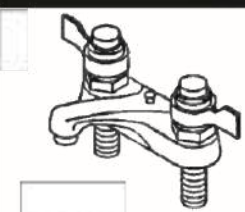

CENTRAL BRASS self-closing, 4" centerset lav faucet

LESS POP-UP	
FIG. NO.	PRICE
7758	
WITH POP-UP	
7760	



CENTRAL BRASS widespread lav faucet on 6" - 24" centers

LESS POP-UP	
FIG. NO.	PRICE
7779	
WITH POP-UP	
7782	



CENTRAL BRASS shelf-back faucet with pop-up 4" - 6" adjustable.

FIG. NO.	PRICE
7812	

BASIN COCKS

CENTRAL BRASS heavy duty basin cock.



	FIG. NO.	PRICE
HOT	44596	
COLD	7761	



CENTRAL BRASS slow-close basin cock

FIG. NO.	PRICE
7769	



CENTRAL BRASS self-close basin cock

FIG. NO.	PRICE
7763	



CENTRAL BRASS sink wall bibb.

	FIG. NO.	PRICE
HOT	37971	
COLD	37970	

FAUCETS BY CENTRAL BRASS

TUB AND SHOWER FAUCETS



CENTRAL BRASS 2 handle tub filler.

FIG. NO.	PRICE
8207	



CENTRAL BRASS 2 valve shower only.

FIG. NO.	PRICE
8211	



CENTRAL BRASS 8" tub shower diverter.

FIG. NO.	PRICE
8" 8222	
11" 20642	



MISCELLANEOUS FAUCETS

TOPMOUNTED BAR/LAUNDRY FAUCET

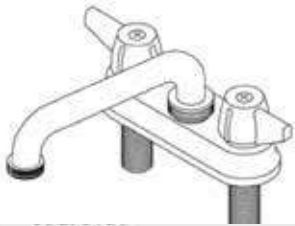

8033

COMBINATION BAR FAUCET



For single hole mounting.

FIG. NO.	PRICE
46860	

SERVICE SINK FAUCET



CENTRAL BRASS back-mount service sink faucet. Rough Chrome.

ADJUSTABLE ARM BATH COCK



Bath faucet with cast brass body. Arms adjust from 2 1/2" to 8 1/2". Top handle. Chrome plated.

FIG. NO.	PRICE
24409	

TRIP WASTES



TRIP LEVER TUB DRAIN

FIG. NO.	PRICE
8312	



USE WHEN FLOOR JOIST BLOCKS PATH!

SIDE OUTLET DRAIN pop-up drain with side outlet drain. Chrome plated trim.

FIG. NO.	PRICE
20710	



CENTER LIFT TUB DRAIN

FIG. NO.	PRICE
19008	



ALSO AVAILABLE IN 1-3/8!"

CHAIN & STOPPER BATH DRAIN. 1 1/2" Multi-Tub Brass face plate Chrome plated trim

CENTRAL BRASS PARTS

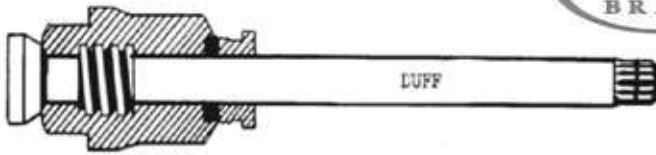

Central Shower Stem Assembly

FIG. NO.	PRICE
8582	

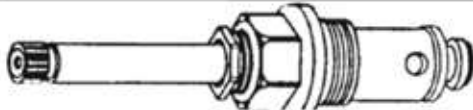

Central diverter Stem Assembly

FIG. NO.	PRICE
8583	

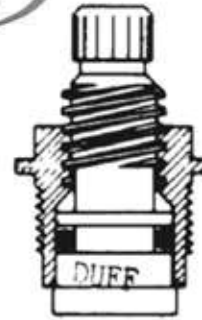

Central Lav Stem

FIG. NO.	PRICE
HOT	8604
COLD	37889

CENTRAL BRASS WASHERLESS SYSTEM ALSO AVAILABLE



Central brass tub handles. Chrome plated canopy, screws included.

Central brass lav or sink handles. Chrome plated canopy lever, screws included.



FIG. NO.	PRICE
HOT	8618
COLD	44648

CENTRAL BRASS 3127 LAV FAUCET PARTS BREAK DOWN

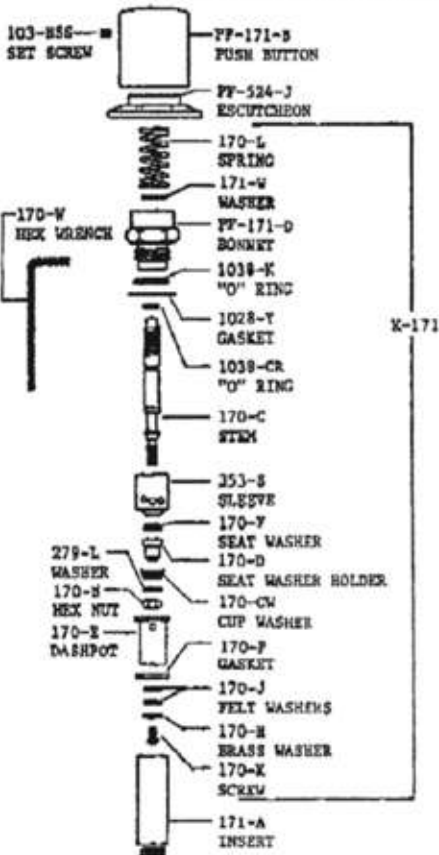

CENTRAL BRASS REPLACEABLE HANDLES

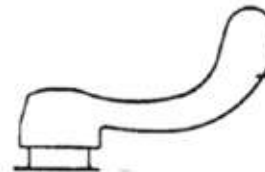

FIG. NO.	PRICE
6" Elbow Handle	
8633	
4" Wrist Handle	
8632	

PLEASE SPECIFY HOT OR COLD INDEX WHEN ORDERING!

FIG. NO.	PRICE
8616	

CENTRAL BRASS REPLACEABLE SEAT 1/2 x 24

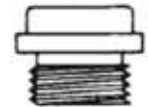

FIG. NO.	PRICE
8599	



CENTRAL BRASS SPOUTS

8" SWIVEL TUBE SPOUT WITH AERATOR



SIZE	FIG. NO.	PRICE
8"	8610	
10"	8607	
12"	8608	
14"	8609	

5" CAST BRASS SWIVEL SPOUT WITH AERATOR

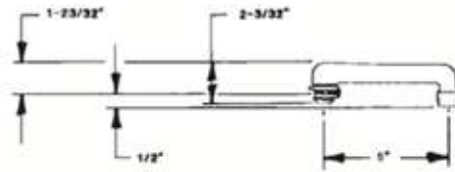

FIG. NO.	PRICE
8628	

7" CAST BRASS SPOUT EXTENSION POLISHED CHROME

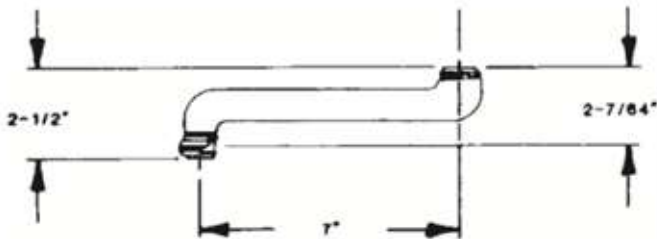
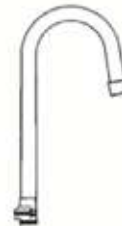

FIG. NO.	PRICE
SU-2775-R-02	

SWIVEL GOOSENECK SPOUT WITH AERATOR



SIZE	FIG. NO.	PRICE
4-3/32"	8595	
6-1/2"	35785	

BRASS SWIVEL "D" SPOUT WITH AERATOR

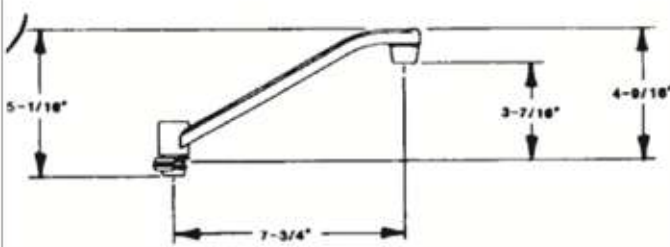

FIG. NO.	PRICE
8611	

7-1/4" SWIVEL HIGH RISE SPOUT WITH AERATOR

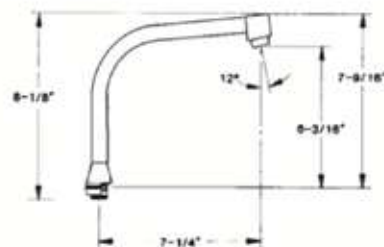

FIG. NO.	PRICE
48540	

DUFF DIFFERS



POWERS MIXING VALVES

HydroGuard T/P Series e420 Combination Tempering Valves

Concealed thermostatic water mixing valve for use on shower and tub/shower installations. Advanced thermal actuator compensates for both temperature and pressure fluctuations. A built-in adjustable metal-to-metal temperature limit stop reduces chances of accidental scalding. Heavy cast-brass body, integral checkstops, durable brass faceplate, lever-type handle, and corrosion-resistant material ensure years of trouble-free service.



Biltmore Series 900 Pressure-Balancing Valves Model 3

This is a pressure-balancing mixer delivering a predetermined mix of hot and cold water by compensating for pressure fluctuations in the hot and cold water supplies. It features a poppet design valve as part of a replacable balancing cartridge. The poppet design has two distinct advantages: 1. it won't stick due to build-up of foreign particles; 2. quick reaction time.

Safety Feature: Should either supply fail, the BILTMORE reduces the flow of water to prevent a continued spray of all hot or cold water.



HydroPanel II With HydroGuard e420

- e420 temperature/pressure combination valve quickly compensates for both pressure and temperature changes
- Metal-to-metal limit stop limits handle rotation ensuring safe water delivery temperature
- ADA compliant lever handle and color coded dial for quick and easy temperature selection
- Brushed stainless steel surface for cleaning and maintenance
- Optional modular shrouding offers convenient configuration of horizontal and vertical panel
- Available with or without stainless steel soap dish
- Brackets included for easy installation.



Central Mixer — #11A Regulator

Self-contained regulator provides protection for the entire hot water system. The No. 11 can be located at the central water heater to permit storing water at higher temperatures and then reducing the temperature for safe hot water supply to building fixtures. The No. 11 is self-actuated and requires no external power source. In addition to the three-way water mixing configuration, it is available with a variety of seat styles and materials for use with two-way No. 11 regulators to control supply of a heating medium, such as steam. Three-way valve also available.



FotoGuard/FotoPanel

These fixtures include HydroGuard T/P® e420 Series Thermostatic Valves. Once the temperature and volume controls are adjusted, only the ON/OFF switch is used to start or stop the process. Dial thermometer with external recalibration screw continuously indicates water temperature; vacuum breaker in outlet prevents backflow; furnished with union strainer checkstops for 1/2" (15mm) inlets. Stainless steel cabinet for wall or deck mounting. Three different models available.



AQUASENTRY 2® Temperature Alarm System

The Series LF460 AquaSentry2® Alarm System monitors mixed outlet temperature for pre-set high and low conditions utilizing a solid state temperature sensor and microprocessor-based digital circuitry. The standard sensing range is -40°F to 199°F or -40°C to 93°C switchable. The system can execute an emergency shutdown function with an optional electrically actuated valve installed. The alarm can be silenced at any time by pressing the reset button. When the temperature is normal, the system can be reset. The module can be panel-mounted, or installed in a standard 4" x 4" electrical wall box.

Applications

The Series LF460 AquaSentry2® Alarm System is ideal for monitoring domestic and institutional hot water systems. Typical commercial applications include hot water heaters, boilers, sitz baths, shower rooms and therapeutic services. Typical commercial applications include process heat exchangers, storage tanks, chillers and lube oil coolers. The standard alarm package may be used to monitor off-normal temperature conditions. Alarm modules can also be coupled with a switch-closure device to monitor off-normal pressure, flow, status, humidity, and/or level.



HydroGuard® XP Series Emergency Tempering Valve with Cold Water ByPass

- Powers' Advanced Thermal Actuator provides precise temperature control
- Exclusive internal cold water bypass ensures cold water flow in the event of loss of hot water
- Flow effectively shuts down upon loss of cold water supply when tested under the condition specified in ASSE 1071 standard
- Vandal-resistant locking mechanism to secure temperature setting
- Factory tested
- Rough bronze and chrome finishes
- Checkstops to prevent cross flow



HydroGuard XP LFMM430 Supply Fixtures with Cabinets

Powers HydroGuard XP Series Lead Free* cabinet supply fixtures are fully assembled and factory tested. Each system is equipped with a LFMM430 Series thermostatic tempering valve, featuring Powers advanced paraffin actuation technology for fast response. Standard features include pressure/temperature gauge, outlet ball valve and triple-duty check stops. Optional equipment includes inlet pressure/temperature gauges, cold water by-pass and AquaSentry2 high-temperature alarm. Cabinets are available in recessed, semi-recessed and wall-mount styles. Construction includes stainless steel and powder coated steel. Tempering valves are listed to ASSE 1017 and CSA B125.



POWERS 900 Series



FIG NO
59514

Concealed, 4 port, pressure balancing mixing valve for use in shower and tub/shower applications. Uses diaphragm type pressure balancing mechanism. All internal parts made of lime resistant Celcon polymer for extended trouble free service. Integral adjustable limit stop reduces possible over adjustment of handle to restrict hot water mix. Cast brass body, chrome plated ABS face plate with color graphic insert, ergonomically designed chrome plated ABS lever type handle, and corrosion resistant material throughout ensure years of trouble free service. Cast-in integral checkstops reduce installation time. Unique construction allows for shallow wall installation - in as little as 2" (51mm). Back-to-back installation possible in only 4" without costly cross-piping.

INCLUDES: Valve, arm & flange, showerhead & threaded diverter spout!

POWERS e420 Series



The Series e420 HydroGuard T/P automatically mixes hot and cold water to deliver blended water within a specified range. Using an advanced thermal actuator, the Series e420 quickly compensates for temperature fluctuations induced by water temperature and pressure changes. In the event of cold water failure, the thermostatic motor virtually shuts off the flow of hot water. **Featuring** heavy, cast-brass construction, all parts of the e420 Series valve are accessible from the front of the valve and are corrosion resistant. The unit also features a concealed handle rotation stop to guard against overadjustment, and all Series e420 valves open in the cold water position to ensure maximum bather safety and comfort.

The accuracy, reliability and water economy of the Series e420 HydroGuard make it preferable for applications that require precise, consistent water control: showers, baths, hospital hydrotherapy and residential areas. Many HydroGuard Series e420 valves and shower systems can be selected to meet the Americans with Disabilities Act (ADA).

- E425 Thermostatic Valve 1/2" NPT 3 Port
- E426 Thermostatic Valve 1/2" NPT 4 Port



Advanced Thermal Activation

HYDROGUARD® XP Master Tempering Valves Series LFMM430

- Brass body and checkstops for durability and to comply with installation requirements.
- Valve utilizes paraffin-based advanced thermal actuation technology to sense and adjust outlet temperature
- Dirt and lime resistant poppet and seat design
- Virtual shutoff if supply pressure fails
- Vandal-resistant locking mechanism to secure temperature setting
- Factory tested • Rotatable union triple-duty checkstops
- Rough bronze and chrome finishes
- Temperature Adjustment Range: Standard 90 – 160°F (32 – 71°C)
Low 60 – 90°F (16 – 32°C) Also available



DESCRIPTION	FIG NO
431 Inlets/Outlets 3/4" / 3/4" Weight: 11.5 lbs	205952
432 Inlets/Outlets 3/4" / 1" Weight: 14.0 lbs	205953
433 Inlets/Outlets 1 1/4" / 1 1/4" Weight: 26.0 lbs	205957
434 Inlets/Outlets 1 1/4" / 1 1/2" Weight: 30.0 lbs	205958

POWERS 420 Complete Upgrade Kit

- Instant upgrade for worn valves
- Provides stronger pressure
- Includes single lever, pressure balancing cartridge, bonnet assembly, screws, O-rings, wax element, limit stops

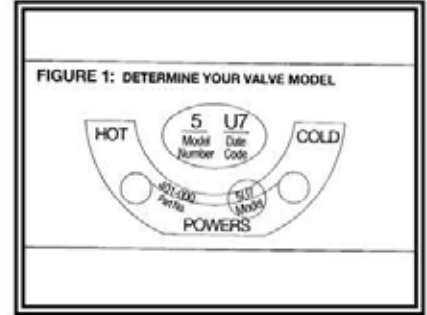
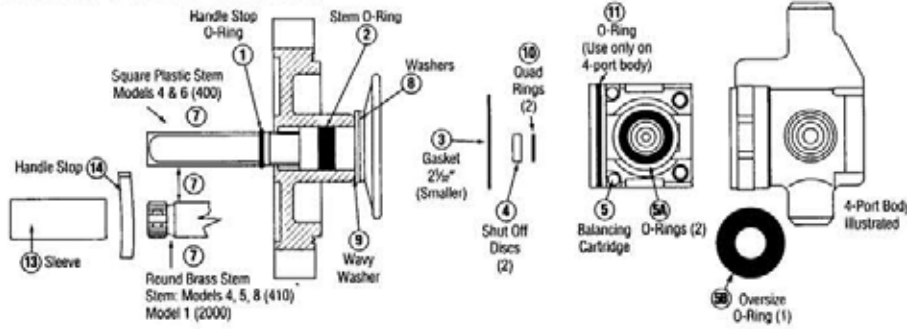

FIG NO

137827

HYDROGUARD 400/410

POWERS REPAIR PARTS



TROUBLESHOOTING	USED WHERE	FIG. NO.	REPAIR KIT INCLUDES
Cartridge slips while seated in body. Flow continues after mixer is turned off, and all other seals have been replaced.	400,410 and 2000 all models	410-570	1-4, 5a, 5b*, 10, 11 Use item 11 only in models 4-6, 4-port body (see note 1 below)
1. Water leak at stem and/or bonnet. 2. Flow continues after mixer is turned off.	Gasket and Disc Replacement	45098	1-4, 5a, 10, 11 Use in item 11 only in models 4-6 4-port body (see note 1 below)
1. Variable or untempered discharge temperature. 2. Leakage after mixer is turned off.	Balance Chamber	45095	3-5, 5a, 10, 11 Use item 11 only in models 4-6 4-port body (see note 1 below)
	400: models 4-6 410: models 4,5 2000: model 1 410: model 8	45099	3-5, 5A, 13, 15, 16
1. Flow continues after mixer is turned off. 2. Handle splines on stem damaged.	Stem and plate replacement	45096	1-4, 7-9 Item 7 has square plastic stem and plate (see note 2 below)
	400: models 4-6 410: all models 2000: all models	45100	1-4, 7-9 Item 7 has round brass stem and plastic plate

NOTE1: O-ring, item 11 is used only in 4-port mixers

NOTE2: "C" on stem must face cold water inlet. For model 4-400, you must also order new handle for new brass stem. Order either lucite handle kit #410-383 or lever handle kit #41-0384

HYDROGUARD 400 - MODELS 4 & 6
HYDROGUARD 410 - MODELS 4, 5, 8
HYDROGUARD 2000 - MODEL 1

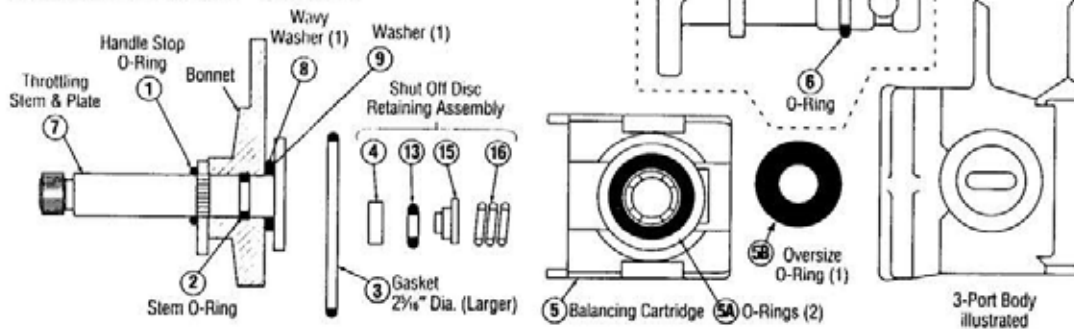

ALL PARTS AVAILABLE IN BULK!

TROUBLESHOOTING	USED WHERE	FIG. NO.	REPAIR KIT INCLUDES
1. Cartridge slips while seated in body. 2. Flow continues after mixer is turned off, and all other seals have been replaced.	400/410 All models	—	1-4, 5A, 5B*, 6
1. Water leak at stem and/or bonnet. 2. Flow continues after mixer is turned off.	Gasket and Disc Replacement	45098	1-4, 5A, 6
1. Variable or untempered discharge temperature. 2. Leakage after mixer is turned off.	Balance Chamber	45099	3-5, 5A, 13, 15, 16
	400: models 1-3 410: models 1-3, 7 Metal and Plastic Bonnet		
1. Flow continues after mixer is turned off. 2. Handle splines on stem damaged.	Stem and plate replacement	45100	1-4, 7-9 1-4, 7-9 1-4, 7-9 (shorter stem)
	400: models 1-3 410: all models 419's Only	410-378A	

*Use O-ring only on Hydroguard 412/414. Others use gasket. **Item 7 has brass stem and Calcon Plastic Mixing Plate

***When using oversized O-ring (item 5B), discard one of the two regular sized O-rings (5A) normally used and use item 5B in its place.

POWERS REPAIR KITS

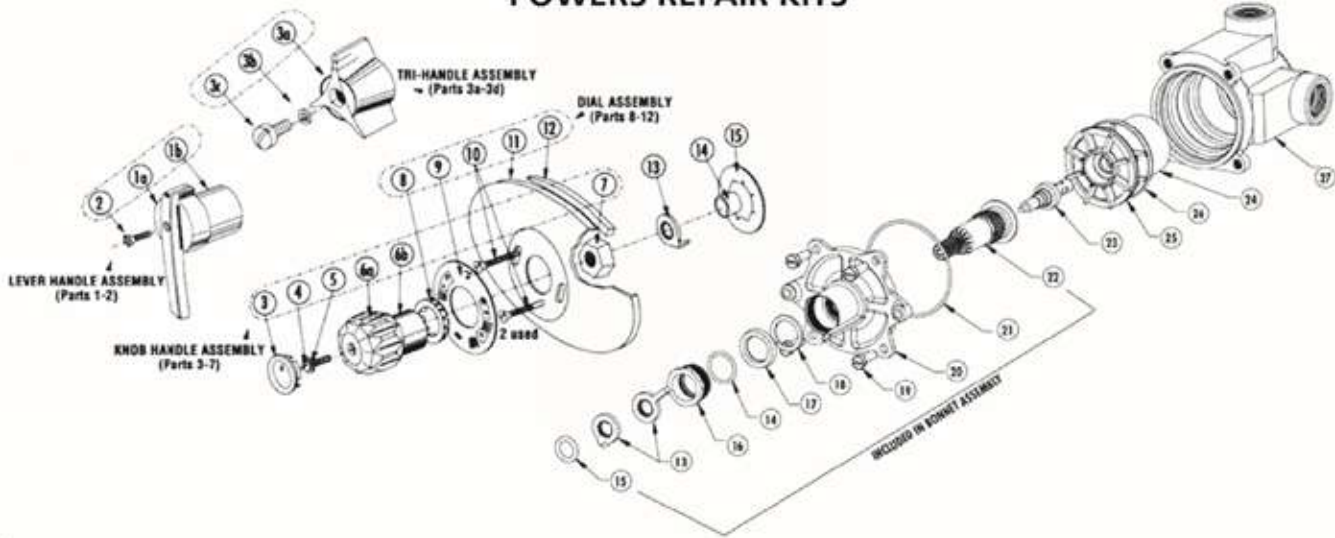

Item	Part Description	Qty.	Kit #	Qty.	Individual Parts Material
1-2	Lever Handle Assembly (Models 8 & 9)		420-336	1	
1a	Lever Handle --		420-336	1	C.P. Zinc
1b	Sleeve	--	420-336	1	C.P. Brass
2	Lever Handle Screw	10		1	C.P. Brass
3a-3d	Tri-Handle Assembly (All Models 1-9)		410-565	1	
3a	Tri-Handle	1	410-565	1	C.P. Brass
3b	Washer	1	410-565	1	C.R. Steel
3c	Screw	1	410-565	1	Stainless Steel
3d	Plug Button (NS)	1	410-565	1	
3-7	Acrylic Handle Assembly		420-337	1	
3	Plug Button and Insert	1	420-337	1	C.P. Brass
4	Handle Screw 8-32 x 3/4"	1	420-337	1	C.P. Brass
5	Washer	1	420-337	1	Neoprene
6a	Acrylic Handle Knob	--	420-337	1	Acrylic
6b	Sleeve	1	420-337	1	Brass
7	Knob Insert	2	420-337	1	
8-12	Dial Assembly (Models 8 & 9)		420-335	1	
8	Retaining Ring 227-166	1	420-335	1	C.P. Brass
9	Dial Graphic Insert (F")	1	420-335	1	Aluminum
10	Dial Plate Screws: (Concealed) 8-32 x 1-1/2" (2)	2	420-335	1	Brass
11	Dial Plate (Oval) 420-166	1	420-335	1	Stainless Steel
12	Dial Gasket	1	420-335	1	Buna-N

Item	Part Description	Qty.	Kit #	Qty.	Individual Parts Material
13	Temp. Stop	2	420-451	--	Stainless Steel
14	O Ring	1	420-451	--	Buna-N
15	O Ring	1	420-451	--	Buna-N
16	Packing Gland 420-578	1	420-451	--	Brass
17	Hava Cup	1	420-451	--	Buna-N
18	Packing Stop Ring	1	420-451	--	Brass
19	Bonnet Screws 030-887	4	420-451	--	Stainless Steel
20	Bonnet	1	420-451	--	Brass
21	O Ring	1	420-451	--	Buna-N
22	Adjustment Stem	1	420-451	--	Brass
23	Thermal Actuator	1	420-451/453-	--	Brass/Stainless Steel/EPPM
24	Cartridge Assembly	1	420-451/452-	--	Noryl/Stainless Steel
25	O Ring	1	420-451	--	Buna-N
26	O Ring	1	420-451	--	Buna-N
27	Valve Body	1	N/A	--	Brass
	(Part of 22) Shutoff Disc 420-130	1	420-451	--	EPPM
	Bonnet Stem Assembly	--	420-454	--	
	Soft Part Kit	--	420-102	--	

-- Item not available as individual commercial part OR item not available as a commercial kit.



REPAIR / INSTALLATION INSTRUCTIONS — HYDROGUARD ACCESSORIES

REPAIR PARTS

ITEM	141-176	141-177	141-187	141-326	DESCR
1	230-295	-	230-296	230-296	Vlv Body
2	445-134	445-135	445-134	445-134	Adj Stem
4	445-136	115-137	445-136	445-136	Bonnet

To replace internal parts, use repair kit 48501 (includes items 3,5,6,7,8 and 9)

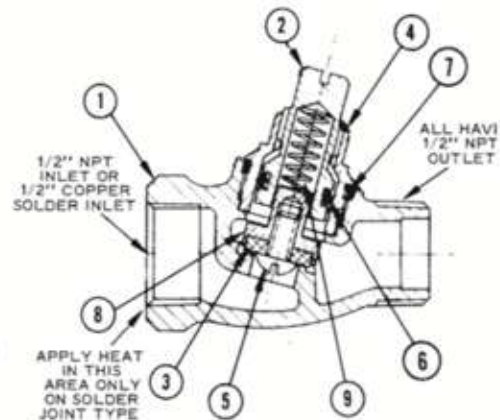

If you don't see it, contact your DUFF representative at info@duffco.com

POWERS REPAIR KITS

Parts List - LFMM431, LFMM432, LFMM433, LFMM434 ■

Index	Description				
		LFMM431	LFMM432	LFMM433	LFMM434
1	Checkstop Rebuild Kit	LF390 800	LF390 800	LF390 801	LF390 801
2	Plunger Kit	390 802	390 802	390 803	390 803
3	Adjusting Screw	390 688	390 688	390 688	390 688
4	O-Ring	390 805	390 805	390 806	390 806
5	Actuator - Standard Temperature	390 807	390 807	390 809	390 809
6	Actuator - Low Temperature	390 808	390 808	390 810	390 810
7	Funnel Kit	390 826	390 826	390 827	390 827
8	Locknut	1051117	1051117	1051117	1051117

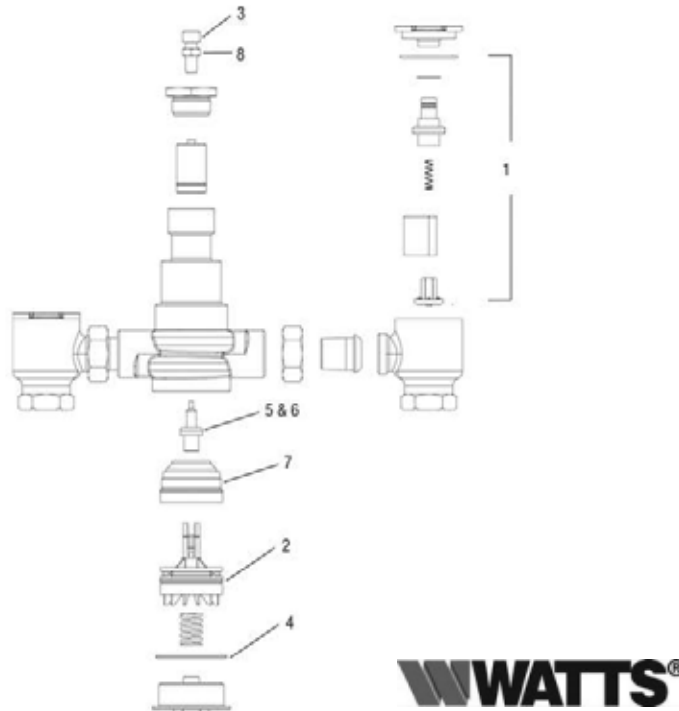

Parts List - LFMM435 ■

Index	Description	
		LFMM435
1	Checkstop Rebuild Kit	LF390 811
2	Plunger Kit	390 812
3	O-Ring	390 813
4	Actuator - Standard Temperature	390 814
5	Actuator - Low Temperature	390 815
6	Funnel Kit	390 828
7	Adjusting Screw	390 688
8	Locknut	1051117

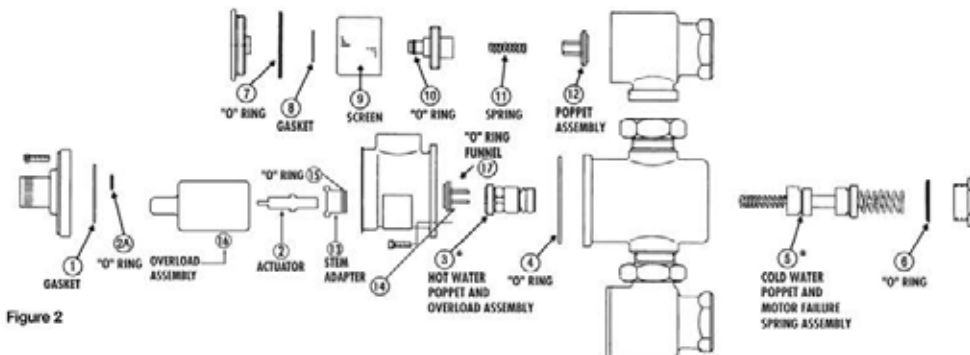
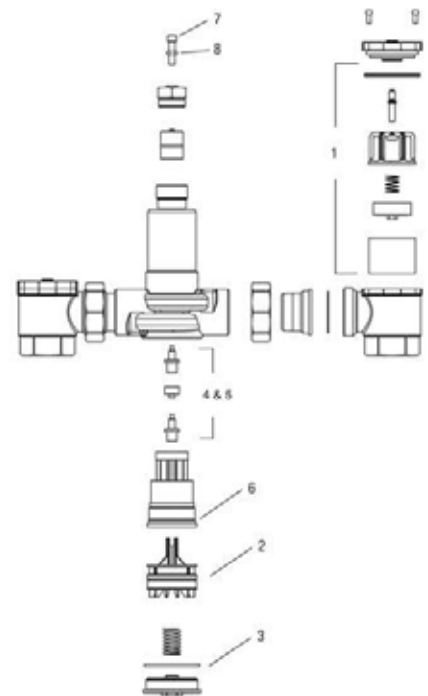

Figure 2

PART DESCRIPTION	REPAIR KIT INCLUDES: (Numbers below correspond with numbers in Figure 2)	431 Part No.	432 Part No.	433 Part No.	434 Part No.
Thermal Actuator	1, 2, 4, 13, 15	390-037	390-036	390-065	390-066
Strainer Replacement	7, 8, 9, and 10	230-134	230-134	230-136	230-136
Checkstop Replacement	7, 8, 10, 11, and 12	230-135	230-135	230-137	230-137
Gasket and Disc Replacement	1, 2A, 4, 6, 7, 8, 10, and 12	390-294	390-298	390-302	390-306
Mixing Valve Replacement	3, 4, 5, and 6	390-067	390-068	390-069	390-070
Upgrade Kits for Older Valves**	1, 2, 2A, 4, 13, 14, 15, 16, 17	390-016	390-017	390-511	390-512

Strainer and Checkstop Repair Kits contain parts for one (1) pair.

Repair Kits containing "O" Rings include silicone gel for use on "O" Rings during installation.

** For valves shipped prior to 1-1-2001.

POWERS 800/900 SERIES REPAIR KITS

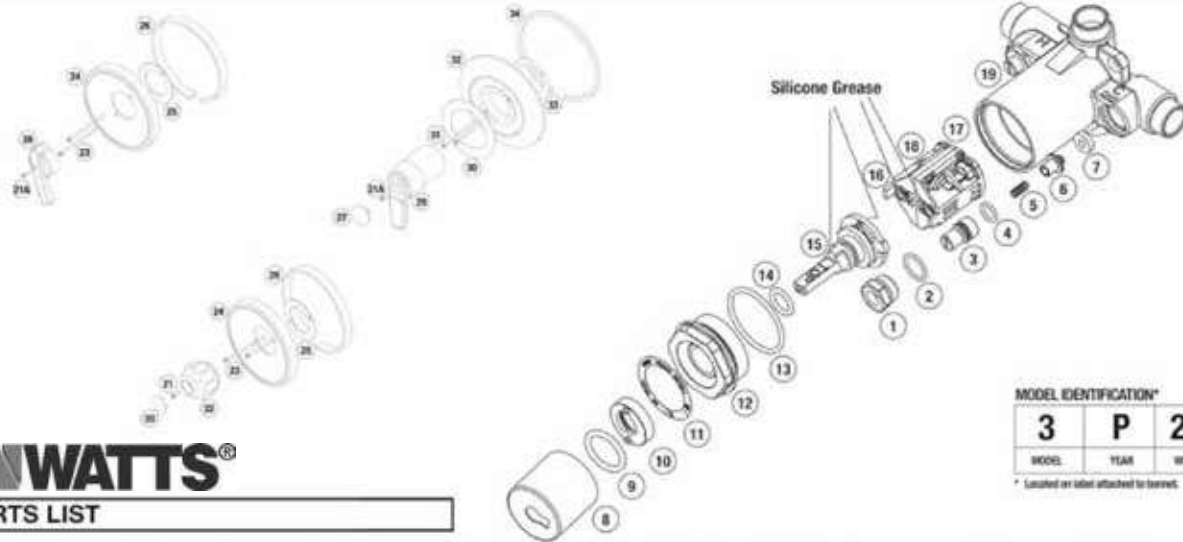

PARTS LIST

Item	Part No.	Description	Material	Kit No.***	Item	Part No.	Description	Material	Kit No.***
1	900 213	Bonnet Nut	Brass	900 050	19		Body	Bronze	N/A
2	084 029	O-Ring	Buna-N	900 028, 050	20	900 140	Plug Button	Acrylic	900 035
3	900 214	Check Stem	Brass	900 050		900 142	Insert		900 035
4	084 030	O-Ring	Buna-N	900 025, 050	21	800 161	Screw 8-32 x 5/8"	Brass	900 035
5	900 215	Spring	S.S.	900 050	21A	800 164	Screw 8-32 x 5/8"	Brass	900 105, 036
6	900 212	Poppet	Brass	900 050	22	900019C	Knob	Acrylic	900 035
7	800 061	Disc	Buna-N	900 028, 050	23	080 026	Screw 8-32 x 3 1/2"	Brass	900 040, 102
8*	800015H	Sleeve	C.P. Brass	900 269	24	900020A	Round Dial Plate	S.S.	900 040
9	084 041	O-Ring	Buna-N	900 028	25	800 020	Gasket	Buna-N	900 040
10	900 220	Limit Stop	Celcon	900 032	26	401 229	Gasket	Buna-N	900 040
11	900 137	Name Plate		900 032	27	900 096	Plug Button	ABS	900 105
12	900 219	Bonnet		900 032	28	900 070	Lever Handle	Cast	900 036
13	084 032	O-Ring	Buna-N	900 028, 032	29	900 091	Handle	ABS	900 105
14	084 033	O-Ring	Buna-N	900 028, 032	30	900 095	Insert	Mylar	900 102
15	900 231	Stem Assy.		900 032	31	080 026	Screw 8-32 x 3 1/2"	Brass	900 040, 102
16	900 197	Outlet Seal		900 028, 032	32	900 090	Trim Plate	C.P. ABS	900 102
17	084 031	O-Ring	Buna-N	900 028, 032	33	900 093	Sleeve Gasket		900 102
18	900 240	Cartridge	Celcon	900 032	34	900 094	Trim Gasket		900 102
19	902 234	Retainer (not shown)	Brass	N/A					

* 900 132 in Model P910. ** Plug button (#900 140), insert (#900 142), and lucite handle (#900 019) are included in Lucite Handle Assembly Kit #900 035.

***Parts must be ordered by Kit number, not by individual part number. N/A = Part not available.

TROUBLESHOOTING & REPAIR KITS

Description	Troubleshooting	Repair Kit No.
Gasket and Disc Replacement (mixer & checkstops)	<ul style="list-style-type: none"> Water leaks at valve stem and/or bonnet. Water leaks at valve shut-off. Water leaks at checkstop. 	900 030 Models 1 & 2* 900 028 Model 3
Internals Replacement	<ul style="list-style-type: none"> With mixer handle in MID position, hot water flows with cold water checkstop closed or cold water flows with hot water checkstop closed. 	900031A Model 1 900 031 Model 2 900 032 Model 3
Checkstop Replacement	<ul style="list-style-type: none"> Checkstop will not completely shut off. 	900 049 Models 1 & 2 900 050 Model 3
Conversion from 800 Lever Handle to 900 Lever Handle	<ul style="list-style-type: none"> 800 handle will not operate properly. 	800 098**

Model 1—Use white TFE gasket, Model 2—Use black Viton A O-ring. ** Replacement of Biltmore 800 handle/stem, escutcheon, or cartridge upgrades the valve to a Biltmore 900 Model 2.

TROUBLESHOOTING & REPAIR KITS

Description	Troubleshooting	Repair Kit No.
Conversion from 800 Lucite Knob to 900 Lucite Knob	<ul style="list-style-type: none"> 800 handle will not operate properly. 	800 099**

ADDITIONAL KITS

ABS Lever Handle Kit (Model 905)	900 105
Faceplate Assembly (Model 905) (chrome finish)	900 102
Faceplate Assembly, Round	900 040
Plug Button with Insert for Lucite Handle	900 140
Plug Button Bulk Pack (25 pieces of 900 140)	900140BP
Stem Extension Kit	900 109
Thin Wall Mounting Kit	900 119
Vandal-Proof Screws (for handle and faceplate)	900 034



REPAIR KITS

Type TM-25

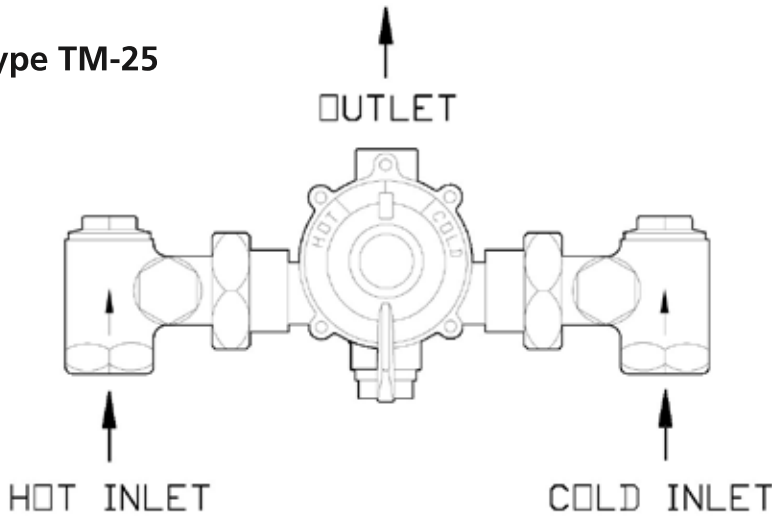

KIT 1/25 PACKINGS & GASKETS

- M20-4C GLAND PKG. (2 EACH)
- TM-011 CHECK SPRING (2 EACH)
- M20-3C COVER GASKET
- TM-25-6B HOLDER NUT O-RING (2 EACH)
- TM-013 SCREEN (2 EACH)
- TM-08 O-RING (2 EACH)
- TM-05 BONNET PKG. (2 EACH)
- TM-014 CAP PACKING (2 EACH)
- TM-03 LOWER STEM & PKG. (2 EACH)

KIT R/25 REBUILDING KIT

- M20-3C COVER GASKET
- TM-25-1-12B THERMOSTATIC CONTROL ASSEMBLY

KIT 2/25 REBUILDING KIT

- 2 EACH
- TM-03 LOWER STEM & PACKING
- TM-08 UPPER STEM O-RING
- TM-013 SCREEN
- TM-05 BONNET PKG.
- TM-011 SPRING
- TM-014 CAP PACKING

Thermostatic Water Mixing Valves
Type TM-30, 50, 125, 150

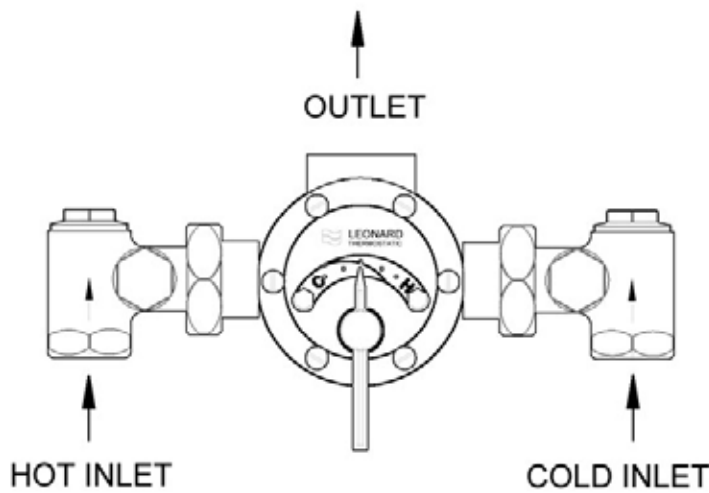

REPAIR KITS

KIT 1/___ PACKING & GASKET KITS

KIT 1/50 FOR TM-30, TM-50, OR TM-80
KIT 1/125 FOR TM-125 OR TM-150
2 each **

- 011 SPRING **
- 013 SCREEN **
- 05 BONNET PKG. **
- 03 LOWER STEM & PACKING **
- TM-21/ FLANGE PKG.
- MU-5A UPPER STEM O-RING (4 REQD.)
- 014 CAP PACKING **

KIT R/___ REBUILDING KITS

R/TM30 FOR TM-30
R/50 FOR TM-50 OR TM-80
R/125 FOR TM-125 OR TM-150

- PORT SLEEVE NUT ASSY.
- POINTER ROD O-RING (2 REQD.)
- FLANGE PKG.
- COIL SLEEVE STUD
- PORT SLEEVE ASSY.
- THERMOSTAT GROUP

KIT 2/50 CHECKSTOP KITS (ALL VALVES)

2 each

- MU-5A UPPER STEM O-RING
- 013 SCREEN
- 05 BONNET PKG.
- 03 LOWER STEM & PACKING
- 011 SPRING
- 014 CAP PACKING



Keep repair kits on hand for emergencies.
Find out more at www.duffco.com

SYMMONS PARTS

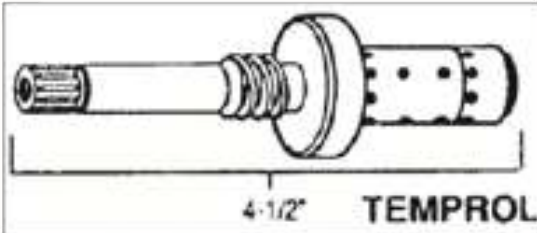

4-1/2" **TEMPROL**
Temprol spindle assembly TA-10

FIG. NO.	PRICE
58521	



Washer/gasket repair kit B for Symmons Safety Mix spindle

FIG. NO.	PRICE
58522	



Hot and cold seat repair kit TA-4 for Symmons Temprol spindle

FIG. NO.	PRICE
53968	

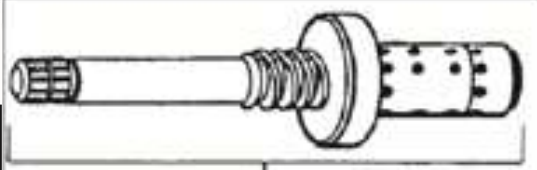

5-1/4" **SAFETY MIX**
Symmons Safety Mix spindle assembly C5

FIG. NO.	PRICE
47675	



Symmon BT9 repair kit for TA-10 and C-5



Washer repair kit TA-9 for Symmons Temprol spindle

FIG. NO.	PRICE
58524	

ALL SYMMONS PARTS AVAILABLE IN BULK!

Symmons Tempering Valves Adjusts Temperature

To supply tempered water to a single faucet. 3/8" compression connection. Adjustable temperature, chrome finish.

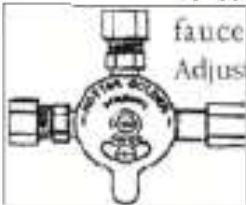
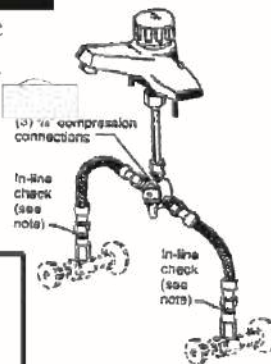

FIG. NO.	PRICE
60452	

Symmons Metering Faucet Typical



Symmons 3 piece repair kit to renew seat.

DUFF TIP: Don't forget to order your supply stops and faucet connectors!

To supply tempered water to the hot inlet of a two supply faucet.

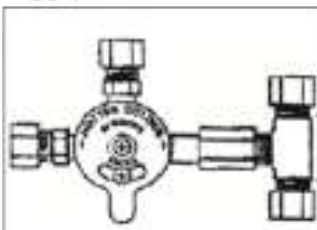
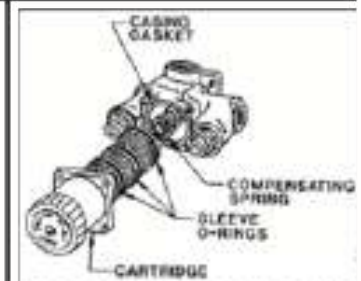
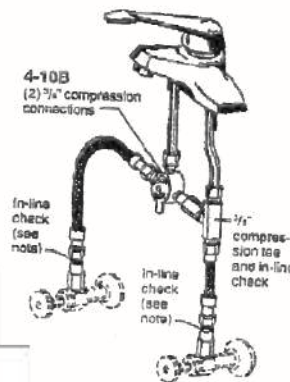

FIG. NO.	PRICE
60453	

Symmons Single Lever Faucet Typical



CARTRIDGE UNITS AVAILABLE

FOR

5-200C, 5-400C, 5-500C,
5-700C, 5-900C, 5-1000C

DUFF TIP: Don't forget to order your supply stops and faucet connectors!

MOEN FAUCETS



Go to duffco.com for all the latest featured products.

Call or email us at info@duffco.com for special pricing.



MOEN 6120 Kingsley
two handle lavatory faucet

- Metal construction with various finishes
- 1/2" IPS connections
- Includes metal pop-up waste assembly
- Lever style handles
- 1224 Cartridge design

FIG NO	FINISH
222554	CHROME
216170	BRUSHED NICKEL

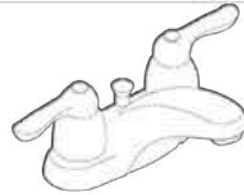

MOEN 4925 Chateau
two handle lavatory faucet

- Metal construction with various finishes
- 1/2" IPS connections
- Includes metal pop-up waste assembly
- 1224 Cartridge design

FIG NO	FINISH
250599	



MOEN 6410 EVA
two handle lavatory faucet

- Metal construction with various finishes
- 1/2" IPS connections
- Includes metal pop-up waste assembly
- 1224 Cartridge design

FIG NO	FINISH
234567	BRUSHED NICKEL
269309	OIL-RUBBED BRONZE

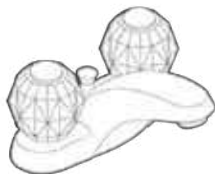

MOEN 4920/4900 Chateau
Two handle lavatory faucet

- Metal construction with various finishes
- 1/2" IPS connections
- Knob style handles
- 1224 Cartridge design

FIG NO	MODEL	PACKAGE
41864	4920	with Pop-Up
211641	4925	less Pop-Up

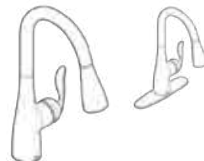

MOEN 7594 Arbor
Single handle high arc pulldown kitchen faucet

- Offers smooth operation, easy movement and secure docking
- Metal construction with various finishes
- Pullout spray w/ 68" braided hose
- Flexible supply lines with 3/8" compression fittings
- 1255™ Duralast™ cartridge
- Sold with deck plate

FIG NO	FINISH
244440	Classic Stainless Steel



MOEN 67315 Integra
Kitchen faucet

- Metal construction with various finishes
- Pullout spray w/ 59" braided hose
- Flexible supplies with 3/8" compression fittings
- 1255™ Duralast™ cartridge
- Sold with deck plate

FIG NO	FINISH
255962	Spotless stainless steel
193487	Chrome



MOEN 4903
Two handle bar faucet

- Metal construction with various finishes
- 1/2" IPS fittings
- 1224 Cartridge design

FIG NO	FINISH
233197	



MOEN L4621/L4601 Chateau
Two handle lavatory faucet

- Metal construction with various finishes
- 1/2" IPS connections
- Includes pop-up waste assembly
- Pivot action lever style handle
- 1224 Cartridge design

FIG NO	MODEL	PACKAGE
54317	L4621	with Pop-Up
108989	L4601	less Pop-Up



MOEN 4621/4601 Chateau
Single handle lavatory faucet

- Metal construction with various finishes
- 1/2" IPS connections
- Includes pop-up waste assembly
- Acrylic knob style handle
- 1255™ Duralast™ cartridge

FIG NO	MODEL	PACKAGE
41863	4621	with Pop-Up
210824	4601	less Pop-Up



MOEN 7425 Chateau
single handle kitchen faucet

FIG NO: 82123

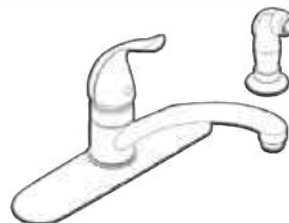

MOEN 7430 Chateau
single handle kitchen faucet with spray

FIG NO: 82122



MOEN 7560 Extensa
single control kitchen faucet

- Metal construction with various finishes
- Pullout spray w/ 59" braided hose
- Flexible supplies with 3/8" compression fittings
- 1255™ Duralast™ cartridge

FIG NO	FINISH
47603	WHITE
50786	CHROME

7430 (Old Style)

MOEN FAUCETS

7430 (New Style)

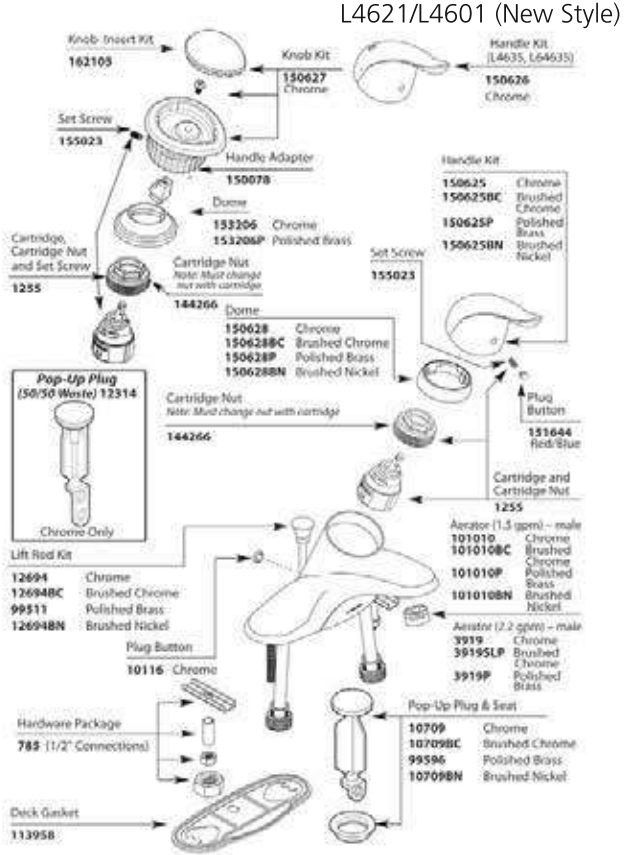
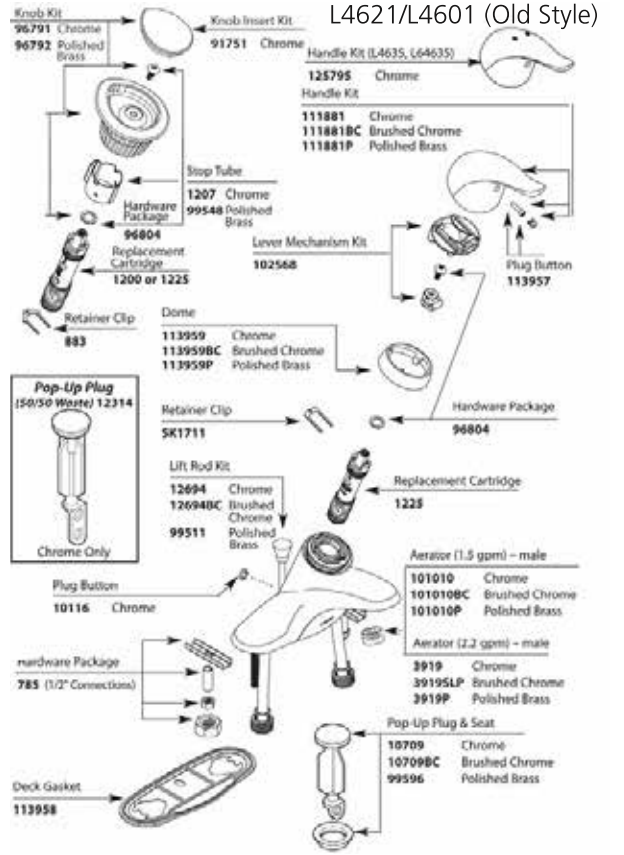
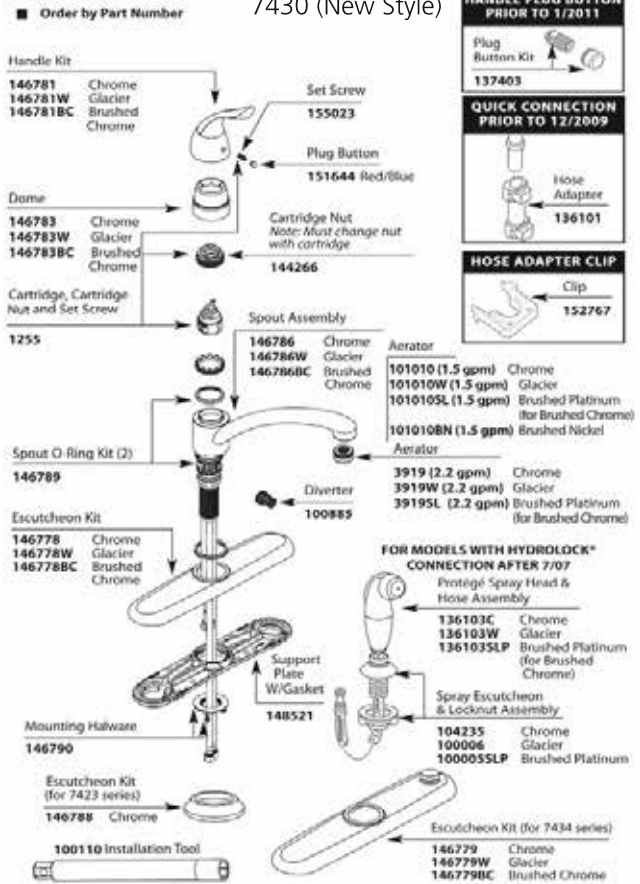
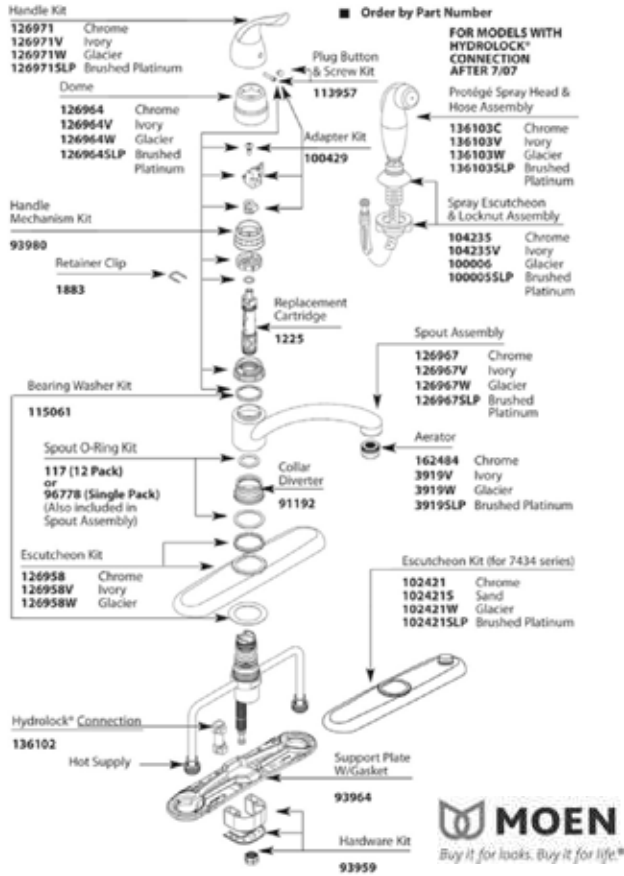

MOEN FAUCETS



Buy it for looks. Buy it for life.®

Order by Part Number

There is more than 1 version of this model. Page down to identify the version you have.

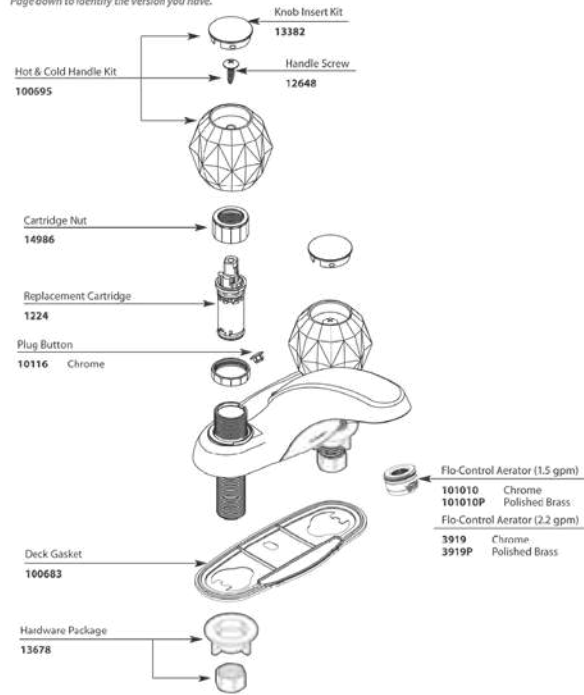

Buy it for looks. Buy it for life.®

Order by Part Number

There is more than 1 version of this model. Page down to identify the version you have.

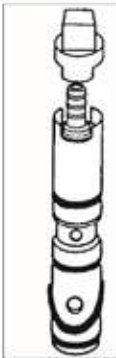
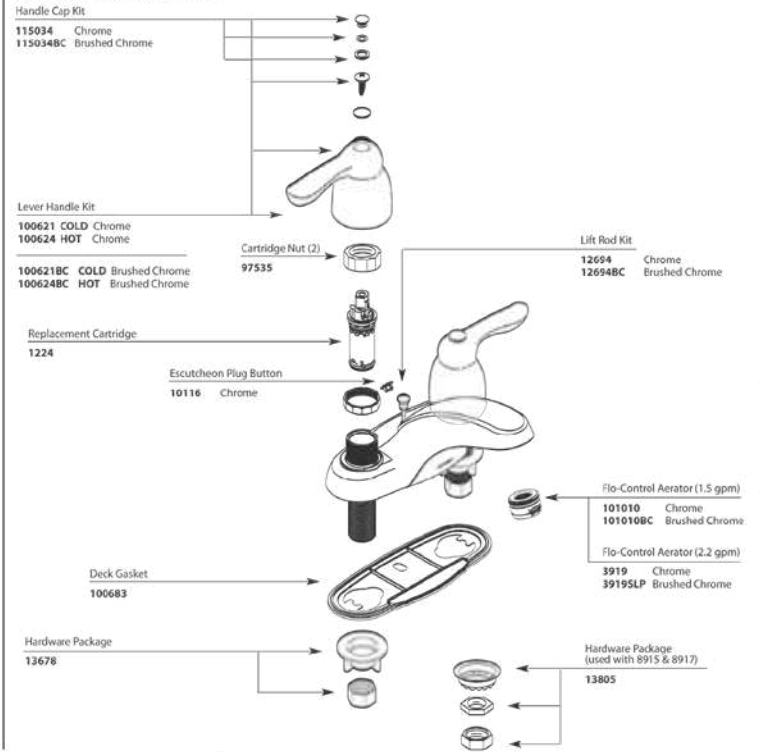

MOEN 1200 Cartridge

FIG NO
15117



MOEN 1225 Magnum Cartridge

FIG NO
39286

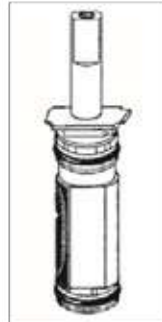

MOEN Posi-Temp 1222 Cartridge

FIG NO
47116

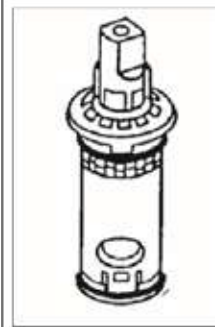

MOEN 1224 Stem for two handle faucet

FIG NO
38360



MOEN Balance Spool

FIG NO
41882

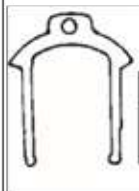

MOEN 1200-1225 Shower Clip

FIG NO	MOEN #
41876	883 1200-1225
171961	96914 1222



MOEN 1222 Kitchen Clip

FIG NO	MOEN #
41884	1883 1200-1225

Cartridge Removal Tool for 1200/1225/1222 Cartridges



OEM
124461



GENERIC
17477



Buy it for looks. Buy it for life.®

MOEN SHOWER VALVES



MOEN L2352 Chateau Posi-Temp Single Handle Shower Valve

- Chrome plated metal construction
- Pressure balancing with an adjustable temperature limit stop
- 1/2" CC connections
- Includes showerhead, arm and flange
- Lever style handle
- 1222 Cartridge design

FIG NO
167739



MOEN 2352 Chateau Posi-Temp Single Handle Shower Valve

- Chrome plated metal construction
- Pressure balancing with an adjustable temperature limit stop
- 1/2" CC connections
- Includes showerhead, arm and flange
- Clear acrylic knob style handle
- 1222 Cartridge design

FIG NO
71338



MOEN L2353 Chateau Posi-Temp Single Handle Tub/Shower Valve

- Chrome plated metal construction
- Pressure balancing with an adjustable temperature limit stop
- 1/2" CC connections
- Includes showerhead, arm, flange and diverter tub spout
- Lever style handle
- 1222 Cartridge design

FIG NO
160223



MOEN 2353 Chateau Posi-Temp Single Handle Tub/Shower Valve

- Chrome plated metal construction
- Pressure balancing with an adjustable temperature limit stop
- 1/2" CC connections
- Includes showerhead, arm, flange and diverter tub spout
- Clear acrylic knob style handle
- 1222 Cartridge design

FIG NO
71339

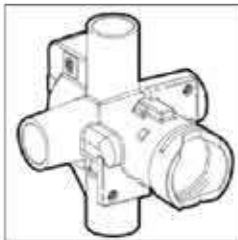

MOEN 62320 Posi-Temp Pressure Balancing Valve

- Brass construction
- 1/2" CC or IPS connections
- Pressure balancing, four port, cycle valve
- Adjustable temperature limit stop
- 1222 Cartridge design

FIG NO
147119

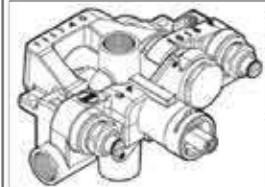

MOENTROL® Pressure Balancing Valve

- Brass construction
- Pressure balancing, four port valve with integral check stops, 1/2" CC
- 1225 Cartridge design

FIG NO
233043



MOEN 3669EP 4-Function Massaging Handshower w/Slide bar

- Handheld shower
- 69" double interlock spiral hose (metal)
- 30" slide bar with push button height selection
- 4-function: massage, vigorous, full and combination
- Chrome finish (Other finishes available)

FIG NO
168433

EASY CLEAN® XL 6300 Series

- (Showerhead only)
- Various finishes
 - Nonmetallic spray face
 - Nonmetallic shell
 - Single spray
 - Showerhead is limited to 2.5 gpm
 - EP suffix models are limited to 1.75 gpm
 - EP15 suffix models are limited to 1.5 gpm



FIG NO	FINISH	GPM
249923	CHROME	1.75
308046	BRUSHED CHROME	2.5

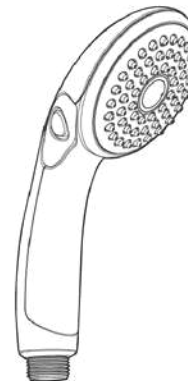

MOEN 8349 Single Function Handheld Shower

- Handheld shower
- High impact chrome plated plastic
- Quick cleaning rubber nozzles
- Single-function spray pattern
- Designed to deliver 1.5 gpm

FIG NO
219439

See page 244 for more handheld shower parts



MOEN SHOWER VALVES

POSI-TEMP

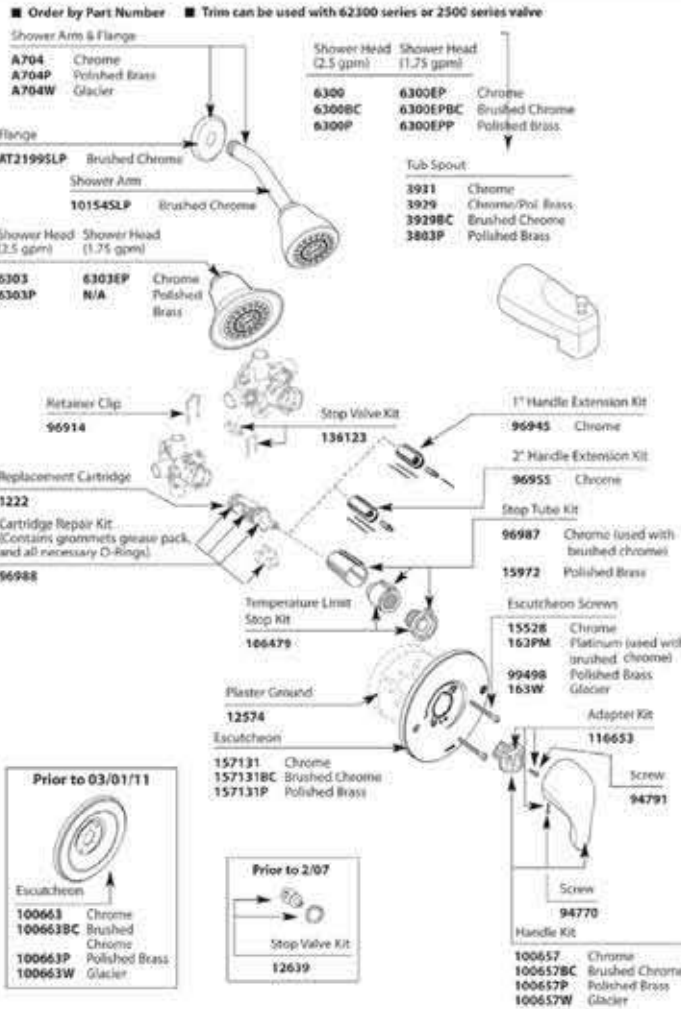

MOENTROL

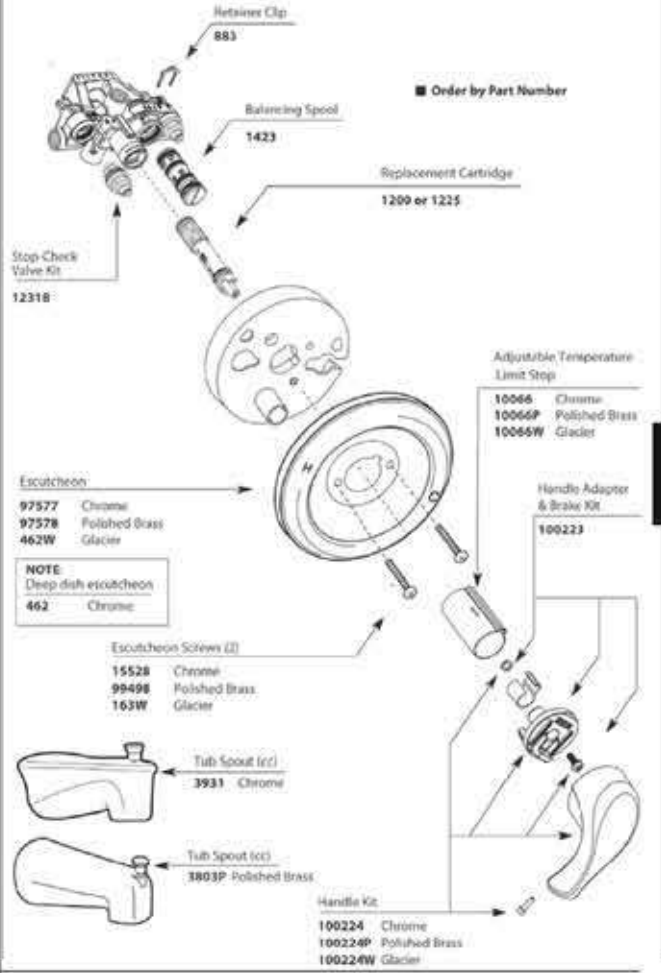

POSI-TEMP

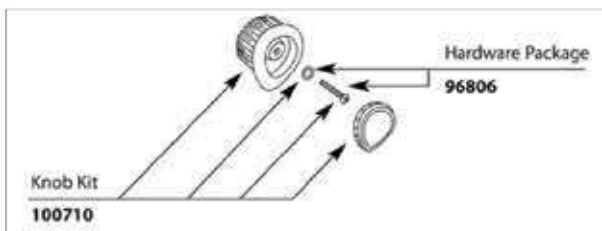

MOENTROL

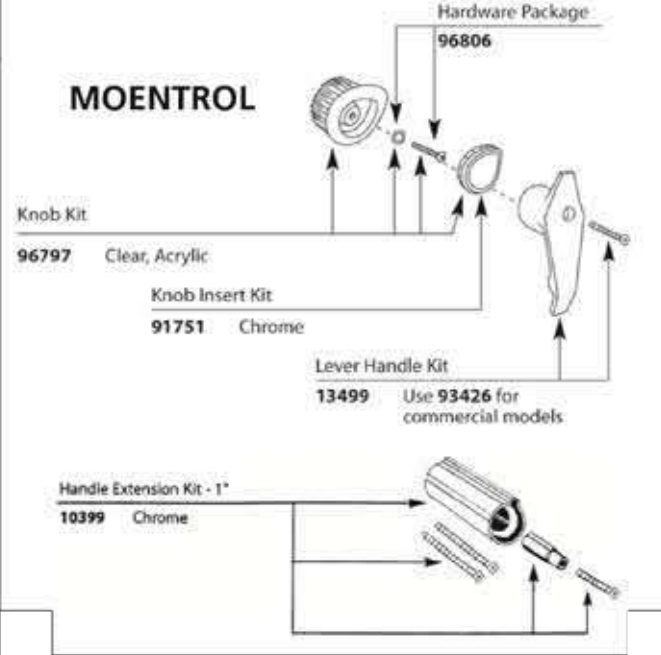

DUFF TIP:
 Don't forget
 Heat-proof Grease (51486)
 or Silicone Lubricant (23542)!

MOEN COMMERCIAL M-DURA
Electronic Sensor and Manual Flush Valves

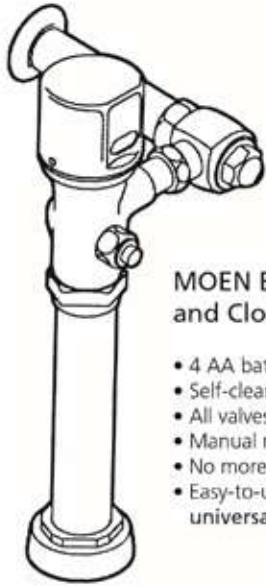

MOEN Battery Powered Urinal and Closet Flush Valves

- 4 AA batteries included
- Self-cleaning piston
- All valves allow for adjustable gpf (.125-3.5)
- Manual mechanical override button
- No more diaphragm kits!
- Easy-to-use dip switches make this a universal flush valve!

MODEL NO.	TYPE	GPF	TAILPIECE
8310	CLOSET	1.6	1-1/2"
8311	CLOSET	1.28	1-1/2"
8310DF16	DUAL	1.0/1.6	1-1/2"
8312	URINAL	1.0	3/4"
8315	URINAL	0.5	3/4"
8316	URINAL	0.125	3/4"
8314	URINAL	1.0	1-1/4"



MOEN Battery Powered Urinal and Closet Retrofit Kit

- Made to fit other manufacturers' installations
- All valves allow for adjustable gpf (.125-3.5)

MODEL NO.	TYPE	GPF
8310R16	CLOSET	1.6
8310RDF16	DUAL	1.0/1.6
8312R10	URINAL	1.0



Buy it for looks. Buy it for life.®

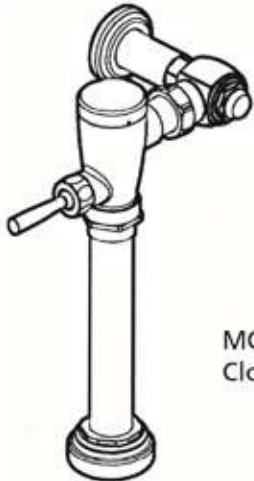

MOEN Manual Urinal and Closet Flush Valves

MODEL NO.	TYPE	GPF	TAILPIECE
8310M35	CLOSET	3.5	1-1/2"
8311M16	CLOSET	1.6	1-1/2"
8310M128	CLOSET	1.128	1-1/2"
8310M10	URINAL	1.0	3/4"
8312M05	URINAL	0.5	3/4"
8312M0125	URINAL	0.125	3/4"
8314M10	URINAL	1.0	1-1/4"



MOEN Manual Urinal and Closet Retrofit Kit

- Made to fit other manufacturers' installations
- All valves allow for adjustable gpf (.125-3.5)

MODEL NO.	TYPE	GPF
8310MR35	CLOSET	3.5
8310MR16	DUAL	1.6
8310MR128	CLOSET	1.128
8312MR10	URINAL	1.0
8312MR05	URINAL	0.5
8312MR0125	URINAL	0.125

All MOEN Commercial M-Dura Products are backed by an industry-leading 5-Year Warranty (Including Electronics!)



Order by Part Number

Illustrated Parts

Manual Exposed Style Flush Valve		
MODEL	STYLE	FLOW RATE (gpf)
8310M35	Closet	3.5
8310M16	Closet	1.6
8310M128	Closet	1.28
8313M16	Closet	1.6
8312M10	Urinal	1.0
8312M05	Urinal	0.5
8312M0125	Urinal	0.125
8314M10	Urinal	1.0
8310MR35	Closet Retrofit	3.5
8310MR16	Closet Retrofit	1.6
8310MR128	Closet Retrofit	1.28
8312MR10	Urinal Retrofit	1.0
8312MR05	Urinal Retrofit	0.5
8312MR128	Urinal Retrofit	0.125

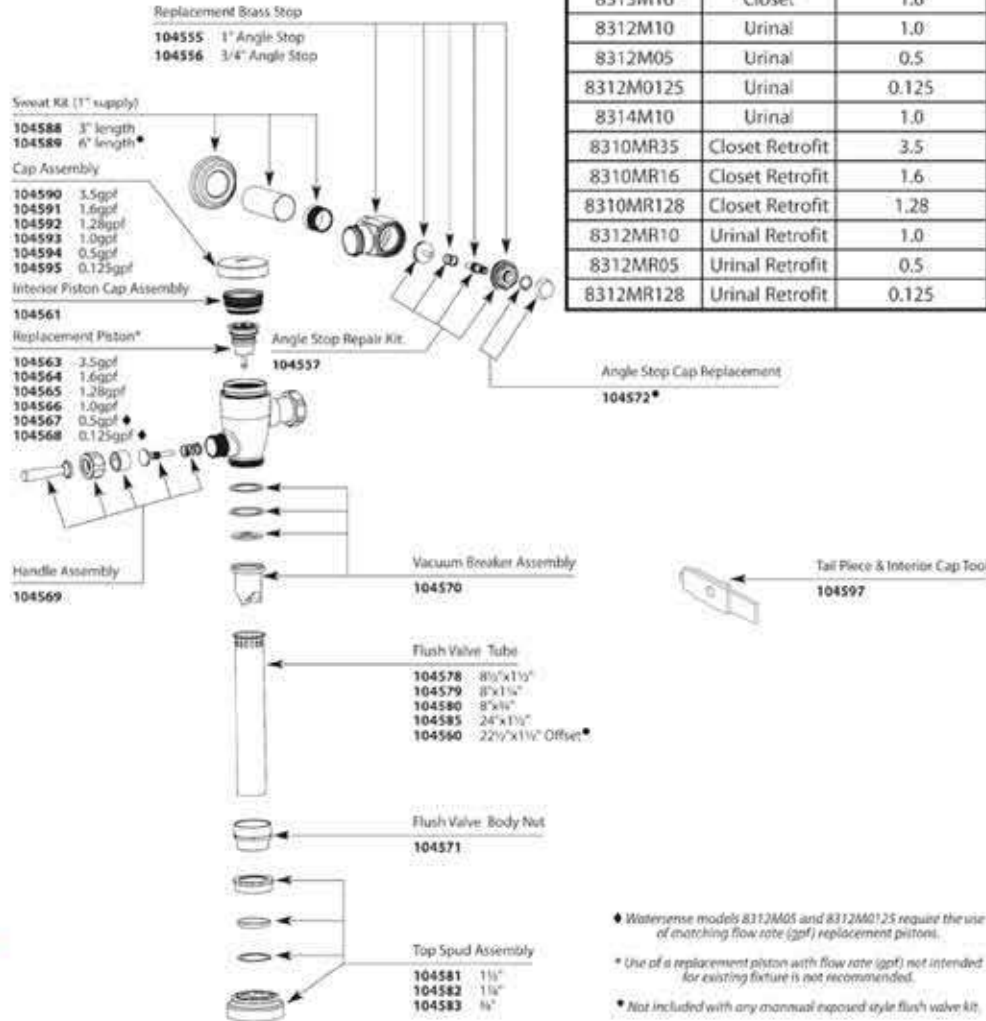

MOEN COMMERCIAL M-DURA Manual Closet Flush Valve

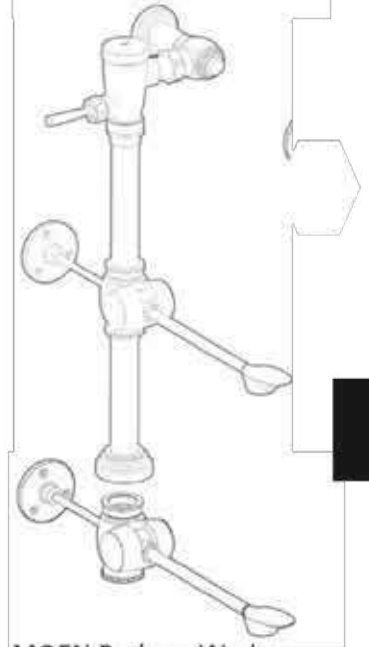

MOEN Bedpan Washer

- Manual exposed water closet flushometer with bedpan washer
- Brass angle stop valve
- Solid brass construction with chrome electroplated finish
- Solid brass spray arm
- Bearing washers and double o-ring leak prevention system
- Chloramines resistant seals
- High back pressure vacuum breaker
- Diverter valve support
- ADA compliant handle with dual o-ring seals

MODEL NO.	GPF	TAILPIPE
8310BPW35	3.5	1-1/2"
8310BPW16	1.6	1-1/2"
8312BPWR	BEDPAN WASHER DIVERTER KIT	



For additional information call: 610-275-4453 or Fax: 610-279-6299
Please call for current prices.



Illustrated Parts

■ Order by Part Number

Battery Powered Exposed Type Flush Valve		
MODEL		FINISH
8310	Closet	Chrome
8311	Closet	Chrome
8312	Urinal	Chrome
8313	Closet	Chrome
8314	Urinal	Chrome
8315	Urinal	Chrome
8310R16	Closet	Chrome
8310R35	Closet	Chrome
8312R10	Urinal	Chrome
8312R15	Urinal	Chrome

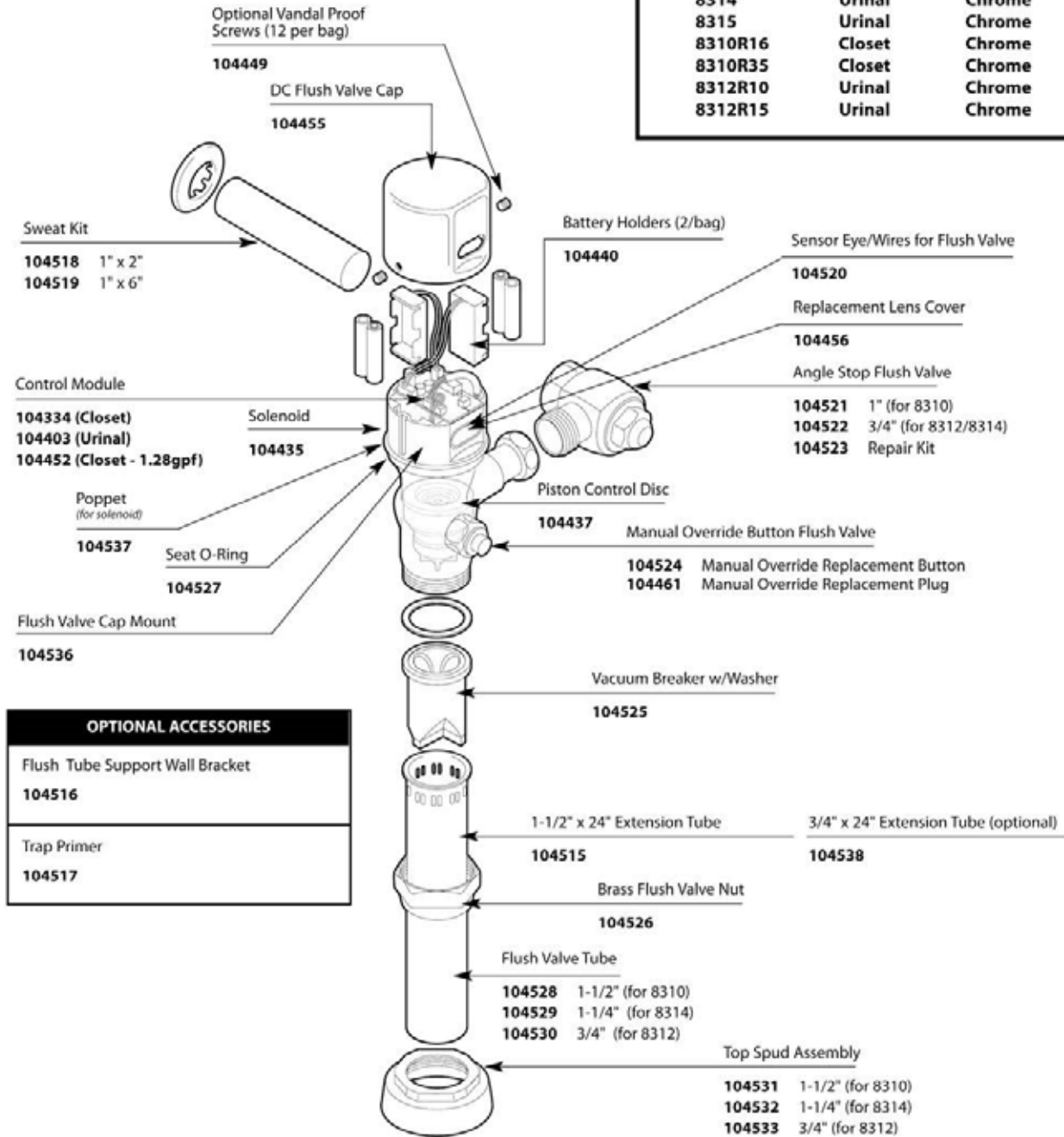

OPTIONAL ACCESSORIES
Flush Tube Support Wall Bracket 104516
Trap Primer 104517

MOEN COMMERCIAL M-DURA
Lavatory Faucets



MOEN Single Handle Lavatory Faucet

- Solid brass construction
- Chrome, Brushed Chrome or Brushed Nickel finish
- 1/2" IPS connections
- Solid brass waterways
- Lever handle
- Ceramic disc cartridge *(with temperature limit stop)
- ADA for lever handle

MODEL	FLOW(gpm)	DRAIN	FINISH	FIG NO.
8413	2.2	WITHOUT	CHROME	231583
8413F15	1.5	WITHOUT	CHROME	—
8414F05	0.5	WITHOUT	CHROME	—
8413F03	0.35	WITHOUT	CHROME	—
8414	2.2	METAL P/V	CHROME	236251
8414BC	2.2	METAL P/V	BRUSHED CHROME	—
8414BN	2.2	METAL P/V	BRUSHED NICKEL	—



MOEN Single Hole Lavatory Faucet

- Solid brass construction
- Various finishes identified by suffix
- 3/8" compression x 15" stainless steel supply lines
- Ceramic disc cartridge with temperature limit stop
- ADA for lever handle

MODEL	FLOW(gpm)	DRAIN	FINISH	FIG NO.
8417	2.2	WITHOUT	CHROME	262495
8417F15	1.5	WITHOUT	CHROME	—
8417F05	0.5	WITHOUT	CHROME	—
8417F03	0.35	WITHOUT	CHROME	—
8419	1.5	METAL	CHROME	—
8419F05	0.5	METAL	CHROME	—
8419BC	1.5	METAL	BRUSHED CHROME	—

MOEN Two Handle Lavatory Faucet

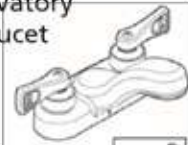

Smooth Handle



- Brass construction with chrome plated finish
- 4" centerset
- 1/2" IPS connections
- 2-1/2" lever style handles with hot and cold color indicators*
- *Smooth handle models have hot and cold color indicator at torx head screw
- Brass shell, ceramic disc cartridge
- 1/4 turn operation
- ADA for lever handle

MODEL	FLOW(gpm)	DRAIN	HANDLE STYLE	FIG NO.
8210	2.2	WITHOUT	DECAL	—
8210F15	1.5	WITHOUT	DECAL	—
8210F05	0.5	WITHOUT	DECAL	—
8210F03	0.35	WITHOUT	DECAL	—
8210SM	2.2	WITHOUT	SMOOTH	308430
8210SMF15	1.5	WITHOUT	SMOOTH	—
8216	2.2	METAL	DECAL	—
8218	2.2	GRID	DECAL	—
8208	1.5	WITHOUT, WITH CHAINSTAY	DECAL	—

MOEN Wing Handle Lavatory Faucet



Smooth Handle



- Brass construction with chrome plated finish
- 4" centerset
- 1/2" IPS connections
- 4" wrist blade handles with hot and cold color indicators*
- *Smooth handle models have hot and cold color indicator at torx head screw
- Brass shell, ceramic disc cartridge
- 1/4 turn operation
- ADA for lever handle

MODEL	FLOW(gpm)	DRAIN	HANDLE STYLE	FIG NO.
8215	2.2	WITHOUT	DECAL	177787
8215F15	1.5	WITHOUT	DECAL	—
8215F05	0.5	WITHOUT	DECAL	—
8215F03	0.35	WITHOUT	DECAL	—
8215SM	2.2	WITHOUT	SMOOTH	—
8215SMF15	1.5	WITHOUT	SMOOTH	—
8219	2.2	METAL	DECAL	—
8209	1.5	WITHOUT, WITH CHAINSTAY	DECAL	—

MOEN Two Handle Lavatory Faucet

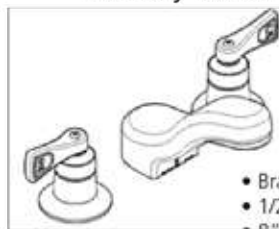

8220

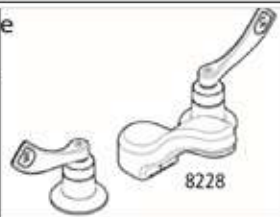

8228

- Brass construction with chrome plated finish
- 1/2" IPS connections
- 8" widespread
- Vandal resistant torx head screws
- Brass shell, ceramic disc cartridge
- 1/4 turn operation
- ADA for lever handles

MODEL	FLOW (gpm)	DRAIN	4" WING HANDLE	FIG NO.
8220	2.2	WITHOUT	NO	267456
8228	2.2	WITHOUT	YES	—
8239	2.2	WITH P/U	YES	306107

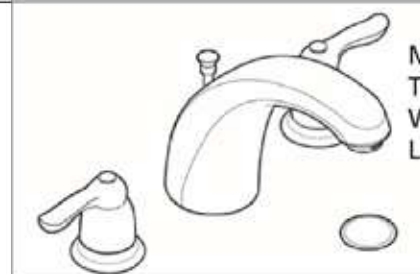

MOEN Two Handle Widespread Lavatory Faucet

- Metal construction with Chrome plated or Classic Brushed Nickel finish
- 1/2" IPS shanks
- Designed to be installed on 8" to 16" centers
- 1224 cartridge design
- ADA for lever handles

MODEL	FLOW (gpm)	DRAIN	FINISH	FIG NO.
8922	1.5	METAL	CHROME	—
8922CBN	1.5	METAL	CBN	—
8924	1.5	GRID	CHROME	313861

CBN - CLASSIC BRUSHED NICKEL

MOEN COMMERCIAL M-DURA Laundry / Kitchen Faucets

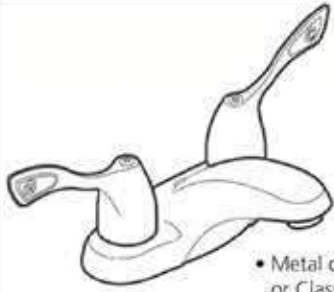

**MOEN Two Handle
Lavatory Faucet**

- Metal construction with Chrome plated or Classic Brushed Nickel finish
- Copper or brass waterways
- 1/2" IPS connections
- 4" Wrist blade style handles with hot and cold color indicators
- 1224 cartridge design
- ADA  for lever handles

MODEL	FLOW (gpm)	DRAIN	FINISH	FIG NO.
8800	1.5	WITHOUT	CHROME	—
8800CBN	1.5	WITHOUT	CBN	—
8800F05	0.5	WITHOUT	CHROME	—
8800F03	0.3	WITHOUT	CHROME	—
8810	1.5	GRID	CHROME	—
8820	1.5	METAL P/U	CHROME	232494
8820CBN	1.5	METAL P/U	CBN	—

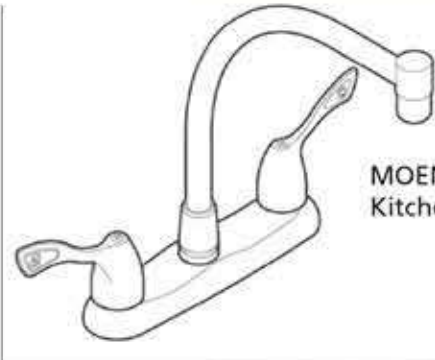

**MOEN Two Handle
Kitchen Faucet**

- Metal construction with Chrome plated finish
- 1/2" IPS connections
- 4" Wrist blade style handles with hot and cold color indicators
- 1224 cartridge design
- ADA  for lever handles

MODEL	FIG NO.
8799	238911



**MOEN Two Handle
Kitchen Faucet**

- Metal construction with Chrome plated finish
- 1/2" IPS connections
- Lever style handles with hot and cold color indicators
- Brass shell, ceramic disc cartridge
- 1/4 turn operation
- ADA  for lever handles

MODEL	FIG NO.
8287	234121

Retainer Nut & Cartridge
For 8413 and 8414 Series
231768

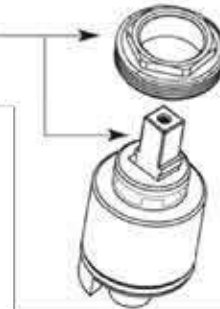

Two Handle Ceramic Style
Replacement Cartridge

- 242905 (Hot)
- 242909 (Cold)



**DUFF is the largest stocking distributor
of MOEN Commercial in the region!**

**DUFF
DELIVERS**



MOEN COMMERCIAL
Electronic Faucets

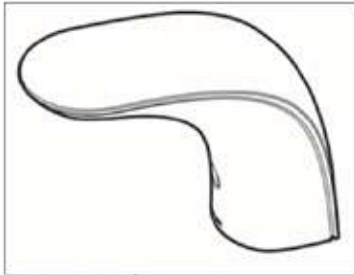

MOEN Electronic Above-Deck Faucet

MODEL	POWER
8553	4 AA BATTERIES (INCL)
8553AC	12V AC L TRANSFORMER
174058	AC TRANSFORMER ONLY

- Metal construction with chrome plated finish
- 2 piece clamshell design for easy installation & maintenance
- Single mount
- Vandal Mode: 30 second time-out feature
- Sentinel Flow: Eliminates stagnant water in supply lines every 24 hours (factory setting – off)
- Maintenance / Cleaning Mode: Allows for a 30 second deactivation for maintenance or cleaning
- Battery 4(AA) or AC powered
- Low battery indicator light
- Battery life: Up to 6 years or 350,000 cycles*
- Built-in mixing-manual on/off handle (8554AC/8554 models)
- In-line filters included
- ADA compliant

* Typical alkaline battery life at 200 uses per day is about 3 years

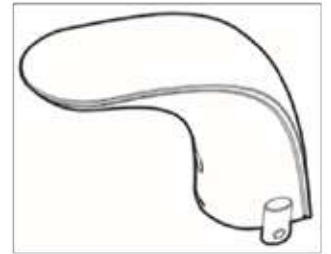
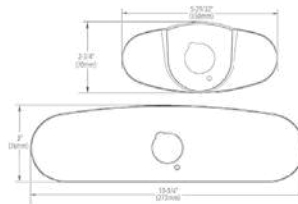

MOEN Electronic Above-Deck Faucet (Mixing)
Designed to be installed through one hole 1-1/4" min. dia.

MODEL	POWER
8554	4 AA BATTERIES (INCL)
8554AC	12V AC L TRANSFORMER
174058	AC TRANSFORMER ONLY

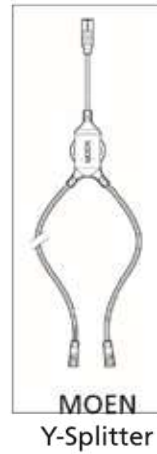
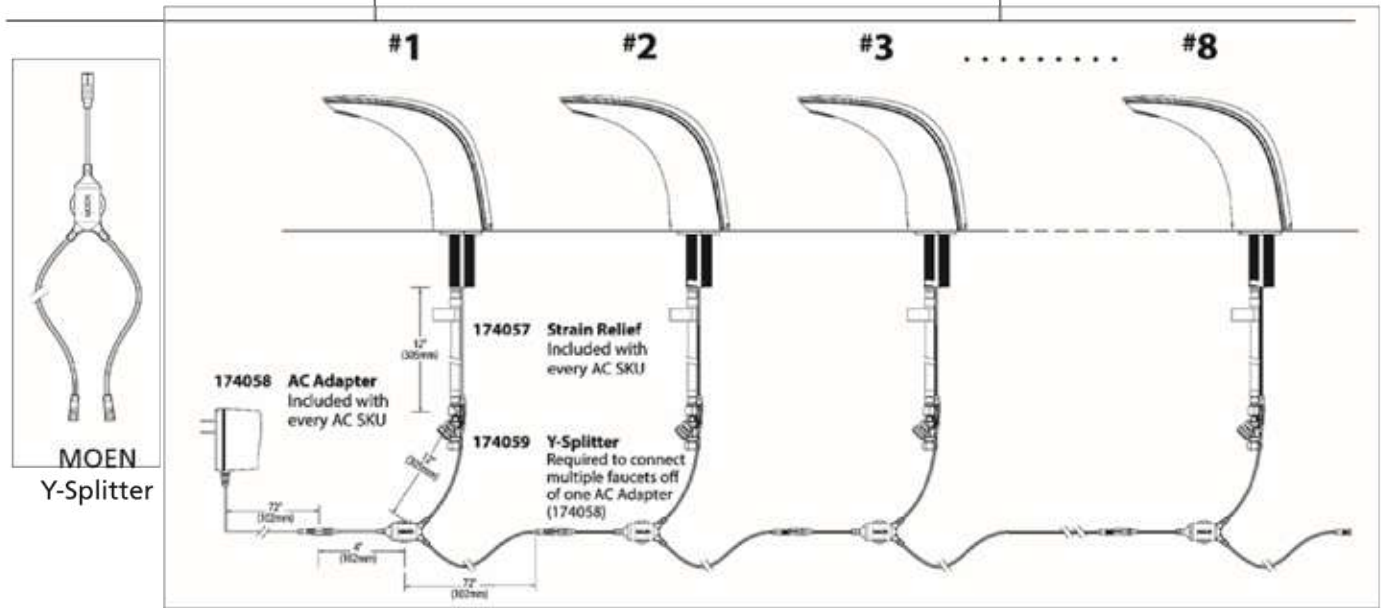

DUFFNOTE:

Call or email DUFF today for the full selection of MOEN commercial products!

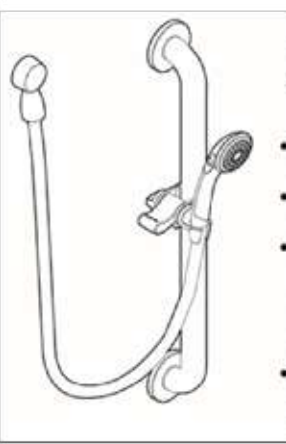

- MOEN Handheld Shower with Slide Bar/Grab Bar
- Metal and brass construction with Chrome plated finish
 - Single function handheld shower with non-positive shut off
 - Contains: hand-held shower, stainless steel, 1 1/2" dia. slide bar grab bar, drop ell, vacuum breaker, 69" metal hose and mounting hardware
 - Easy cleaning rubber nozzles
- MODEL**
52224

MOEN Vandal-Proof Showerhead

- Fixed mount vandal resistant showerhead
- Chrome plated metallic spray face and shell
- Brass swivel ball assembly
- Single-function spray pattern
- Adjustable spray angle*
- * (Only serviceable by professional installer)
- Mounting hardware included

MODEL
8290



DELTA Kitchen Faucets



DELTA 2100LF
2-Handle Kitchen Faucet

- Classic Series
- Two Handle Deck Mount
- 3 Hole Sink Applications
- Solid brass fabricated body
- 1/2"-14 NPSM threaded male inlet shanks.

MODEL	FIG NO.
2110LF	38695



DELTA 2400LF
2-Handle Kitchen Faucet
With Spray

- Classic Series
- Two Handle Deck Mount
- 3 and 4 Hole Sink Applications
- Solid brass fabricated body
- 1/2"-14 NPSM threaded male inlet shanks

MODEL	FIG NO.
2400LF	39078



DELTA B1310LF
Single Handle
Kitchen Faucet

- Single Handle Deck Mount
- 3 Hole Sink Applications
- 8" Centerset
- 1/2"-14 NPSM threaded male inlet adapters

MODEL	FIG NO.
B1310LF	17745



DELTA B4401LF
Single Handle Kitchen
Faucet With Side Spray

- Single Handle with Side Spray
- 4 Hole Sink Applications
- 8" Centerset
- 1/2"-14 NPSM threaded male inlet adapters.

MODEL	FIG NO.
B4401LF	248357



DELTA 101LF

- Classic Series
- Single Handle Deck Mount
- Single Sink Applications
- Standard 8" long spout swings 360°
- 3/8" O.D. copper tube inlets - 10"

MODEL	FIG NO.
101LF	51419



DELTA 300-DST

- Single Handle Deck Mount
- 3 Hole Sink Applications
- DIAMOND Seal® Technology
- Integrated Supply Tubes
- 8" long spout swings 180°.
- 3/8" O.D. straight, staggered pex supply tubes

MODEL	FIG NO.
300-DST	37982



Call or email **DUFF**
for **ALL** your Delta
Faucet needs!



DELTA 570LF-WFHDF

- Classic Series
- Single Handle
- Deck Mount
- 1 Hole Sink Applications
- 4" long spout swings 360°

MODEL	FIG NO.
570LF-WFHDF	30109

DELTA Lavatory Faucets



DELTA 2520LF-MPU

- Classic Series
- Two Handle Deck Mount
- 2 and 3 Hole Sink Applications
- 4" Centerset
- 1/2"-14 NPSM threaded male inlet shanks.

MODEL	FIG NO.
2520LF-MPU	40938



DELTA 501-DST

- Classic Series
- DIAMOND Seal® Technology
- Single Handle Deck Mount
- 3 Hole Sink Applications
- 4" Centerset
- 3/8" O.D. straight, staggered pex supply tubes

MODEL	FIG NO.
501-DST	38082



DELTA 510LF

- Single Handle Deck Mount
- 3 Hole Sink Applications
- 4" Centerset
- Solid brass fabricated body
- 1/2"-14 NPSM threaded male inlet adapters
- Includes metal pop-up type fitting with plated metal flange and stopper cap

MODEL	FIG NO.
510LF	250280



DELTA B501LF

- Single Handle Deck Mount
- 3 Hole Sink Applications
- 4" Centerset
- Solid brass fabricated body.
- 1/2"-14 NPSM threaded male inlet adapters

MODEL	FIG NO.
B501LF	252689



DELTA
Showers and Parts

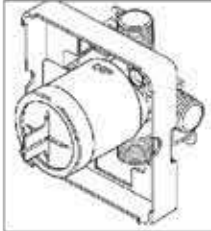

DELTA R10000-UNBX
UNIVERSAL ROUGH
VALVE BODY

- Forged brass body
- 1/2" outlets and connections

MODEL	FIG NO.
R10000-UNBX	185986

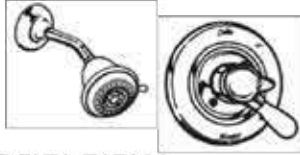

DELTA T17230
TUB AND SHOWER
FAUCET TRIM

- Monitor® 17 Series pressure balanced bath mixing valve trim
- Maintains a balanced pressure of hot and cold water
- Red/Blue indicators on handle
- Lever volume control handle; temperature adjustment dial

MODEL	FIG NO.
T17230	185985

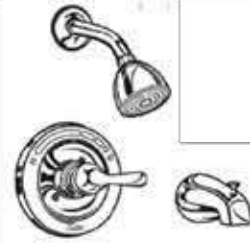

DELTA T13420
TUB AND SHOWER
FAUCET TRIM

- Temperature only controlled with metal lever handle
- Field adjustable to limit handle rotation into hot water zone

MODEL	FIG NO.
T13420	310880

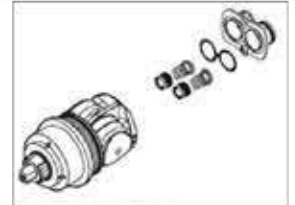

DELTA RP46463
Replacement Cartridge
Assembly

Monitor single-function pressure-balance cartridge. For MultiChoice 17 series tub & showers (after March 2006). Allows for separate volume and temperature control.

MODEL	FIG NO.
RP46463	259616



DELTA 51551-WHB

- ABS hand held shower with two settings
- 70" ultra-flex hose
- ADA compliance applies to the hand shower and hose only

MODEL	FIG NO.
51551-WHB	168448



DELTA RP46384
LOWFLOW
SHOWERHEAD

- Full spray function
- 1.5 GPM @ 80 PSI

MODEL	FIG NO.
RP46384	234236



DELTA RP330
Aerator -
2.2gpm

CHROME. For Classic kitchen and lavatory models and e-FLOW lavatory models. 15/16" - 27 male thread. Order RP25077 for Classic bar/prep modes 2178 and 2179. Available as carded part. 2.2 gpm @ 60 psi, 8.3 L/min @414kPa

MODEL	FIG NO.
RP330	37619



DELTA RP5648
Stopper

MODEL	FIG NO.
RP5648	39071



DELTA RP3816
3" Hole Cover
Fits 3" diverter hole. Stick-on decorative cover.

MODEL	FIG NO.
RP3816	42699



DELTA RP5649
Push Button
Diverter Assembly
CHROME-For single handle tub & showers.

MODEL	FIG NO.
RP5649	33195



DELTA RP39360
White Spray Hose
Assembly
For Classic kitchen models. To be used for non-DIAMOND Seal Technology models.

MODEL	FIG NO.
RP39360	186963



DELTA RP50
Cap Assembly
w/adjustment ring
For use with single handle kitchen faucets.

MODEL	FIG NO.
RP50	33191



DELTA RP19804
Cartridge Assembly
Monitor single-function pressure-balance cartridge. For old Monitor 1300/1400 series tub & showers.

MODEL	FIG NO.
RP19804	89266



DELTA RP50587
Single Handle
Valve Cartridge
For use with single handle DIAMOND Seal Technology faucets. Diamond embedded ceramic cartridge.

MODEL	FIG NO.
RP50587	265354



DELTA RP70
Ball Assembly - Lever
For single lever handle faucets. Excludes 1300-1800 tub & showers.

MODEL	FIG NO.
RP70	43671



DELTA R212
Ball Assembly
For single knob handle faucets. Excludes 1300-1800 tub & showers.

MODEL	FIG NO.
RP212	44700



DELTA RP8230MBS
Two Handle Ceramic
Stem Unit, with
Ring & Spring
For two handle & basin faucets.

MODEL	FIG NO.
RP8230	45432



DELTA RP25513
Stem Assembly
For two handle faucets. Brass Stem. Includes 1/4 turn stop.

MODEL	FIG NO.
RP25513	213807



DELTA
Most Common Replacement Parts



DELTA RP1740 Stem Assembly
For two handle faucets.

MODEL	FIG NO.
RP1740	41838



DELTA RP46074 Cartridge Assembly - Multichoice® 13/14 Series Monitor single-function pressure-balance cartridge. For MultiChoice 13/14 series (after 3/2006).

MODEL	FIG NO.
RP46074	214096



DELTA RP4993 Seats & Springs
2 sets of seats & springs.

MODEL	FIG NO.
RP4993	15703



DELTA 1991 Cartridge Unit
For 1600 series tub & showers.

MODEL	FIG NO.
RP1991	48888



DELTA RP32104 Cartridge Assembly - Monitor® 17 Series Monitor dual-function pressure-balance cartridge. For Monitor 1700 series (after 3/2006). Allows for separate volume and temperature control.

MODEL	FIG NO.
RP32104	199847

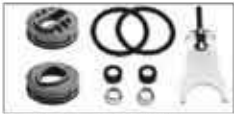

DELTA RP3614 Repair Kit Single Handle Knob or Lever
Assorted parts: 2-seats & springs, 2 o-rings, cam & packing, allen wrench.

MODEL	FIG NO.
RP3614	44705



DELTA RP63137 Aerator - Round Spray 15/16" - 27 male thread. 55/64" - 27 female thread. 2.2 gpm @60 psi, 16.7L/min @ 414kPa

MODEL	FIG NO.
RP63137	37623



DELTA RP2393 Single Lever Handle Kit with set screw
For use on Classic non-DIAMOND Seal Technology models.

MODEL	FIG NO.
RP2393	33192



DELTA RP17451 Single Clear Knob Handle Kit
Clear knob handle. Hot/Cold indicator(s). Sold as single handle. Includes button & screw. For lavatory, basin, and bidet applications.

MODEL	FIG NO.
RP17451	50720



DELTA RP1001 Soap/Lotion Dispenser

MODEL	FIG NO.
RP1001	42151

DUFFNOISE 

Call or email DUFF for ALL your Delta Faucet needs!

DUFF TIP: 

Always keep plenty of spare parts on hand for emergencies.

DUFF DELIVERS



DELTA PARTS

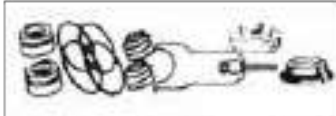

DELTA KIT - To repair all single lever faucets; lav, kitchen, tub & shower.

FIG. NO.	PRICE
15102	



DELTA O-RING - For single handle kitchen deck faucets manufactured since 1969 except pull-out spray models (blue dot O Ring only).

FIG. NO.	PRICE
44702	



DELTA REPLACEMENT SPOUT - For Delta kitchen faucets, 8" length.

FIG. NO.	PRICE
33196	

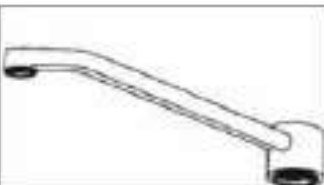

DELEX REPLACEMENT SPOUT - For Delta/Delex, 8" length.

FIG. NO.	PRICE
48469	



DELTA/DELEX SEATS & SPRING KIT - Contains 2 old style, 2 new style seats and springs, 8 pieces total.

FIG. NO.	PRICE
15103	

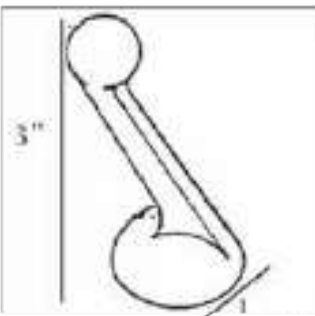

DELTA REPLACEMENT LEVER HANDLE
Lavatory, Bath

FIG. NO.	PRICE
47113	

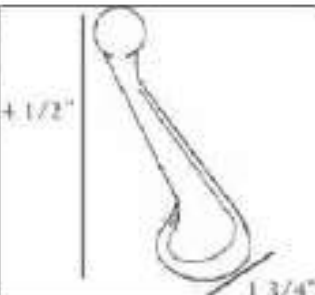

DELTA kitchen REPLACEMENT LEVER HANDLE

FIG. NO.	PRICE
33192	



DELTA REPLACEMENT BALLS

FIG. NO.	PRICE
Stainless 43671	
Plastic 15105	
Brass 58476	

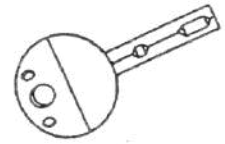

DELTA #212 "Diamond Ball"

FIG. NO.	PRICE
44700	

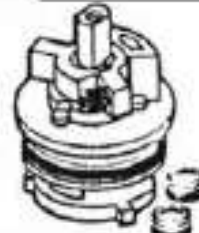

DELTA CARTRIDGE - For Delta Scaldguard tub & shower.

FIG. NO.	PRICE
48888	

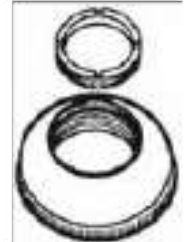

DELTA CAP AND RING KIT - CP Brass cap and adjusting ring to repair all single lever and knob faucets.

FIG. NO.	PRICE
33191	



DELTA BALANCING SPOOL

FIG. NO.	PRICE
42517	

DUFF DIFFERS

ALL DELTA PARTS AVAILABLE IN BULK!

DELTA PARTS

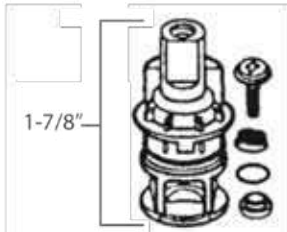

**DELTA DELEX
CARTRIDGE.**

FIG. NO.	PRICE
45432	



**DELTA STEM
UNIT - for two
handle and basin
faucets (except
slow close)**

FIG. NO.	PRICE
41838	



DELTA ADJUSTABLE RING:
For single handle faucets
(except 1300, 1400, 1500,
tub/shower series).

FIG. NO.	PRICE
37621	



**DELTA CAM & PACKING -
for single lever handle faucets.**

FIG. NO.	PRICE
47114	

**DELTA
PUSH BUTTON
DIVERTER**

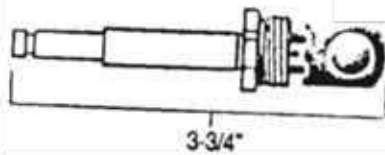

FIG. NO.	PRICE
2-handle	48471
single lever	33195

DELTA POP-UP PLUG



**ALSO REPLACES OLD
STYLE THAT LOOKS LIKE
THIS!**



FIG. NO.	PRICE
39071	



**DELTA
DIVERTER
ASSEMBLY:**
For single handle kitchen
deck faucets.

FIG. NO.	PRICE
47992	



DELTA Chrome 3" Cover



FIG. NO. 42699

DELTA SHOWER COVER-UP PLATE

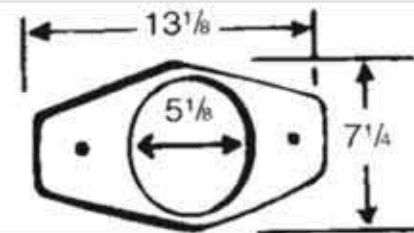

Covers up to 8" center holes

FIG. NO.	PRICE
7856	

**DELTA SPRAY
'ROUND SWIVEL
AERATOR -
15/16" 27 male
thread or 55/64"
27 female thread.**



FIG. NO.	PRICE
37623	

DUFF IS ALWAYS

OPEN

365 DAYS A YEAR

24 HOUR EMERGENCY SERVICE

ECONOMY FAUCETS



Rough Brass Laundry Tray
Faucet

FIG. NO.	PRICE
8147	

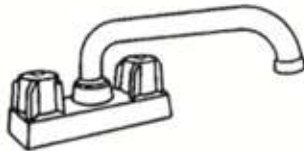

Chrome Plated Laundry Tray
Faucet

FIG. NO.	PRICE
14582	



8" Combination Wall
Faucet

FIG. NO.	PRICE
66137	



Economy Basin Cock

FIG. NO.	PRICE
19423	

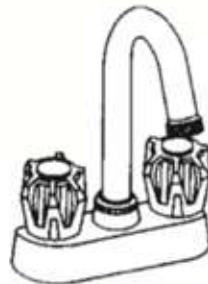

Economy 4" Bar Faucet

FIG. NO.	PRICE
14581	



#3" Bath Cock

FIG. NO.	PRICE
8272	



Bath Offset Couplings
(PR) For #3 Bath Cock

FIG. NO.	PRICE
19787	



#0 Bath Cock

FIG. NO.	PRICE
8265	



Bath Faucet Coupling
Elbow (PR) For #0
Bath Cock

FIG. NO.	PRICE
19611	

Don't see what
you're looking
for?

Just Ask Us!!

PEERLESS®

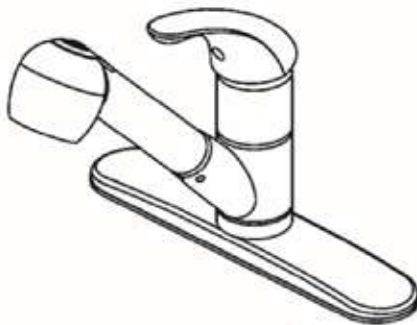

PEERLESS P18550LF
Single handle, lever, pull-out
kitchen faucet,
2 function wand.

FIG. NO.
241276

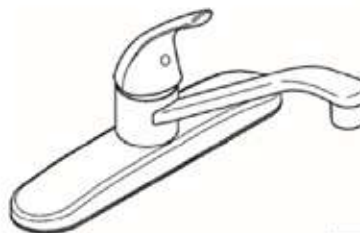
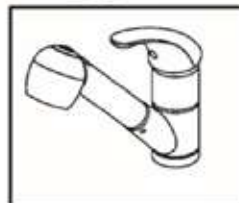

PEERLESS P110LF Economy
Washerless Brass Single
Lever Faucet

Chrome-plated efficient
water saver aerator, brass ball.
Uses Delta Repair Kit.

FIG. NO.	TYPE
248945	NO SPRAY
232682	SPRAY



PEERLESS P188620LF
Economy Washerless
Lavatory Faucet

Single handle, lever, centerset
lavatory faucet metal pop-up drain
assembly. Uses Delta Repair Kit.

FIG. NO.
246905



COMMERCIAL KITCHEN PARTS



Lever Waste Installation Tool
For removal or installation of any Franklin 1100 or 1200 series wastes with 3" or 3 1/2" openings.



Heavy Duty stainless steel construction

FIG. NO.

38843



DIPPER WELL FAUCET

2" Spout
1/2" NPS Shank
Chrome Plated Finish

FIG. NO.

17623



URN FAUCET
Chrome Plated Brass

FIG. NO.

17630



CHG ENCOR STEM

FIG. NO.	DESCRIPTION
257096	KN41-Y007 HOT
257095	KN41-Y006 COLD



Wall-Mount Shell Body Faucet Kit for Hand Sink

FIG. NO.

142613

Franklin Bronze Body Wastes with Drain Reducer

- 2" NPS male connection and 1-1/2" NPS female connection
- Can be used with or without 1-1/4" overflow head and elbow
- Includes nickel-plated brass reducer (Duff Fig. No. 52696) to convert the 2" male connection to 1-1/2" male connection
- Stainless steel drain, flange and handle



Lever

Twist

FIG. NO.	SINK OPENING	FLANGE DIAMETER	TYPE
224881	3"	4-1/8"	Twist
224091	3-1/2"	4-3/8"	Twist
50873	3"	4-1/8"	Lever
17626	3-1/2"	4-3/8"	Lever
52696	2" NPT female X 1-1/2" NPT male reducing adapter		

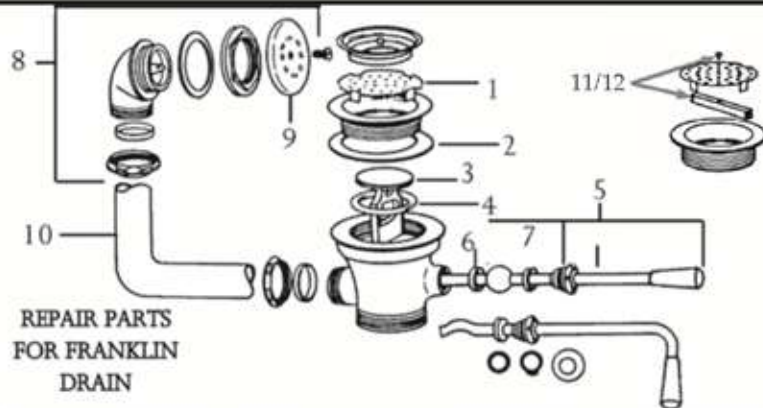

REPAIR PARTS FOR FRANKLIN DRAIN

	DESCRIPTION	FIG. NO.	PRICE
1	Strainer - 3" Opening 3 1/8" Diameter	18933	
	Strainer - 3" Opening 3 7/16" Diameter	18934	
2	Washer - 3" sink opening	18936	
	Washer - 3 1/2" sink opening	18937	
3	Plunger with O-ring	18932	
4	O-Ring	18931	
5	Lever Rod	18940	
6	Body Bushing	18939	
7	Packing Nut Bushing	48602	
8	Overflow head assembly	38795	
9	Overflow strainer	18927	
10	Overflow elbow-1 1/4"OD x 14"X18"	38796	
11	Strainer Lock 3"	23803	
12	Strainer Lock 1 1/2"	148027	

Waste Repair Kit

Contains common replacement parts for all Franklin Machine Products lever and twist wastes, component hardware group wastes and standard Keil wastes.

Contains 1 of each: 3" and 3 1/2" flange washers, body bushing, packing nut bushing, plunger o-ring, coupling nut washer, handle o-ring, twist handle snap rings, washer.



FIG. NO.

18941



FIG. NO.

33950

Waste Repair Kit

Contains common replacement parts for all Franklin Machine Products OLD STYLE 3976 and 3979 series lever wastes. Contains 1 of each: flange washer, coupling nut washer, body bushing, packing nut bushing, o-ring.



Hot and Cold Water Workboard Sink Faucet

- 4" Fixed Centers
- GN2AAB - 5-1/4" Rigid / Swing Gooseneck Spout
- E35AB - 1.5 GPM Aerator
- 369-PR - 2-3/8" Vandal Proof Lever Handle
- Ceramic 1/4 Turn Operating Cartridge
- 1/2" NPSM Supply Inlets



Hot and Cold Water Sink Faucet

- 4" Fixed Centers
- GN1AAB - 3-1/2" Rigid / Swing Gooseneck Spout
- E3AB - 2.2 GPM Aerator
- 317-PR - 4" Vandal Proof Wristblade Handle
- XTAB - Quatern Compression Operating Cartridge
- 1/2" NPSM Supply Inlets and Coupling Nut for 3/8" or 1/2" Flexible Riser



Fig No.
2462253

Hot and Cold Water Sink Faucet

- 8" Fixed Centers
- GN1AAB - 3-1/2" Rigid / Swing Gooseneck Spout
- E3AB - 2.2 GPM (8.3 L/min) Aerator
- 1000-PR - 2" Vandal Proof Canopy Single Wing Handle
- XTAB - Quatern Compression Operating Cartridge
- 1/2" NPSM Supply Inlets and Coupling Nut for 3/8" or 1/2" Flexible Riser



Fig No.
308440

Single Lever Hot & Cold Water Mixing Sink Faucet

- 8" Fixed Centers
- 9 1/2" Center to Center Integral Cast Brass Spout
- E37AB - 1.5 GPM Non-Aerating Outlet
- 420-XAB - Volume Control and Hot Water Limit Stop Cartridge
- 1/2" NPSM Supply Inlets for 3/8" or 1/2" Flexible Riser
- User Adjustable Temperature Control Mixer
- Temperature Limiter
- Available with or without side spray



Fig No.	
271504	W/Spray
271505	W/O Spray

Push Button Drinking Fountain

- Single Hole
- 665-PSH - 1-3/4" Vandal Proof MVP Metering Push Handle
- 672-XAB - Cartridge
- 1/2" NPSM Supply Inlet and Coupling Nut for 3/8" or 1/2" Flexible Riser
- Anti-Rotational Pins for Optional Field Installation
- Vandal Resistant Recessed Manual Volume Control
- Anti-microbial flexible mouth guard



Fig No.
246257



8" Swing Cast Spout



Fig No.
191216

12" Swing Spout w/aerator



14" Swing Spout w/aerator



8" Rigid Swing Gooseneck



5.25" Rigid Swing Gooseneck



Fig No.
109800

3.5" Rigid Swing Gooseneck



6" Rigid Swing Gooseneck





EQ Series

- Below-deck design. Everything is contained in an easy-to-install, compact control box.
- Match any decor. Three designs in polished chrome or brushed nickel finishes.
- Simple plug-and-play installation. EQ is up and running in a matter of minutes, not hours.
- No need to program. Automatically adjusts to environment for dependable performance.
- Built to last. Choose heavy-duty, solid brass or zinc spout construction.



HyTronic® Series

- Above-deck design for easy installation and maintenance.
- Styles for any application. A choice of 6 faucets styles, 3 power options, and 3 mixing options to meet any application.
- Advanced electronics. With optional commander® handheld programming unit, access additional operating modes, troubleshoot and monitor usage from the palm of your hand.
- Unsurpassed dependability. Tested to over 4 million faultless operations.



E-Tronic® 40

- Above-deck design for easy installation and maintenance.
- Affordable option for public rest rooms. Delivers dependable twin beam infrared operation at an affordable price.
- Commander® compatible. With optional handheld programming unit, adjust and troubleshoot from the palm of your hand.
- Choice of options. Choose the right power and mixing options for your project.



Concealed Hot and Cold Water Sink Faucet

- 8" Fixed Centers
- 5" Center to Center Rigid Cast Brass Spout
- E12VPAB - 2.2 GPM Vandal Proof Aerator
- 317-PRVP - 4" Vandal Proof Wrist-blade Handle
- 377-XTAB - Quatern Compression Operating Cartridge
- 1/2" NPSM Supply Inlets and Coupling Nut for 3/8" or 1/2" Flexible Riser



Fig No.
205580

Concealed Hot and Cold Water Sink Faucet

- 8" Fixed Centers
- GN2AAB - 5-1/4" Rigid / Swing Gooseneck Spout
- E3AB - 2.2 GPM Aerator
- 317-PR - 4" Vandal Proof Wrist-blade Handle
- 377-XKAB - Ceramic 1/4 Turn Operating Cartridge
- 1/2" NPSM Supply Inlets and Coupling Nut for 3/8" or 1/2" Flexible Riser



Fig No.
259740

Concealed Hot and Cold Water Metering Sink Faucet

- 8" Fixed Centers
- 5" Center to Center Rigid Cast Brass Spout
- E12VPAB - 2.2 GPM Vandal-Proof Aerator
- 665-PR - 1-3/4" Vandal Proof MVP Metering Push Handle
- MVPAB - MVP Metering Adjustable Cycle Time Closure Cartridge
- 1/2" NPSM Supply Inlets and Coupling Nut for 3/8" or 1/2" Flexible Riser



Fig No.
246255

Hot and Cold Water Metering Sink Faucet

- 4" Fixed Centers
- 4" Center to Center Integral Cast Brass Spout
- E12VPAB - 2.2 GPM Vandal Proof Aerator
- 665-PR - 1-3/4" Vandal Proof MVP Metering Push Handle
- MVPAB - MVP Metering Adjustable Cycle Time Closure Cartridge
- 1/2" NPSM Supply Inlets and Coupling Nut for 3/8" or 1/2" Flexible Riser



Fig No.
264214

Vacuum Breaker Repair Kit



Fig No.
195373

Pre-Rinse Spray Valve

Integrated Stainless Handle Clip to Hold Handle Open
 One Piece Stainless Steel Spray Nozzle and Diffuser
 Rubber Nozzle Bumper
 3/4" - 14 UNS Male Thread Inlet
 All Valve Components are Serviceable
 Compatible with Fisher and T&S Hoses
 Chrome Plated Brass Handle with PVC Coating for Heat Resistance



Fig No.
271497

44" Stainless Steel Hose/ Handle Assembly

- 3/8"-18 NPT Male Thread Inlet
- 3/4"-14 UNS Female Thread Outlet
- Insulated Sleeve Handle
- includes adapters for Fisher and T&S Pre-rinse Valves
- ECAST® construction with equal to or less than 0.25% lead content by weighted average



Fig No.
271506

*Call Duff
for all your
plumbing
needs.*

**DUFF
DELIVERS**

est. 1947

DUFF CO.

When you need it now... or don't know how



For additional information call: 610-275-4453 or Fax: 610-279-6299
 Please call for current prices.

WATER FOUNTAINS & PARTS

<p>T&S B-2360 Deck-Mount Self-Close Bubbler</p> <ul style="list-style-type: none"> Lever Handle Rubber bubbler guard <p>FIG. NO. 190696</p>	<p>T&S B-2360-03 Deck-Mount Self-Close Bubbler</p> <ul style="list-style-type: none"> Pushbutton All brass <p>FIG. NO. 275310</p>	<p>Elkay Self-Close Deck-Mount Classroom Bubbler</p> <ul style="list-style-type: none"> Push button Rubber bubbler guard <p>FIG. NO. 257100</p>	<p>Central Brass 364-L Deck-Mount Self-Close Bubbler</p> <ul style="list-style-type: none"> Lever handle All brass Adjustable flow regulator <p>FIG. NO. 234724</p>	<p>Central Brass 365-L Self-Close Drinking Faucet</p> <ul style="list-style-type: none"> Lever Handle All brass <p>FIG. NO. 8576</p>
--	--	--	---	---

<p>Central Brass Self-Close 366-L Drinking Faucet</p> <ul style="list-style-type: none"> Lever Handle All brass Back-mounted <p>FIG. NO. 8577</p>	<p>Central Brass Bubbler Replacement Cartridge</p> <p>FIG. NO. 18564</p>	<p>Bubbler Cartridge for Sunroc, Elkay and Halsey Taylor</p> <table border="1"> <thead> <tr> <th>FIG. NO.</th> <th>DESCRIPTION</th> </tr> </thead> <tbody> <tr> <td>6422</td> <td>Stainless steel cartridge / spring</td> </tr> <tr> <td>79236</td> <td>Plastic cartridge / green spring</td> </tr> <tr> <td>112944</td> <td>Plastic cartridge / red spring</td> </tr> </tbody> </table>	FIG. NO.	DESCRIPTION	6422	Stainless steel cartridge / spring	79236	Plastic cartridge / green spring	112944	Plastic cartridge / red spring	<p>Oasis Valve Assembly</p> <p>FIG. NO. 201471</p>
FIG. NO.	DESCRIPTION										
6422	Stainless steel cartridge / spring										
79236	Plastic cartridge / green spring										
112944	Plastic cartridge / red spring										

<p>Halsey Taylor Push Button Stem Assembly</p> <p>FIG. NO. 111745</p>	<p>Regulator Kit for Elkay and Halsey Taylor</p> <table border="1"> <thead> <tr> <th>FIG. NO.</th> <th>DESCRIPTION</th> </tr> </thead> <tbody> <tr> <td>275141</td> <td>Red spring</td> </tr> <tr> <td>248100</td> <td>Green spring</td> </tr> </tbody> </table>	FIG. NO.	DESCRIPTION	275141	Red spring	248100	Green spring	<p>Regular Kit for Oasis and Sunroc</p> <p>FIG. NO. 89711</p>	<p>Halsey Taylor Right Flow Regulator Valve Assembly</p> <table border="1"> <thead> <tr> <th>FIG. NO.</th> <th>DESCRIPTION</th> </tr> </thead> <tbody> <tr> <td>251314</td> <td>Complete</td> </tr> <tr> <td>17547</td> <td>Regulator only</td> </tr> </tbody> </table>	FIG. NO.	DESCRIPTION	251314	Complete	17547	Regulator only
FIG. NO.	DESCRIPTION														
275141	Red spring														
248100	Green spring														
FIG. NO.	DESCRIPTION														
251314	Complete														
17547	Regulator only														



BRADLEY FIXTURES & PARTS



<p>Thermostatic High-Low Valve</p> <ul style="list-style-type: none"> Liquid-filled thermostat Integral strainer checkstops Accurate Temperature Control to within $\pm 3^{\circ}$ F Positive Shutoff of Flow in the Event of Cold Supply Line Failure or Thermostat Failure 90° F to 120° F (other ranges available) <p>FIG. NO. 279984</p>	<p>Metering Valve</p> <table border="1"> <thead> <tr> <th>FIG. NO.</th> <th>DESCRIPTION</th> </tr> </thead> <tbody> <tr> <td>247940</td> <td>Repair Kit (10-12 sec cycle time)</td> </tr> <tr> <td>61578</td> <td>Repair Kit (5-7 sec cycle time)</td> </tr> <tr> <td>247782</td> <td>Set screws only</td> </tr> </tbody> </table>	FIG. NO.	DESCRIPTION	247940	Repair Kit (10-12 sec cycle time)	61578	Repair Kit (5-7 sec cycle time)	247782	Set screws only	<p>Compression Valve for Shower Tower</p> <ul style="list-style-type: none"> Complete valve, stem and handle assembly <table border="1"> <thead> <tr> <th>FIG. NO.</th> <th>DESCRIPTION</th> </tr> </thead> <tbody> <tr> <td>244114</td> <td>Cold</td> </tr> <tr> <td>244115</td> <td>Hot</td> </tr> </tbody> </table>	FIG. NO.	DESCRIPTION	244114	Cold	244115	Hot	<p>Emergency Fixture Thermostatic Mixing Valve</p> <ul style="list-style-type: none"> Liquid-filled thermostat Checkstops Accurate Temperature Control to within $\pm 3^{\circ}$ F Positive flow shutoff in the event of thermostat or cold supply line failure Built-in Cold Water Bypass, Assuring Cold Flow
FIG. NO.	DESCRIPTION																
247940	Repair Kit (10-12 sec cycle time)																
61578	Repair Kit (5-7 sec cycle time)																
247782	Set screws only																
FIG. NO.	DESCRIPTION																
244114	Cold																
244115	Hot																

DUFF CO. OFFERS OTHER BRADLEY AND ACORN WASHROOM ACCESSORIES....

<p>PATIENT CARE</p> 	<p>PENAL FIXTURES</p> 	<p>WASH BASINS</p> 	<p>EMERGENCY SAFETY EQUIPMENT</p> 	<p>WASHROOM ACCESSORIES</p> 
---	--	---	---	--

FLUSHOMETERS

SLOAN.

Sloan Royal Manual Flushometer

- PERMEX® Synthetic Rubber Diaphragm w/Dual Filtered Fixed Bypass
- ADA-compliant handle
- Sweat solder adapter w/cover tube & cast wall flange w/set screw
- Vandal-resistant stop cap



FIG	TYPE	SUPPLY	TAILPIECE	MFR NO.
7198	Urinal 1.5 gpf	3/4"	3/4"	186
143820	Urinal 1.0 gpf	3/4"	3/4"	186-1
7194	Urinal 3.5 gpf	1"	1-1/4"	180
164402	Urinal 1.5 gpf	1"	1-1/4"	180-1.5
47353	Closet 1.6 gpf	1"	1-1/2"	111
7191	Closet 3.5 gpf	1"	1-1/2"	110

SLOAN.

Sloan Regal Manual Flushometer

- Diaphragm type
- ADA-compliant handle
- Sweat solder adapter w/cover tube & cast wall flange w/set screw
- Sloan's competitive Flushometer

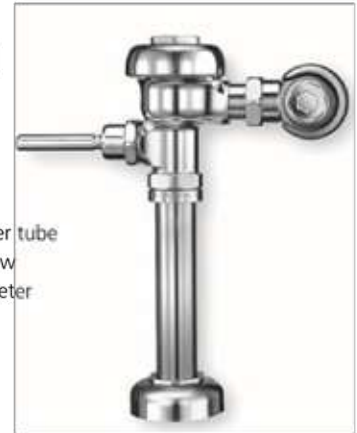

FIG	TYPE	SUPPLY	TAILPIECE	MFR NO.
232814	Urinal 1.5 gpf	3/4"	3/4"	Regal 186XL
232813	Closet 1.6 gpf	1"	1-1/2"	Regal 111XL
232812	Closet 3.5 gpf	1"	1-1/2"	Regal 110XL

You want Sloan?
DUFF's got Sloan like nobody else.

SLOAN.

Sloan Royal Bedpan Washer

- Incorporates all features of the Royal Flushometer
- Bedpan Washer Diverter Assembly includes:
 - Solid One-piece Body Construction
 - Solid Brass Spray Arm
 - Counter Balanced Pivot Assembly
 - Diverter Valve Wall Support



FIG	TYPE	SUPPLY	TAILPIECE	MFR NO.
20652	3.5 gpf	1"	1-1/2"	BPW-1000-3.5
279827	1.6 gpf	1"	1-1/2"	BPW-1000-1.6

SLOAN.

Sloan G2 Optima Plus Sensor Flushometer

- ADA Compliant OPTIMA Plus® Battery Powered Infrared Sensor
- Four (4) Size AA Batteries factory installed
- Courtesy Flush® Override Button



FIG	TYPE	SUPPLY	TAILPIECE	MFR NO.
49404	Urinal 1.5 gpf	3/4"	3/4"	8186
50237	Urinal 3.5 gpf	3/4"	1-1/4"	8180
50236	Closet 1.6 gpf	1"	1-1/2"	8111
49331	Closet 3.5 gpf	1"	1-1/2"	8110

SLOAN.

Sloan Royal Optima Sensor Flushometer

- ADA Compliant OPTIMA® EL-1500-L Self-Adaptive Infrared Sensor with Indicator Light
- Hard-wired (transformer not included)
- Courtesy Flush™ Override Button
- Incorporates all features of the Royal Flushometer



FIG	TYPE	SUPPLY	TAILPIECE	MFR NO.
43205	Urinal 1.5 gpf	3/4"	3/4"	186-ES-S
218701	Urinal 1.0 gpf	3/4"	3/4"	186-1 ES-S
50234	Closet 1.6 gpf	1"	1-1/2"	111 ES-S
--	Closet 3.5 gpf	1"	1-1/2"	110 ES-S

FLUSHOMETERS



Zurn Aquasense AV Sensor Flushometer

- Diaphragm type
- ADA Compliant, Sensor with Indicator Light
- Four (4) AA Batteries Included
- Automatic 24-Hour Flush

Fig. No.	Type	Supply	Tail-piece	Mfr No.
—	Urinal 1.5 gpf	3/4"	3/4"	ZR6003AV-STDFLUSH
—	Urinal 1.0 gpf	3/4"	3/4"	ZR6003AV-WS1
—	Closet 1.6 gpf	1"	1-1/2"	ZR6000AV-WS1
—	Closet 3.5 gpf	1"	1-1/2"	ZR6000AV-STDFLUSH



ZURN AquaFlush Manual Flushometer

- Diaphragm type
- ADA-compliant handle
- Sweat solder adapter w/cover tube & cast wall flange w/set screw

FIG	TYPE	SUPPLY	TAILPIECE	MFR NO.
--	Urinal 1.5 gpf	3/4"	3/4"	Z6001-WS
--	Urinal 1.0 gpf	3/4"	3/4"	Z6001-WS1
--	Closet 1.6 gpf	1"	1-1/2"	Z6000-WS1
--	Closet 3.5 gpf	1"	1-1/2"	Z6000-WS



est. 1947

DUFF CO.

When you need it now... or don't know how



FLUSHOMETER PARTS & ACCESSORIES

Zurn E-Z Flush Side-Mount Retrofit Kit

- Provides trouble-free automatic flushing
- Easy install: Just remove handle and install in minutes!
- "C" batteries included
- Fits most leading manufacturer's flushometers
- 2-function wand.



FIG NO.	Type
133662	Chrome-plated metal other variations available

Sloan Optima Plus SMO Retrofit Kit

- Provides trouble-free automatic flushing
- Easy install: Just remove handle and install in minutes!
- "C" batteries included
- Fits most leading manufacturer's flushometers



FIG NO.	TYPE
140298	Chrome-plated metal other variations available

Sloan Dual-Flush Side Mount Retrofit Kit

- Provides trouble-free automatic flushing
- Easy install: Just remove handle and install in minutes!
- "C" batteries included
- Fits most leading manufacturer's flushometers



FIG NO.	TYPE
319159	Dual-Flush
319160	Single-Flush

Sloan Side Mount Over Handle Retrofit Kit

- Allows for mechanical manual override & no need to remove the handle for installation
- "C" batteries included
- Fits most leading manufacturer's flushometers

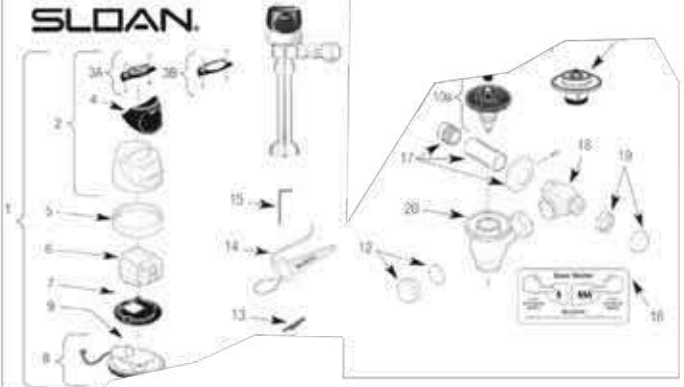

FIG NO.
196644

Sloan ECOS Flushometer Parts

Item.	Part.	Description
Items Included with RESS Retrofit and Complete Sloan ECOS Flush Valves		
1	WES-55-A	Cover/Ring/Sensor Assembly - Dual Flush WC
	EBV-138-A	Cover/Ring/Sensor Assembly - 1.6 & 1.28 gpf Single Flush WC
	EBV-378-A	Cover/Ring/Sensor Assembly - 1.1 gpf Single Flush WC
	EBV-139-A	Cover/Ring/Sensor Assembly - 1.0 gpf Single Flush Urinal
	EBV-341-A	Cover/Ring/Sensor Assembly - 0.5 gpf Single Flush
	EBV-329-A	Cover/Ring/Sensor Assembly - 0.25 gpf Single Flush
	EBV-324-A	Cover/Ring/Sensor Assembly - 0.125 gpf Single Flush
	WES-60-A	Cover/Ring/Sensor Assembly w/ Zurn ring - Dual Flush WC
	EBV-149-A	Cover/Ring/Sensor Assembly w/ Zurn ring - 1.6 & 1.28 gpf Single Flush Water Closet
	EBV-150-A	Cover/Ring/Sensor Assembly w/ Zurn Ring - Single Flush Urinal
2	EBV-191-A	Cover Assembly - Dual Flush
	EBV-142-A	Cover Assembly - Single Flush
3A	WES-23-A	Button Cover Assembly with Screws - Dual Flush
	EBV-130-A	Button Cover Assembly with Screws - Single Flush
3B	EBV-132-A	Screws (2) and Hex Wrench Only
4	EBV-131	Lens Window Cover
5	EBV-168	Locking Ring
	EBV-172	Locking Ring - for Zurn valves
6	EBV-196-A	Module - ECOS Electronic 1.6/1.1 gpf Dual Flush
	EBV-383-A	Module - ECOS Electronic 1.1 gpf Single Flush
	EBV-129-AC	Module - ECOS Electronic 1.6 & 1.28 gpf Single Flush
	EBV-129-AU	Module - ECOS Electronic 0.5 & 1.0 gpf Single Flush
7	EBV-134	Cover Rest Plate
8	EBV-145-A	Inside Cover Assembly (includes solenoid)
9	EBV-136-A	Solenoid
10A		} See Diaphragm Chart
10B		
11		
12	EBV-1017-A	Handle Cap (RESS Retrofit Models only)
13	EBV-91	Range Adjustment Tool
14	EBV-22	Strap Wrench
15	EBV-137	7/64" Hex Wrench
16	WES-19	English Operation Instruction Plate
	WES-22	Spanish Operation Instruction Plate
Items Included with Complete Sloan ECOS Valves Only		
17A	H-633-AA	1" (25 mm) Sweat Solder Kit
17B	H-636-AA	3/4" (20 mm) Sweat Solder Kit
18A	H-700-A	1" (25 mm) Bak-Chek® Control Stop
18B	H-700-A	3/4" (20 mm) Bak-Chek® Control Stop
19	H-1010-A	Vandal Resistant Stop Cap
20	EBV-36-A	Valve Body

SLOAN.



Sloan ECOS Dual-Flush Retrofit Head for Closets

- Automatically initiates a 1.1 gpf or 1.6 gpf flush based on how long user remains in sensor range
- "AA" batteries included
- For Sloan flushometers (other manufacturers retrofits available)



FIG NO.
217492

Sloan G2 Optima Plus Single-Flush Retrofit Head

- Available for either urinals (1.0 - 1.5 gpf) or closets (1.6-3.5 gpf)
- "AA" batteries included
- For Sloan flushometers (other manufacturers retrofits available)



FIG NO.	TYPE
151706	URINAL
217492	CLOSET

ITEM 10. FLEX TUBE DIAPHRAGM KIT

Code No.	Part No.	Description	Regulator Color *
3325090	EBV-1025-A	Urinal-0.25 gpf/1.0 Lpf	GREEN
3325003	EBV-1023-A	Urinal-0.5 gpf/1.9 Lpf**	GREEN
3325000	EBV-1022-A	Urinal-1.0 gpf/3.8 Lpf	GREEN
3325000	EBV-1022-A	Urinal-1.5 gpf/5.7 Lpf †	BLACK
3325001	EBV-1020-A	Urinal-3.5 gpf/13.2 Lpf †	WHITE
3325031	EBV-1024-A	Closet-1.28 gpf/4.8 Lpf	GREEN
3325001	EBV-1020-A	Closet-1.6 gpf/6.0 Lpf †	GREEN
3325014	EBV-1021-A	Closet-2.4 gpf/9.0 Lpf	BLUE
3325001	EBV-1020-A	Closet-3.5 gpf/13.2 Lpf	WHITE
3325001	EBV-1020-A	Closet-4.5 gpf/17.0 Lpf †	WHITE



† EBV-1020-A and EBV-1021-A are supplied with multiple regulators.
 ‡ A 0.5 gpf (1.9 Lpf) urinal kit can be converted to a 1.0 gpf (3.8 Lpf) by cutting and removing the smooth A-164 flow ring from the grate.
 § For a 4.5 gpf (17 Lpf) water closet flush use EBV-1020-A with the white regulator, and cut and remove the A-164 flow ring from the grate.
 * Color of regulator to be used with flex tube diaphragm to obtain the listed flush volume.

DUFF HAS ELECTRONIC REPAIR PARTS **TOTO** **ZURN** **MOEN**
 FOR ALL MANUFACTURERS! **KOHLER** **Delany** **American Standard**

ROYAL FLUSHOMETER

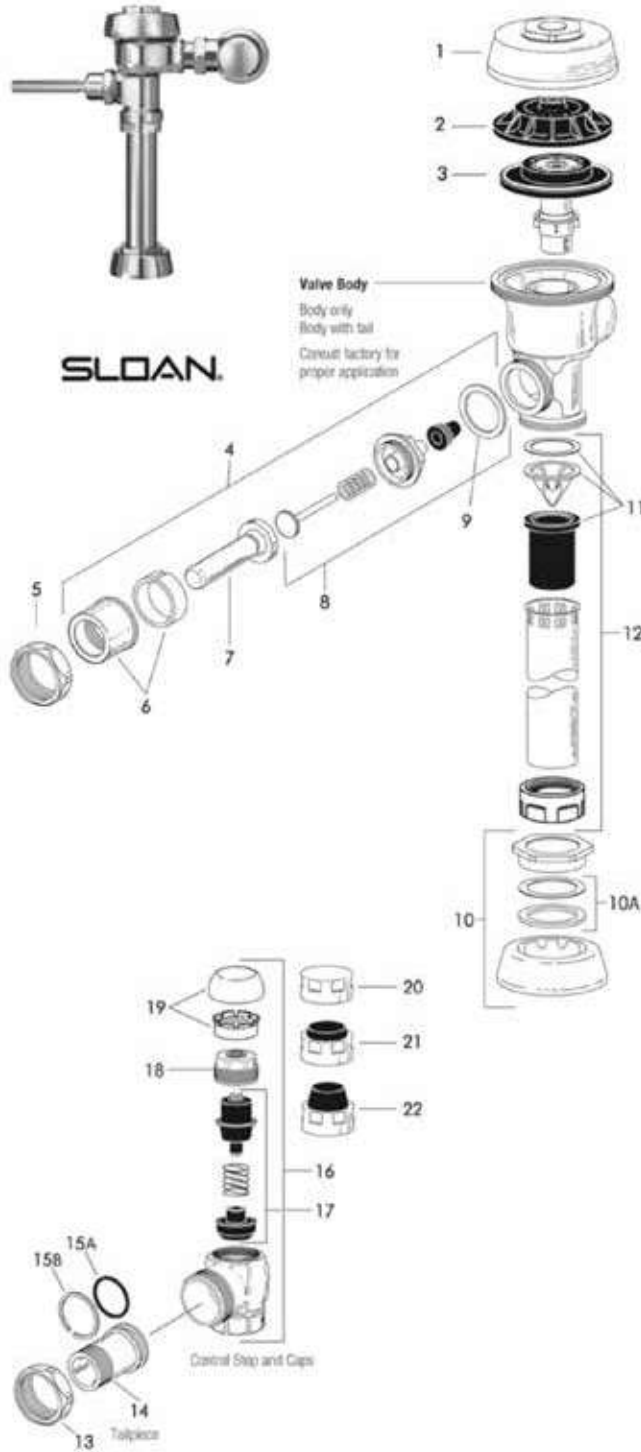

TAILPIECES, CONTROL STOPS AND FLUSH CONNECTIONS

For additional information on tailpieces, control stops and flush connections see Showerheads, Parts and Accessories Tab.

PARTS LIST

Item No.	Code No.	Part No.	Description
1.	0301172	A-72	CP Cover
	—	A-72-HE	CP High Efficiency Cover
2.	0301168	A-71	Inside Cover
3.	—		Dual Filtered Bypass Diaphragm Assembly (refer to table and diagram on following page)
4.	0302390	B-73-A	CP ADA-Compliant Triple Seal Handle Assembly
5.	0301082	A-6	CP Handle Coupling
6.	0302109	B-7-A	CP Socket Assembly
7.	0302389	B-74-A	CP ADA-Compliant Handle
8.	3302306	B-51-A	Triple Seal Handle Repair Kit
9.	5301139	A-31	Handle Gasket – 48 per package
10.	0306125	F-5-AW	3/4" (19 mm) CP Spud Coupling Assembly
	0306140	F-5-AU	1-1/4" (32 mm) CP Spud Coupling Assembly
	0306146	F-5-AT	1-1/2" (38 mm) CP Spud Coupling Assembly
10A.	SEE SLIP JOINT GASKETS AND RINGS TABLE BELOW		
11.	3323182	V-651-A	High Back Pressure Vacuum Breaker Repair Kit
12.	3393004	V-600-AA	3/4" (19 mm) x 9" (228 mm) CP Vacuum Breaker
	3393006	V-600-AA	1-1/4" (32 mm) x 9" (228 mm) CP Vacuum Breaker
	3393007	V-600-AA	1-1/2" (38 mm) x 9" (228 mm) CP Vacuum Breaker
13.	0308676	H-550	CP Stop Coupling
14.	0308801	H-551-A	CP Adjustable Tailpiece 2-1/16" (52 mm long) Standard Length*
15A.	5308696	H-553	O-ring – 24 per package
15B.	5308381	H-552	Locking Ring – 12 per package
16.	3308386	H-700-A	1" (25 mm) CP Bak-Chek® Screwdriver Stop
	3308384	H-700-A	3/4" (19 mm) CP Bak-Chek® Screwdriver Stop
17.	3308853	H-541-ASD	Control Stop Repair Kit †
	3308856	H-543-ASD	Control Stop Repair Kit †
18.	0308612	H-622	CP Bonnet †
	0308843	H-577	CP Bonnet † – DISCONTINUED
19.	3308772	H-1010-A	Vandal Resistant Control Stop Cap Assembly †
	3308790	H-1009-A	Vandal Resistant Control Stop Cap Assembly † H-600 3/4" Stop only
20.	0308738	H-573	Control Stop Cap CP †
	0308848	H-582	Control Stop Cap CP †
21.	3308866	H-574	Control Stop Cap with Bumper † (-YO Variation)
22.	3308867	H-576	Control Stop Cap with Extended Bumper † (-YG Variation)

* See pages 100-101 for additional lengths.

† For use with 1" and 3/4" H-700-A and 1" H-600-A Bak-Chek® screwdriver control stop

‡ For use with 3/4" H-600-A Bak-Chek® screwdriver control stop

Sloan products are also available in satin, brushed nickel, chrome, gilt and polished brass finishes – contact factory for part numbers.

ITEM 10A. SLIP JOINT GASKETS AND RINGS

Size	Code No.	Part No.	Description
1-1/2"	5306058	F-3	Red Friction Ring
	5322001	VBF-5	Black Slip Joint Gasket
	0319086/5319086	S-30	Flexible Seat
	0319079	S-21	Rigid Seat (rubber over brass)
1-1/2" x 1-1/4"	0396062	F-105	Slip Joint Gasket – Rigid
1-1/4"	5306057	F-3	Red Friction Ring
	5322176	VBF-5	Black Slip Joint Gasket
	0307052/5307052	G-21	Rigid Seat (rubber over brass)
1"	5306056	F-3	Red Friction Ring
	5306115	F-5	Black Slip Joint Gasket
3/4"	5306055	F-3	Red Friction Ring
	5306113	F-5	Black Slip Joint Gasket

This information contained in this document is subject to change without notice.

ROYAL FLUSHOMETER

DUAL FILTERED DIAPHRAGM ASSEMBLY

Available in diaphragm only and Royal® Performance™ Kits.

Royal® Performance™ Kit includes dual filtered diaphragm assembly (item 3), handle repair kit with triple seal packing (item 8), high back pressure vacuum breaker repair kit (item 11), and one tailpiece O-ring (item 15A). DIAPHRAGM ONLY KIT contains "drop-in" dual filtered diaphragm assembly (item 3) ONLY.

The dual filtered diaphragm can be used in Royal®, Regal®, and similar diaphragm-style valve bodies. For use in Sloan valve bodies with a bell-shaped cover (manufactured before 1964), replace the bottom filter ring in these kits with a blue A-108 filter ring (not shown Sloan Code No. 5301283).

NOTE: In January 1998, the Royal® diaphragm design was upgraded to a preassembled unit with two (2) plastic filtering rings attached to the rubber diaphragm (one on top and one on bottom). If the flushometer you are servicing has our older, segmented diaphragm with brass by-pass hole, refer to our Regal section for additional troubleshooting information.

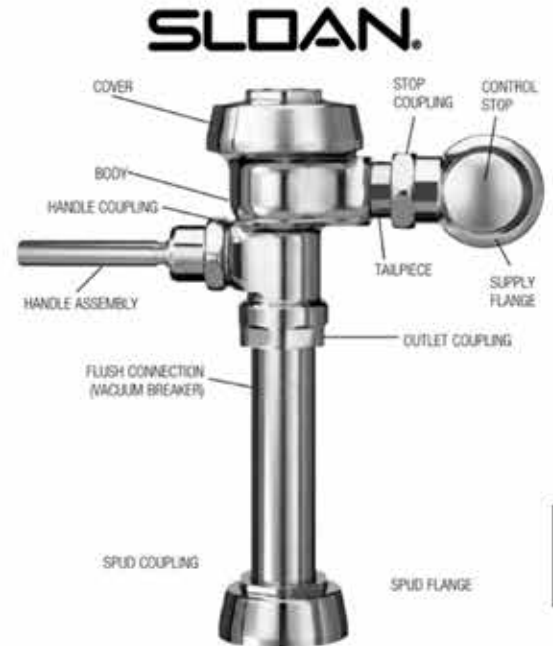

ROYAL® PERFORMANCE KIT

Code No.	Part No.	Description	Relief Valve [†]	Refill Head [*]	Flow Ring
3301070	A-1101-A	Low Consumption Water Closets-1.6 gpf (6.0 Lpf)**	Green	Gray	Smooth
3301071	A-1102-A	Water Saver Water Closets-3.5 gpf (13.2 Lpf)**	White	Gray	Smooth
3301072	A-1103-A	9 Liter European Water Closets-2.4 gpf (9.0 Lpf)	Blue	Gray	Smooth
3301073	A-1106-A	Wash Down Urinals-0.5 gpf (1.9 Lpf)	Green	Black	Smooth
3301074	A-1107-A	Low Consumption Urinals-1.0 gpf (3.8 Lpf)**	Green	Black	Slotted
3301075	A-1108-A	Water Saver Urinals-1.5 gpf (5.7 Lpf)**	Black	Black	Smooth

*Closet refill heads (gray) have larger slots than urinal refill heads (black).

DIAPHRAGM ONLY KIT

Code No.	Part No.	Description	Relief Valve [†]	Refill Head [*]	Flow Ring
3301502	A-1041-A	Low Consumption Water Closets-1.6 gpf (6.0 Lpf)**	Green	Gray	Smooth
3301501	A-1038-A	Water Saver Water Closets-3.5 gpf (13.2 Lpf)**	White	Gray	Smooth
3301505	A-1044-A	9 Liter European Water Closets-2.4 gpf (9.0 Lpf)	Blue	Gray	Smooth
3301504	A-1043-A	Wash Down Urinals-0.5 gpf (1.9 Lpf)	Green	Black	Smooth
3301503	A-1042-A	Low Consumption Urinals-1.0 gpf (3.8 Lpf)**	Green	Black	Slotted
3301500	A-1037-A	Water Saver Urinals-1.5 gpf (5.7 Lpf)**	Black	Black	Smooth
3301506	A-1045-A	High-Efficiency Water Closets-1.28 gpf (4.8 Lpf)	Blue	Gray	Smooth
3301142	A-1047-A	High-Efficiency Urinals-0.25 gpf (1.0 Lpf) with White Inserts	White	HEU Black	Smooth
3301143	A-1050-A	High-Efficiency Urinals-0.125 gpf (0.5 Lpf) with White Inserts	Blue	HEU Black	Smooth

† Consult factory for availability of replacement plastic relief valves (green, black, blue, and white) and brass relief valves.

NOTE: For older water closets that require 4.5 gpf (17.0 Lpf), choose kits A-1102-A or A-1038-A, but remove the flow ring before use. For blowout-style urinals that require 3.5 gpf (13.2 Lpf), choose kits A-1102-A or A-1038-A. For service sinks that require 6.5 gpf (24.6 Lpf), order A-36-A diaphragm repair kit (not shown Sloan Code No. 3301036) and remove the flow ring before use. Regulations for low consumption fixtures prohibit the use of higher flush volumes.

*Closet refill heads (gray) have larger slots than urinal refill heads (black).

** Water Saver (3.5 gpf closet and 1.5 gpf urinal) and Low Consumption (1.6 gpf closet and 1.0 gpf urinal) fixtures must use matching gpf (Lpf) diaphragm kits; using a smaller gpf (Lpf) kit in fixtures not intended for less volume will result in inadequate dilution in urinals and improper evacuation in closets.



SLOAN FLUSHOMETERS REGAL maintenance guide

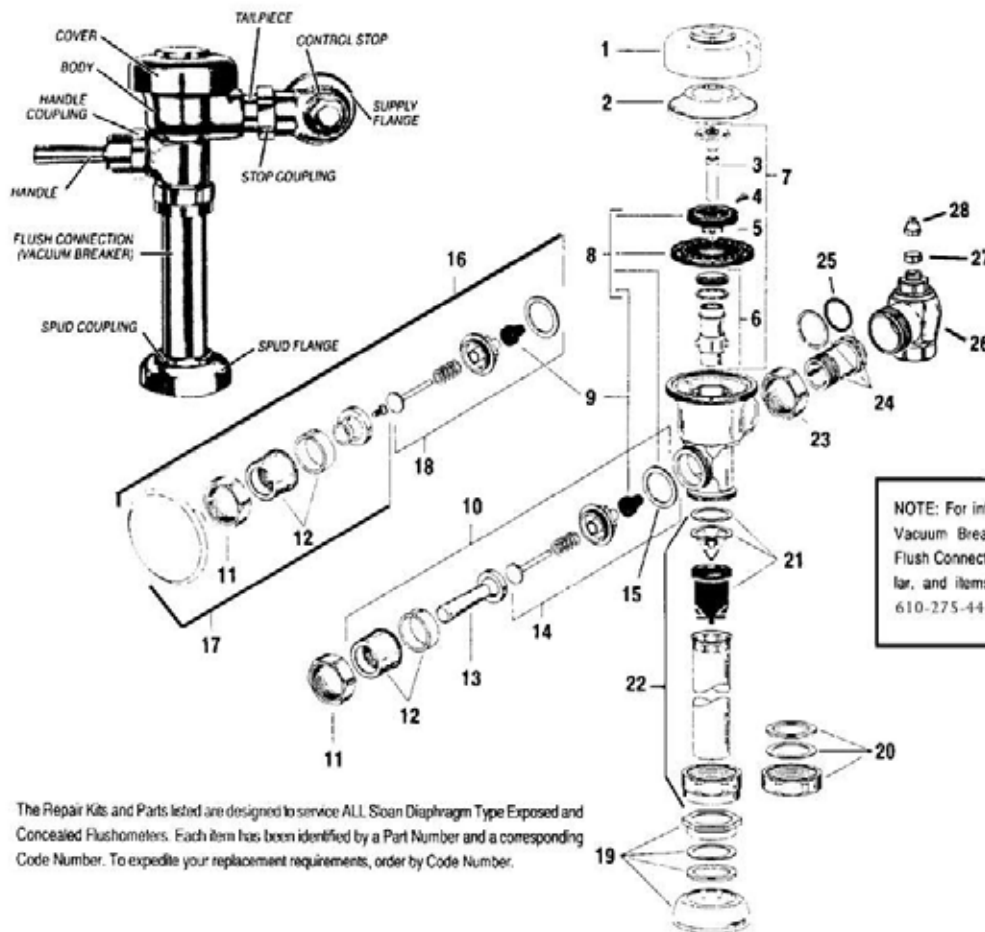

NOTE: For information on V-500-A, V-500-AA Vacuum Breakers, Exposed and Concealed Flush Connections, Tailpieces longer than regular, and items not shown call DUFF CO at 610-275-4453.

The Repair Kits and Parts listed are designed to service ALL Sloan Diaphragm Type Exposed and Concealed Flushometers. Each item has been identified by a Part Number and a corresponding Code Number. To expedite your replacement requirements, order by Code Number.

PARTS LIST

1.	0317004	R-10	CP Cover*	17.	3303347	C-1000-A	3" CP Push Button Replacement Kit
2.	0301168	A-71	Inside Cover	18.	3303396	C-64-A	3" Push Button Repair Kit
3.	5301058	A-19-AC	Relief Valve, White(Closet) - 12 per pkg.	19.	0306145	F-56-A	1 1/2" CP Spud Coupling
	5301059	A-19-AU	Relief Valve, Black (Urinal) - 12 per pkg.		0306142	F-55-A	1 1/4" CP Spud Coupling
4.	5301111	A-15-A	Disc - 12 per pkg.		0306102	F-54-A	3/4" CP Spud Coupling
5.	5301188	A-156-A	Diaphragm - 12 per pkg.	20.	0306093	F-2-A	1 1/2" CP Outlet Coupling Assembly*
6.	5301236	A-163-A	Guide - 12 per pkg.	21.	3323192	V-551-A	Vacuum Breaker Repair Kit
	5301031	A-151-A	Guide (1.6 GPF) Low Consumption Closets - 12 per pkg.	22.	5323005	V-500-AA	3/4" x 9" Vacuum Breaker
7.	3301036	A-36-A	Inside Parts Kit (1 1/2 GPF) Standard Closets /Service Sinks		5323006	V-500-AA	1 1/4" x 9" Vacuum Breaker
	3301037	A-37-A	Inside Parts Kit (1 1/2 GPF) Washdown/Water Saver Urinals		5323007	V-500-AA	1 1/2" x 9" Vacuum Breaker
	3301038	A-38-A	Inside Parts Kit (3 1/2 GPF) Water Saver Closets/3 gal. Urinals	23.	0308676	H-550	CP Stop Coupling*
	3301041	A-41-A	Inside Parts Kit (1.6 GPF) for Low Consumption Closets	24.	0308801	H-551-A	CP Adjustable Tailpiece 2 1/16" long*
	3301042	A-42-A	Inside Parts Kit (1 GPF) for Low Consumption Urinals	25.	5308696	H-533	"O"Ring - 24 per pkg.
8.	5301189	A-156-AA	Closet/Urinal Washer Set - 6 per pkg.	26.	0308704	H-540-A	1" Screwdriver Bak-Chek CP Control Stop
9.	5302297	B-39	Seal - 12 per pkg.		3308853	H-541-A	1" Screwdriver Bak-Chek Repair Kit
10.	5302279	B-32-A	CP Handle Assembly - 6 per pkg.		0308727	H-540-A	3/4" Screwdriver Bak-Chek CP Control Stop
	0302390	B-73-A	CP Handicapp Handle Assembly		3308856	H-543-A	3/4" Screwdriver Bak-Chek Repair Kit
11.	0301082	A-6	CP Handle Coupling*	27.	5308156	H-37	CP Cap - 6 per pkg.
12.	0302109	B-7-A	CP Socket	28.	5310034	J-2/J-7	Bumper Assembly - 12 per pkg.
13.	5302274	B-32	CP Grip - 12 per pkg.				
14.	5302305	B-50-A	Handle Repair Kit - 6 per pkg.				
15.	5301139	A-31	Handle Gasket - 48 per pkg.				
16.	0303351	C-42-A	3" CP Push Button Assembly				

CALL US NOW FOR YOUR SPECIAL PRICING!

SLOAN FLUSHOMETER TAILPIECES



THE TAILPIECE

The Tailpiece is the connection between the Valve Body and the Control Stop. Sloan Adjustable and Ground Joint Tailpieces are threaded into the Valve Body at the factory. Sloan Tailpieces are available in a variety of lengths to accommodate installation rough-in errors and unique installation requirements.

SLOAN FLUSHOMETER BRANDS FEATURE THREE TYPES OF TAILPIECE CONNECTIONS:

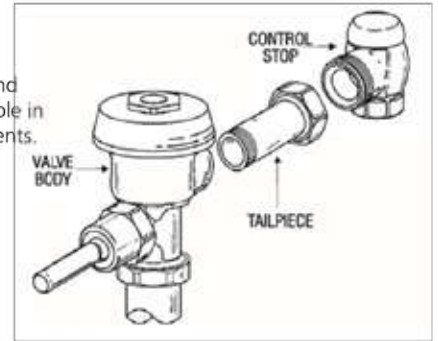

**H-530 TAILPIECE REMOVAL BAR
0334014**

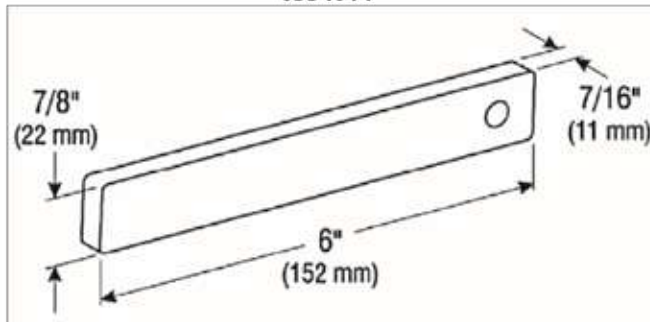

H-5 GROUND JOINT TAILPIECE CONNECTION

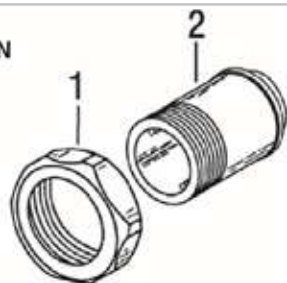

H-551-A ADJUSTABLE TAILPIECE CONNECTION

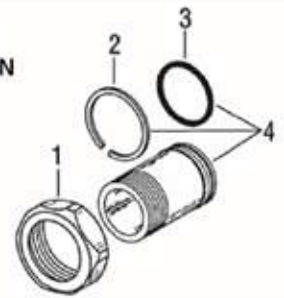

PART NO.	CODE		
1 H-550	0308676	Coupling	CP
	0308690	Coupling	RB
2 H-552	5308381	Locking Ring	(package of 12)
3 H-553	5308696	O-Ring	(package of 24)
4 H-551-A	0308801	2-1/16" (53 mm)	Tailpiece Assembly† CP
	0308802	2-1/16" (53 mm)	Tailpiece Assembly† RB
	0308803	3-1/16" (78 mm)	Tailpiece Assembly† CP
	0308805	4-1/16" (103 mm)	Tailpiece Assembly† CP
	0308807	5-1/16" (129 mm)	Tailpiece Assembly† CP
	0308809	6-1/16" (154 mm)	Tailpiece Assembly† CP

† Each Tailpiece Assy includes H-553 O-Ring & H-552 Lock Ring.
Abbreviations: CP: Chrome Plated; RB: Rough Brass

Chrome Plated Components

1	H-6	0308063	Coupling
2	H-5	See chart ↓	Ground Joint Tailpiece

"X"	Tailpiece Length	Code Number
4-1/4" (108 mm)	1-1/4" (32 mm)	0308019
4-1/2" (114 mm)	1-1/2" (38 mm)	0308023
4-3/4" (121 mm)	1-3/4" (44 mm)	0308026
5" (127 mm)	2" (51 mm)	0308030
5-1/4" (133 mm)	2-1/4" (57 mm)	0308031
5-1/2" (140 mm)	2-1/2" (64 mm)	0308033
5-3/4" (146 mm)	2-3/4" (70 mm)	0308034
6" (152 mm)	3" (76 mm)	0308035
6-1/4" (159 mm)	3-1/4" (83 mm)	0308037
6-1/2" (165 mm)	3-1/2" (89 mm)	0308038
6-3/4" (171 mm)	3-3/4" (95 mm)	0308040
7" (178 mm)	4" (102 mm)	0308041
7-1/4" (184 mm)	4-1/4" (108 mm)	0308042
7-1/2" (191 mm)	4-1/2" (114 mm)	0308043
7-3/4" (197 mm)	4-3/4" (121 mm)	0308044
8" (203 mm)	5" (127 mm)	0308045
8-1/2" (216 mm)	5-1/2" (140 mm)	0308047
9" (229 mm)	6" (152 mm)	0308050

H-130-A ADJUSTABLE GROUND JOINT TAILPIECE CONNECTION

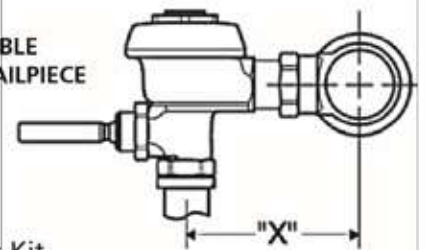

Tailpiece Retrofit Kit
(when used with Ground Joint Supply Stop)

Part Number	Code Number	"X"†
H-130-A-1†	0308976	4-3/4" (121 mm)
H-130-A-2	0308983	5-3/4" (146 mm)
H-130-A-3	0308984	6-3/4" (171 mm)
H-130-A-4	0308979	7-3/4" (197 mm)

† When used with a Sloan Ground Joint Supply Stop, the Tailpiece can be adjusted to a shorter or longer length (± 1/2" or 12 mm from the "X" dimension shown). When used with Delany Ground Joint Supply Stop, the Tailpiece can be adjusted up to 1" (25 mm) longer from the "X" dimension shown.

SLOAN BEDPAN WASHER REPAIR KIT

SLOAN

FLUSHOMETERS

slimline[®]
Bedpan Washer
Maintenance Guide



**BEDPAN
RETROFIT KIT**

FIG NO.

184908

See Royal Flushometer Troubleshooting and Maintenance Guide for ALL Valve Kits and Components.

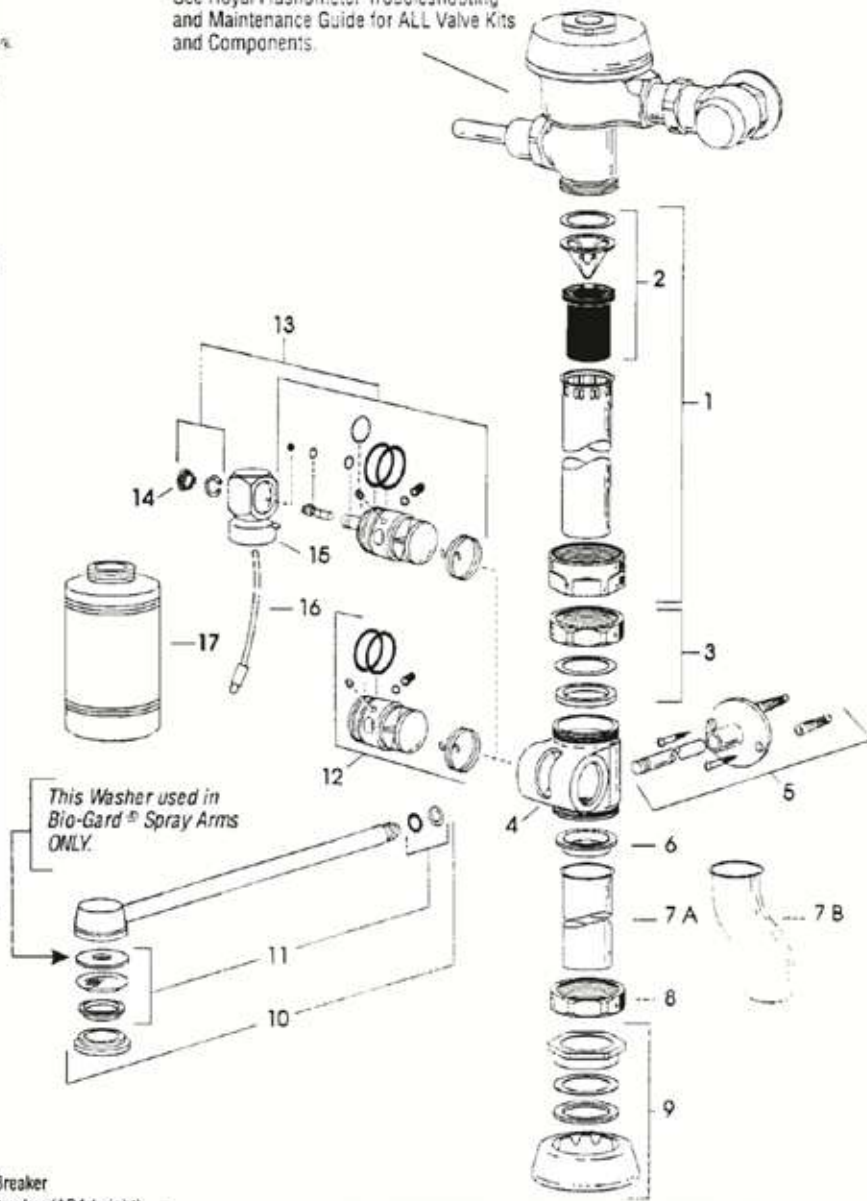

PARTS LIST

1.	0393009	V-600-AA	1 1/2" X 21 1/2" Vacuum Breaker
	0393008	V-600-AA	1 1/2" x 13 1/2" Vacuum Breaker (ADA height)
	0393029	V-600-AA	1 1/2" x 21 1/2" Vacuum Breaker w/2" Offset
2.	3323182	V-651-A	Vacuum Breaker Repair Kit
3.	0306093	F-2-A	1 1/2" Slip Joint Coupling
4.	0309001	DV-1	Diverter Valve Body
5.	3309035	DV-1001-A	Wall Support Kit
6.	0309027	F-1003	Outlet Tube Gasket
7A.	0309029	F-1005	Outlet Tube
7B.	0396525	F-182	Outlet Tube w/1 1/2" Offset
8.	0306045	F-2	1 1/2" Coupling Nut
9.	0306146	F-5-A	1 1/2" Spud Coupling Assembly
10.	3309044	DV-32-AA	Spray Arm Replacement Kit
	3309016	DV-1013-A	Bio-Gard Spray Arm Replacement Kit
	3309077	DV-1014-A	Short Spray Arm Replacement Kit (for use w/F-182 Offset Outlet Tube)
11.	3309032	DV-1007-A	Spray Arm Repair Kit
12.	3309037	DV-1003-A	Pivot Replacement Kit
13.	3309036	DV-1002-A	Deoseptic Pivot Replacement Kit
14.	0309024	DV-21	Plug Button
15.	0309033	DV-33-A	Swivel & Ball Check Assembly
16.	0309036	DV-36-A	Aspirator Tube Assembly
17.	0309018	DV-29	Deoseptic Solution Bottle

BEDPAN WASHER REBUILD KITS

CODE #	KIT #	DESCRIPTION
5309031	DV-50-A	DIVERTER REBUILD KIT Includes outlet tube gasket (item 6), spray arm repair kit (item 11), and all items in pivot replacement kit (item 12) except pivot.
3309040	DV-1004-A	DEOSEPTIC DIVERTER REBUILD KIT Includes outlet tube gasket (item 6), spray arm repair kit (item 11), and all items in pivot replacement kit (item 13) except pivot.

To convert a standard diverter assembly to a deoseptic diverter assembly use:

3309048 DV-1005-A DEOSEPTIC CONVERSION KIT

PARTS LIST FOR SERIES 900® CONCEALED FLUSHOMETER

Item No.	Code No.	Part No.	Description
1.	0301173	A-72	RB Royal® Cover
2.	0301168	A-71	Inside Cover
3.	SEE DIAPHRAGM CHART		
4.	3323182	V-651-A	Vacuum Breaker Repair Kit
5.	0308690	H-550	RB Tailpiece Coupling
6.	0308802	H-551-A	RB Adjustable Tailpiece, 2-1/16" (52 mm)
7A.	5308696	H-553	O-ring – 24 per package
7B.	5308381	H-552	Locking ring – 12 per package
8.	0388010	H-730-A	RB Wheel Handle Bak-Chek® Control Stop
9A.	3308855	H-541-A	1" Wheel Handle Repair Kit for H-730-A Control Stop
9B.	3308858	H-543-A	3/4" Wheel Handle Repair Kit for H-730-A Control Stop
10.	0308919	H-558-A	Wheel Handle
11A.	0308615	H-623	1" RB Bonnet
11B.	0208083	H-623	3/4" RB Bonnet
12.	See page 111	V-600-AA	Royal Vacuum Breaker Flush Connection (specify length and size)
13.	0306619	F-2-AA	1-1/2" (38 mm) RB Couplings (2 each), Friction Rings (2 each), and Rubber Gaskets (2 each)
14.	0206146	F-21	RB Elbow
15.	0306091	F-2-A	1-1/2" (38 mm) RB Coupling and S-21 Flat Rigid Gasket
16.	See pages 111-116	F-100	RB Flared End Flush Connection (specify length)
17.	See pages 111-116	F-15-A	3/4" (19 mm) RB Elbow Flush Connection with Coupling and Rubber Gasket (specify length)
18.	0306054	F-2-A	3/4" (19 mm) RB Coupling, Friction Ring, and Rubber Gasket
19.	0318024	HY-25	RB Valve Actuator Housing only
20.	0318023	HY-24	Tube Fitting (2 required)
21.	0318033	HY-35	Tube Fitting Nut (2 required)
22.	0318093	HY-30	1/4" (6 mm) x 48" (1219 mm) Connecting Tubes (2 required)
23.	0301082	A-6	RB Handle Coupling Nut
24.	3318005	HY-109-A	Actuator Housing Assembly (includes Item 19, 20, 21, 23 and 26)
25.	3318001	HY-83-A	Actuator Cartridge Assembly
26.	0337086	DO-22	O-ring for HY-109-A Adapter
27.	SEE SLIP JOINT GASKETS AND RINGS TABLE BELOW		
28.	0301050	A143-A	RB Valve Body

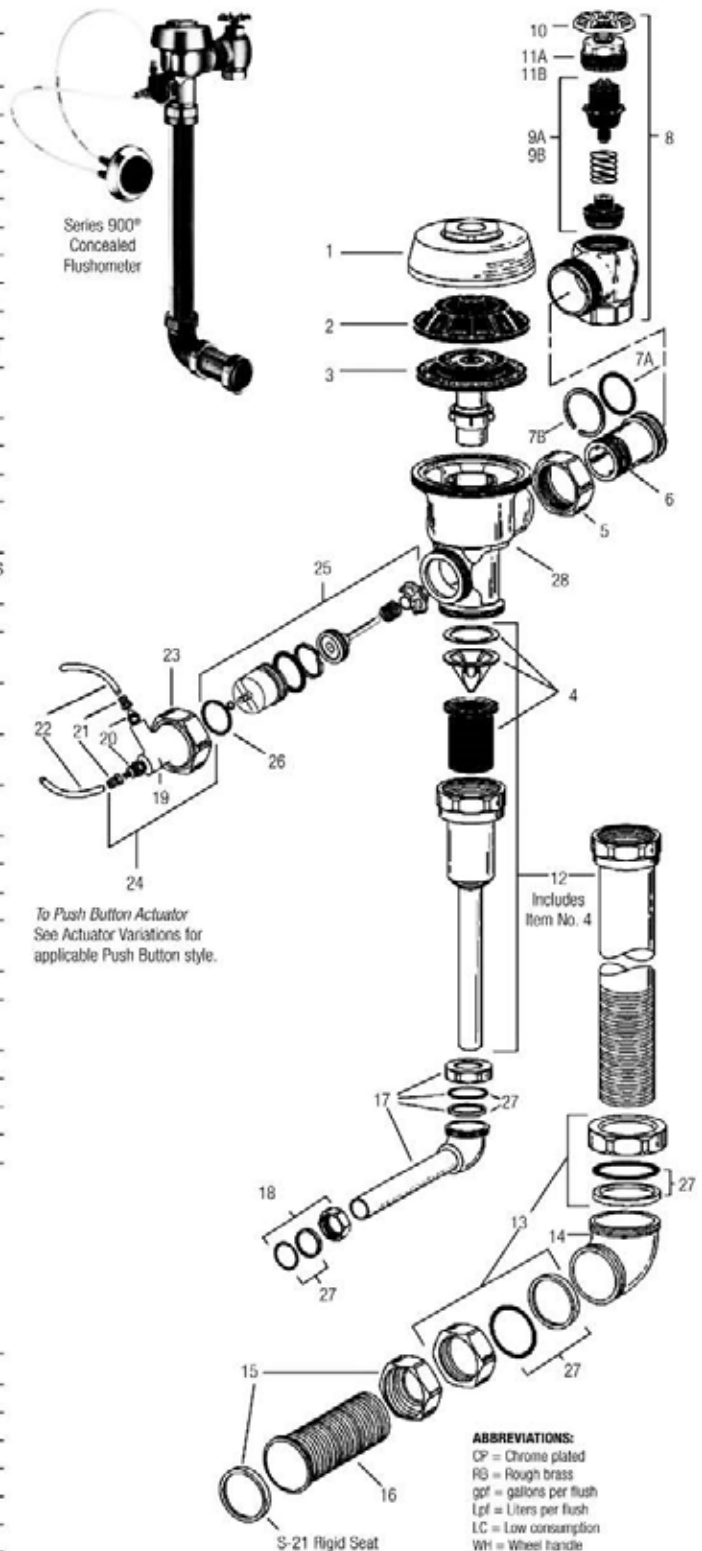

ITEM 27. SLIP JOINT GASKETS AND RINGS

Size	Code No.	Part No.	Description
1-1/2"	5306058	F-3	Red Friction Ring
	5322001	VBF-5	Black Slip Joint Gasket
	0319086/5319086	S-30	Flexible Seat
	0319079	S-21	Rigid Seat (rubber over brass)
1-1/2" x 1-1/4"	0396062	F-105	Slip Joint Gasket – Rigid
1-1/4"	5306057	F-3	Red Friction Ring
	5322176	VBF-5	Black Slip Joint Gasket
	0307052/5307052	G-21	Rigid Seat (rubber over brass)
1"	5306056	F-3	Red Friction Ring
	5306115	F-5	Black Slip Joint Gasket
3/4"	5306055	F-3	Red Friction Ring
	5306113	F-5	Black Slip Joint Gasket

TAILPIECES, CONTROL STOPS, PUSH BUTTONS AND FLUSH CONNECTIONS

For additional information on tailpieces, control stops, push buttons and flush connections see Showerheads, Parts and Accessories Tab.

HY-49-A (0318049) METAL PARTITION PUSH BUTTON

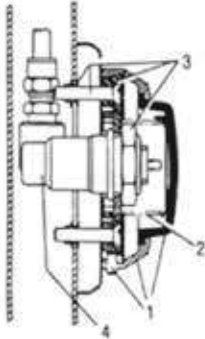

Item			
No.	Code No.	Part No.	Description
1.	3318007	HY-1000-A	Push Button Kit – includes Push Button, Flange, Spring & Set Screw
2.	0318004	HY-3	Spring
3.	3318010	HY-1003-A	Mounting Flange Kit – includes Mounting Flange, Mounting Nut, Screws (2) & Tinnerman Nuts (2)
4.	0318123	HY-71-A	Actuator Assembly

NOTE: Includes HY-32-A cartridge (shown at right)
NOTE: Maximum distance from button to valve is 20' (longer tubing required)

HY-72-A (0318072) SIDE WALL PUSH BUTTON

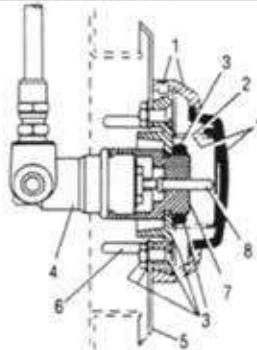

Item			
No.	Code No.	Part No.	Description
1.	3318007	HY-1000-A	Push Button Kit – includes Push Button, Flange, Spring & Set Screw
2.	0318004	HY-3	Spring
3.	3318008	HY-1001-A	Mounting Flange Kit – includes Mounting Flange, Mounting Nut, Screws (2), Nuts (2) & Washers (2)
4.	0318123	HY-71-A	Actuator Assembly
5.	0318041	HY-40	Plate
6.	0305173	EL-173	Screws (4)
7.	0318073	HY-73	Extension Adapter
8.	0318074	HY-74	Extension Stem

NOTE: Includes HY-32-A cartridge (shown at right)
NOTE: Maximum distance from button to valve is 20' (longer tubing required)

HY-108-A (0318119) PENAL WARE METAL PUSH BUTTON

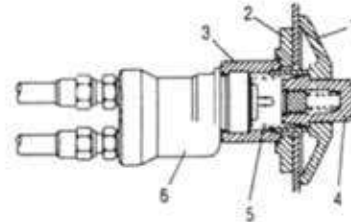

Item			
No.	Code No.	Part No.	Description
1.	0318116	HY-91	Flange
2.	0318111	HY-94	Mounting Washer
3.	0318112	HY-93	Mounting Nut
4.	0318115	HY-86-A	Push Button Assembly
5.	0305134	EL-109	Spring
6.	0318078	HY-50-A	Actuator Assembly

NOTE: Includes HY-32-A cartridge (shown below)
NOTE: Maximum distance from button to valve is 20' (longer tubing required)

HY-32-A ACTUATOR CARTRIDGE ASSEMBLY



For use with HY-50-A and HY-71-A actuator assemblies

HY-100-A (0318117) FIXTURE WALL METAL PUSH BUTTON

Item			
No.	Code No.	Part No.	Description
1.	0318117	HY-100-A	Fixture Wall Metal Button Assembly
2.	3318006	HY-111-A	Metal Button Kit
3.	0305134	EL-109	Spring
4.	0318078	HY-50-A	Actuator Assembly
5.	0318033	HY-35	Tube Fitting Nut (2 required)
6.	0318028	HY-29	Threaded Rod
7.	0318109	HY-105	Spacer
8.	3318009	HY-1002-A	Mounting Strap Kit

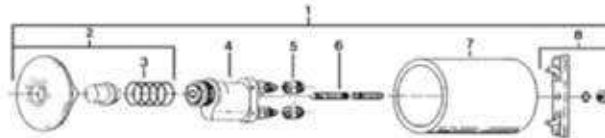

HY-33-A (0318001) FIXTURE WALL PUSH BUTTON

1.	0318001	HY-33-A	Fixture Wall Push Button Assembly
2.	3318007	HY-1000-A	Push Button Kit
3.	0318004	HY-3	Spring
4.	3318008	HY-1001-A	Mounting Flange Kit
5.	0318078	HY-50-A	Actuator Assembly
6.	0318033	HY-35	Tube Fitting Nut (2 required)
7.	0318028	HY-29	Threaded Rod
8.	0318109	HY-105	Spacer
9.	3318009	HY-1002-A	Mounting Strap Kit

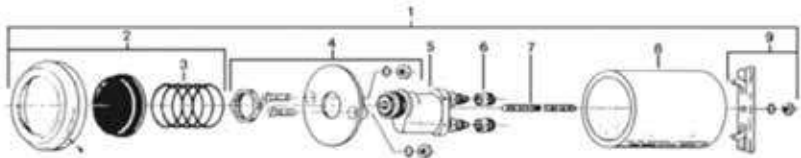

SLOAN REPAIR



SLOAN VACUUM BREAKER

DESCR	FIG. NO.	PRICE
V500A complete vacuum breaker repair kit	7263	
V551A repair kit	18001	

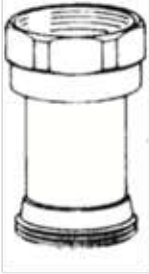

SLOAN VACUUM BREAKER V 600 KITS

DESCR	FIG. NO.	PRICE
3/4x9 CP Vac Brkr	38130	
1-1/4x9 CP Vac Brkr	7259	
1-1/4x21-1/2 CP Vac Brkr	44763	
1-1/2x9 CP Vac Brkr	7261	
1-1/2x13-1/2 CP Vac Brkr	44627	
1-1/2x24-1/2 CP Vac Brkr	38133	
V553A CP Cplg	38134	
V551A repair kit	18001	

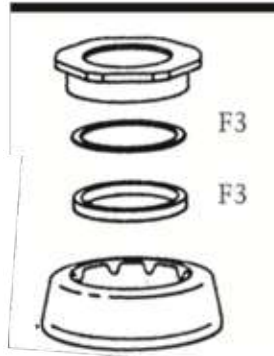

SPUD COUPLING ASSEMBLY

SIZE	FIG. NO.	PRICE
3/4"	7224	
1"	7225	
1 1/4"	7226	
1 1/2"	7228	

FRICTION RING ONLY

SIZE	FIG. NO.	PRICE
3/4"	28176	
1 1/4"	38114	
1 1/2"	38115	

SLIP JOINT GASKET ONLY

SIZE	FIG. NO.	PRICE
3/4"	24620	
1 1/4"	38128	
1 1/2"	38127	

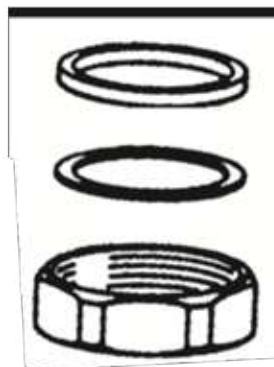

F2A COUPLING ASSEMBLY

SIZE	FIG. NO.	PRICE
3/4"	7216	
1 1/2"	7222	



SWEAT KIT

DESCR	FIG. NO.	PRICE
1"	7204	
3/4"	7206	

V-651-A High Back Pressure Vacuum Breaker Repair kit

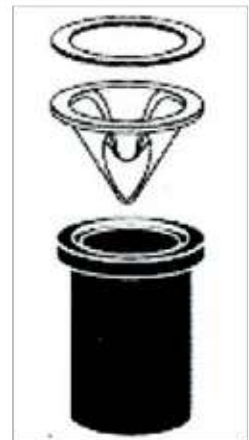

FIG. NO.
80026



All genuine SLOAN parts are available in bulk!

SLOAN REPAIRS

INTERNAL REPAIR KIT

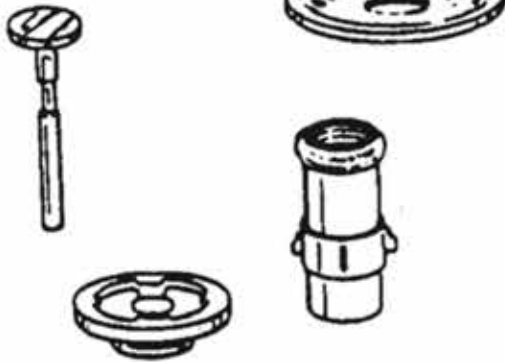

OEM	DESCR	FIG. NO.
A36A	Closet Kit 4.5 Gal	7273
A37A	Urinal Kit 1.5 Gal	7274
A38A	Closet Kit 3.5 Gal	7275
A41A	Closet Kit 1.6 Gal	50131
A42A	Urinal Kit 1.0 Gal	
A15A	Disc	7210
A156A	Diaphragm	7277
A156AA	Diaphragm Kit	38660
A163A	Guide	38661
A19AC	Closet Relief Valve 3.5 Gal	7207
A19AU	Urinal Relief Valve 1.5 Gal	38655

HANDLE REPAIR KIT

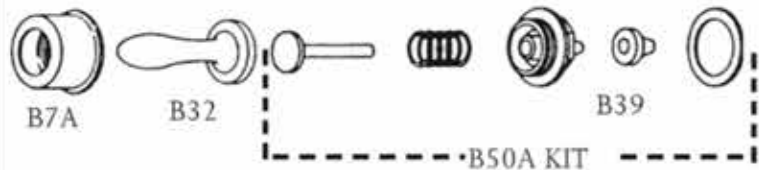

OEM	DESCR	FIG. NO.	PRICE
B32A	Kit	32820	
B50A	Kit	7282	
B32	Handle	38662	
B39	Seal	7280	
B7A	Socket	7214	

PEDAL PUSH BUTTON FOR EXPOSED ROYAL & CROWN HANDLE REPAIR KIT

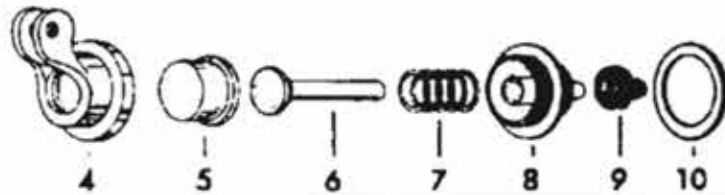

FIG. NO.	PRICE
7281	

CAPS FOR SLOAN - chrome plated



DESCR	FIG. NO.	PRICE
Replaces H582	7245	
Replaces H573	7244	

VANDAL PROOF CAP FOR SLOAN



SIZE	FIG. NO.	PRICE
3/4"	38948	
1"	38947	

STOP WASTING MONEY.
Call DUFF First!
610-275-4453



SLOAN INSIDE PLASTIC COVER (NEW STYLE)



DESCR	FIG. NO.	PRICE
A71	7212	
0306668		

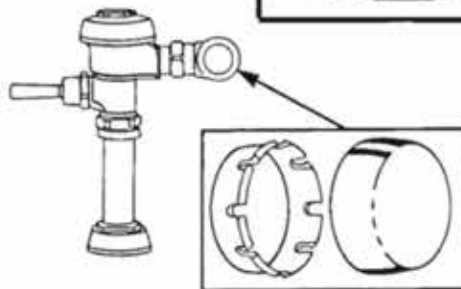

SLOAN VANDAL-RESISTANT CONTROL STOP CAP

New stop cap retrofits on your existing control stop (600 Series).

No-hex design gives you Sloan Flushometers a contemporary styling, while eliminating the flats and leverage of the old design.

All-metal new control stop cap installs quick and easy. After installation, it spins freely, further helping to eliminate leverage and vandalism.

Brass construction provides long life and durability while protecting the screwdriver slotted regulating stem from unauthorized tampering.

SIZE	OEM FIG.	NO.	PRICE
3/4"	H-1009-A	78881	
1"	H-1010-A	78882	

SLOAN CONTROL STOPS AND KITS

**H-700 Stop, chrome plated:
Screwdriver Angle Stop with
H-1010-A Vandal Resistant Cap**

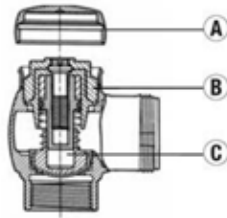

Code No.	Part No.	Description
COMPLETE STOPS		
3308384	H-700-A	3/4" NPTF inlet for adjustable tail
3308386	H-700-A	1" NPTF inlet for adjustable tail
3308385	H-700-AG	3/4" NPTF inlet for ground joint tail
3308387	H-700-AG	1" NPTF inlet for ground joint tail
3308388	H-700-AW	1" Whitworth inlet for adjustable tail
REPAIR PARTS		
3308772	A H-1010-A	Vandal Resistant Cap*, chrome plated
0308612	B H-622	Bonnet, chrome plated
3308853	C H-541-ASD	Control Stop Repair Kit*

**H-730 Stop, rough brass:
Concealed Wheel Handle
Angle Stop**

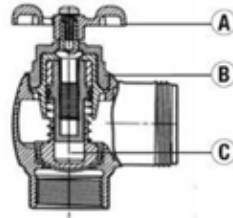

Code No.	Part No.	Description
COMPLETE STOPS		
0388011	H-730-A	3/4" NPTF inlet for adjustable tail
0388010	H-730-A	1" NPTF inlet for adjustable tail
0388014	H-730-AG	3/4" NPTF inlet for ground joint tail
0388013	H-730-AG	1" NPTF inlet for ground joint tail
0388012	H-730-AW	1" Whitworth inlet for adjustable tail
0388056	NH-730-AG	3/4" NPTF inlet for ground joint tail (Naval brass)
0388017	NH-730-AG	1" NPTF inlet for ground joint tail (Naval brass)
0388041	NH-730-AW	1" Whitworth inlet for adjustable tail (Naval brass)
0388046	NH-730-AGW	1" Whitworth inlet for ground joint tail (Naval brass)
REPAIR PARTS		
3308872	A H-1011-A	Concealed Wheel Handle Repair Kit*
0208083	B H-623	Bonnet, rough brass
3308860	C H-1006-A	Control Stop Repair Kit*

**H-735 Stop, chrome plated:
Exposed Wheel Handle
Angle Stop**

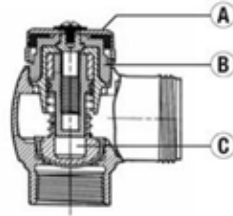

Code No.	Part No.	Description
COMPLETE STOPS		
0388007	H-735-A	3/4" NPTF inlet for adjustable tail
0388006	H-735-A	1" NPTF inlet for adjustable tail
0388009	H-735-AG	3/4" NPTF inlet for ground joint tail
0388008	H-735-AG	1" NPTF inlet for ground joint tail
REPAIR PARTS		
3308060	A H-1002-A	Exposed Wheel Handle Repair Kit*
0308615	B H-623	Bonnet, chrome plated
3308855	C H-541-AWH	Control Stop Repair Kit*

**H-750 Stop, chrome plated:
Screwdriver Straight Stop with
H-1010-A Vandal Resistant Cap**

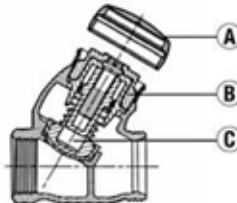

Code No.	Part No.	Description
COMPLETE STOPS		
3308389	H-750-AG	1" NPTF inlet for ground joint tail
REPAIR PARTS		
3308772	A H-1010-A	Vandal Resistant Cap*, chrome plated
0308612	B H-622	Bonnet, chrome plated
3308853	C H-541-ASD	Control Stop Repair Kit*

**H-750 Stop, chrome plated:
Screwdriver Straight Stop with
H-1010-A Vandal Resistant Cap**

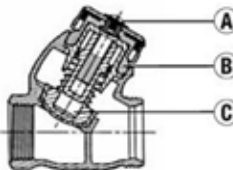

Code No.	Part No.	Description
COMPLETE STOPS		
3308389	H-750-AG	1" NPTF inlet for ground joint tail
REPAIR PARTS		
3308772	A H-1010-A	Vandal Resistant Cap*, chrome plated
0308612	B H-622	Bonnet, chrome plated
3308853	C H-541-ASD	Control Stop Repair Kit*

**H-750 Stop, chrome plated:
Screwdriver Straight Stop with
H-1010-A Vandal Resistant Cap**

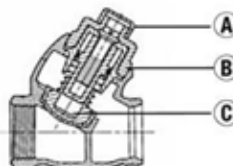

Code No.	Part No.	Description
COMPLETE STOPS		
3308389	H-750-AG	1" NPTF inlet for ground joint tail
REPAIR PARTS		
3308772	A H-1010-A	Vandal Resistant Cap*, chrome plated
0308612	B H-622	Bonnet, chrome plated
3308853	C H-541-ASD	Control Stop Repair Kit*

ZURN ZR6000 AV AQUAVANTAGE

Part Identification

1. Handle Sleeve and Insert
2. Low Force/ADA Compliant Handle
3. Actuator Rod
4. Handle O-Ring
5. Handle Spring
6. Handle Retainer
7. Handle Seal
8. Gasket
9. Valve Body Cover
10. Plastic Cover
11. Trip Mechanism
12. Diaphragm Repair Kit
13. Valve Body
14. Vacuum Breaker Insert
15. Vacuum Breaker Duckbill
16. Vacuum Breaker Tube
17. Vacuum Breaker Tube Nut
18. Spud Nut
19. Spud Friction Washer
20. Spud Sleeve
21. Spud Escutcheon
22. Tailpiece
23. Snap Ring
24. Tailpiece O-Ring
25. Locking Nut
26. Setscrew for Cast Wall Flange
27. Cast Wall Escutcheon
28. Supply Cover Tube
29. Sweat Solder Adapter
30. Stop Body
31. Piston Seal
32. Piston
33. Stop Spring
34. Guide O-Ring
35. Piston Guide
36. Guide Holder
37. Adjusting Screw
38. Stop Cap
39. Snap Cap Screw Cover
40. Vandal-Resistant Control Stop Cover
41. Setscrew for Control Stop Cover

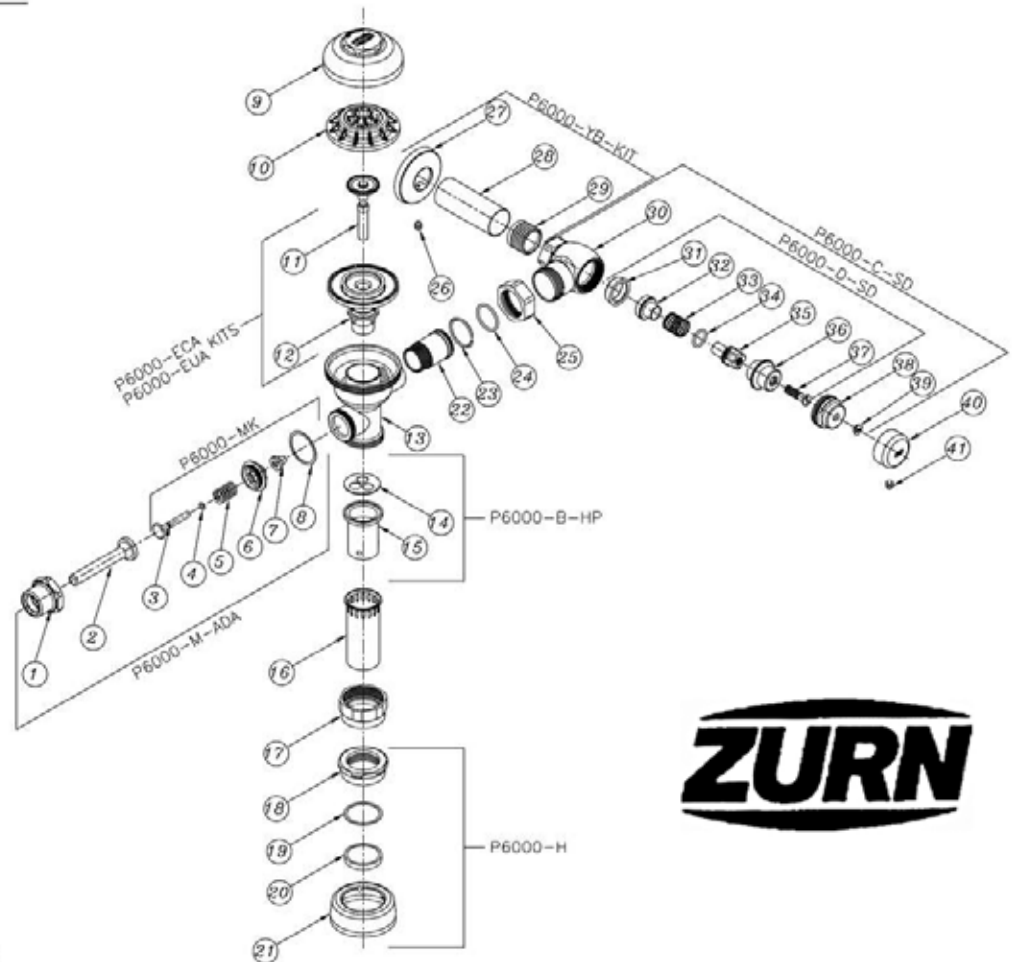

Covers and Repair Kits	Product No.
Outside Cover - CP - Item 9	P6000-LL
Inside Cover - Item 10	P6000-L
High Efficiency Toilet Closet Kit - 1.28 gal. flush	P6000-ECA-HET
Ultra Low Flow Urinal Kit - 0.125 gal. flush	P6000-EUA-ULF
Low Consumption Closet Kit - 1.6 gal. flush	P6000-ECA-WS1
Water Saving Closet Kit - 3.5 gal. flush	P6000-ECA-WS
Full Flow Closet Kit - 4.5 gal. flush	P6000-ECA-FF
Low Consumption Urinal Kit - 1.0 gal. flush	P6000-EUA-WS1
Water Saving Urinal Kit - 1.5 gal. flush	P6000-EUA-WS
Full Flow Urinal Kit - 3.0 gal. flush	P6000-EUA-FF
Repair Parts - Inside Parts	Product No.
Urinal Relief Valve - Item 11	P6000-EU13
Closet Relief Valve - Item 11	P6000-EC13
AquaVantage Rebuild Kits	Product No.
Closet and Urinal Rebuild Kits Include Items 3-8, 11, 12, 14, 15, 24 (Specify flow rate)	P6000-ECA-__RK
Handle Assembly and Repair Kits	Product No.
ADA Handle Assembly (Side) Includes Items 1-8	P6000-M-ADA
Handle Repair Kit (Side) Includes Items 3-8	P6000-MK
Handle Seal Includes Item 7	P6000-M9
Handle Gasket Includes Item 8	P6000-M10
Repair Kit for Front Operation - Exposed Includes Items 3-8	P6000-MHK
Handle Assembly (Front) Includes Items 1-8	P6000-MH

Control Stop Repair Kit and Parts	Product No.
Control Stop Repair Kit for 1" and 3/4", Includes Items 31-37	P6000-D-SD
Seal Seat for 1" and 3/4", Includes Item 31	P6000-D42
VP Control Stop Replacement for 1" and 3/4", Includes Items 30-39	P6000-C-SD
Sweat Solder Connection with Cast Wall Flange, Includes Items 26-29	P6000-YB
Adjustable Tailpieces	Product No.
Adjustable Tailpiece for Standard Flush Valve, Includes Items 22-24	P6000-J1
Tailpiece Coupling Assembly, Includes Items 23-25	P6000-K
Tailpiece Locking Ring, Includes Item 23	P6000-C30
Tailpiece O-Ring, Includes Item 24	P6000-C31
Coupling Nut, Includes Item 25	P6000-C32
Flush Connections and Spud Coupling Kits	Product No.
Flush Tube Assembly for Flush Valves, Includes Items 14-16. Specify diameter and length.	P6000-A-HP
Vacuum Breaker Repair Kit, Includes Items 14-15	P6000-B-HP
Spud Coupling Assembly, Includes Items 18-21. Specify size.	P6000-H

Covers

Outside Cover – Chrome Plated (11)
 Inside Cover (12)

Product No.

P-6000-LL
 P-6000-L

Replacement Kits

Closet Replacement Kit (14-18, 25, 26, 27)
 Water-Saving Closet Replacement Kit (14-18, 25, 26, 27)
 Low-Consumption Closet Replacement Kit (14-18, 25, 26, 27)
 Urinal Replacement Kit (14-18, 25, 26, 27)
 Water-Saving Urinal Replacement Kit (14-18, 25, 26, 27)
 Low-Consumption Urinal Replacement Kit (14-18, 25, 26, 27)

Product No.

PR-6000-EC
 PR-6000-EC-WS
 PR-6000-EC-WS1
 PR-6000-EU
 PR-6000-EU-WS
 PR-6000-EU-WS1

Replacement Parts – Inside Components

Riser Tube (13)
 Closet Volume Control - 4.5 GpF (25)
 Water-Saving Closet Volume Control - 3.5 GpF (25)
 Low-Consumption Closet Volume Control - 1.6 GpF (25)
 Urinal Volume Control - 3.0 GpF (25)
 Water-Saving Urinal Volume Control - 1.5 GpF (25)
 Low-Consumption Urinal Volume Control - 1.0 GpF (25)
 Diaphragm (15)

Product No.

PR-6000-E13F
 PR-6000-EC25
 PR-6000-EC25-WS
 PR-6000-EC25-WS1
 PR-6000-EU25
 PR-6000-EU25-WS
 PR-6000-EU25-WS1
 P-6000-E15

Sensor Module Replacement Kits

Solenoid Valve Replacement Kit (8, 9, 10)
 Sensor Lens Kit (6)
 High Volume Sensor (3, 4, 5, 6)
 Low Volume Sensor (3, 4, 5, 6)
 Battery Holder with Connecting Cable (1)
 Metal Housing (7)
 Metal Cover with Screw and Seals (20, 21, 22, 23)
 Vandal-Resistant Cover Wrench (24)

Product No.

PR-6000-M
 PR-6000-SC
 PR-6000-SH
 PR-6000-SL
 PR-6000-MB
 PR-6000-MH
 PR-6000-MC
 PR-6000-W

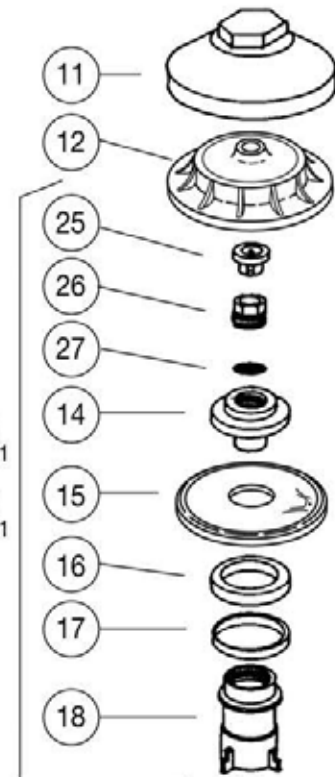

PR-6000-EC
 PR-6000-EC-WS
 PR-6000-EC-WS1
 PR-6000-EU
 PR-6000-EU-WS
 PR-6000-EU-WS1

PR-6000-E13F (13)



- | | |
|---|-------------------------------------|
| 1 Battery Holder and Battery Connecting Cable | 16 Flow Ring |
| 3 Sensor Screws - 2 | 17 Guide Ring |
| 4 Sensor Electronics | 18 Cylinder Slide |
| 5 Sensor Lens Screws - 2 | 19 Main Valve Body (with Tailpiece) |
| 6 Sensor Lens | 20 O-Ring |
| 7 Metal Housing | 21 Metal Housing Cover |
| 8 Solenoid Valve Retainer Clip | 22 O-Ring |
| 9 Solenoid Valve | 23 Cover Screw |
| 10 Gasket | 24 Cover Screw Wrench |
| 11 Main Valve Body Cover | 25 Volume Control |
| 12 Plastic Cover | 26 Filter Retainer |
| 13 Riser Tube | 27 Filter |
| 14 Diaphragm Disc | 28 Push-Button Assembly |
| 15 Diaphragm | |

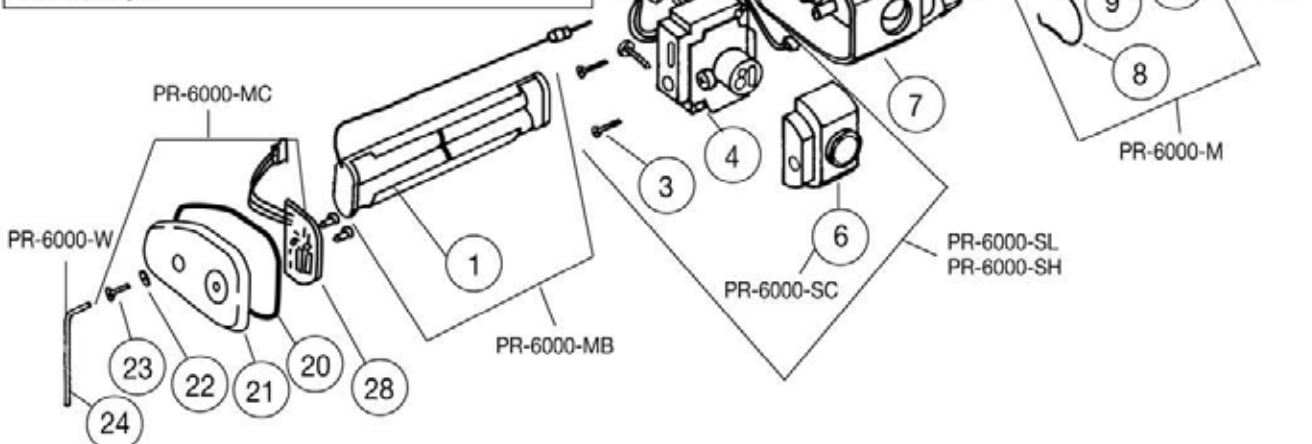

TOTO MANUAL TOILET FLUSH VALVE, EXPOSED - 1.6 GPF
NON-HOLD OPEN

Item	Part	Description
1	TH305SV118	Valve Cover Set (1.6 & 3.5 GPF)
2	TH305SV108	Screw Cap (MFV & Angle Stop)
3	TH305SV110	Adjustment Screws (Toilet)(10 Pieces)
4	TH305SV111	O-Rings (Cap Screw)(10 Pieces)
5	TH305SV112	O-Rings (Valve Guide)(10 Pieces)
6	TH323V100	Piston Valve Assembly (1.6 GPF)
7	TH305SV103	U-Packing (For Piston)(10 Pieces)
8	TH321	Seal Washer Kit
9	THYD9	Lever Assembly
10	THY326	Push Button Assembly
11	TH302RV100	Gaskets (U-Packing)(10 Pieces)
12	TH305SV104	Fiber Washers (10 Pieces)
13	TH305SV113	Nut
14	TH305SV105	Locking Rings (10 Pieces)
15	TH305SV114	Tail Piece
16	TH305SV106	O-Rings (Tail Piece)(10 Pieces)

Vacuum Breaker Sets

VB9CP-32 Exposed - Top Spud (1-1/2" Outlet)

Notes

For additional information, refer to the individual vacuum breaker parts sheets.

PRODUCT NUMBER EXPLANATIONS

- Flush Valve
- (T) Fitting
- (M) Manual
- (T) Toilet 1.6 Gpf
- (1) Exposed
- (N) Non-Hold Open
- (N) Neutral Rough-In
- (C) Chrome Finish
- (3) 1-1/2" Outlet
- (2) Top Spud

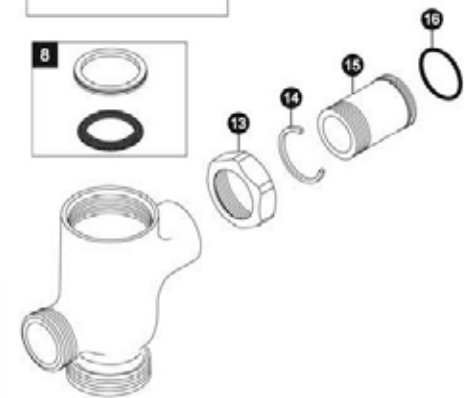
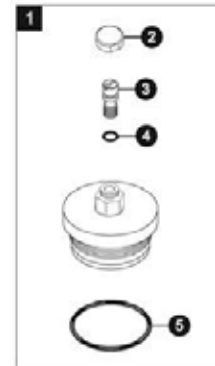
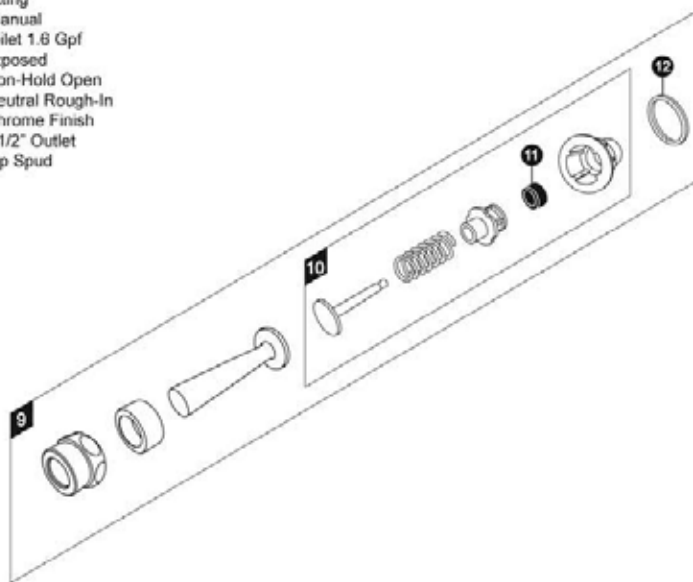

TOTO®

ECOPOWER SENSOR HIGH EFFICIENCY TOILET FLUSH VALVE EXPOSED - 1.28 GPF HYDRO-POWER CHARGE

Item	Part	Description
1	TH559EDV511	Top Cover
2	8HU5016	Vandal Resist Set Screw & Allen Wrench Kit
3	TH559EDV517	Clamp Set
4	TH559EDV515	Sensor Controller & Packing Set
5	TH559EDV516	Holder
6	TH559EDV514	Glass & Packing Set
7	THP3053	Back-Up Battery
8	TH559EDV518	Controller (Toilet)
9	TH559EDV513	M4 Screws (5 pieces)
10	TH559EDV512	Lower Cover Set
12	TH559EDV535	Valve Body For Exposed (Toilet 1.28GPF)
13	TH559EDV507	Valve Cap Assy (Toilet 1.6/1.28 GPF)
14	TH305SV111	O-Rings (Cap Screw)(10 Pieces)
15	TH305SV120	O-Rings (Valve Cap)(10 Pieces)
16	TH305SV112	O-Rings (Valve Guide)(10 Pieces)
17	TH323V103R	Piston Assembly (1.6/1.28 GPF)
18	TH305SV103	U-Packing (For Piston)(10 Pieces)
19	TH559EDV301	Double Sems Screws M3 (4 pieces)
20	TH559EDV510	Solenoid Unit & Diaphragm Assy
21	TH321	Seal Washer Kit

22	TH559EDV506	Manual Flushing Button
25	TH305SV113	Nut
26	TH305SV105	Locking Rings (10 Pieces)
27	TH305SV114	Tail Piece
28	TH305SV106	O-Rings (Tail Piece)(10 Pieces)
29	TH559EDV505	Double Sems Screws M3 (4 pieces)
30	TH559EDV503	Hydro-Power Generator (Toilet)
31	0EU5160	1.28 GPF Water Saving Sticker (English)
32	0EU3017	1.28 GPF Water Saving Sticker (Spanish)
33	0EU3015	1.28 GPF Water Saving Sticker (French)

PRODUCT NUMBER EXPLANATIONS

Flush Valve

- (T) Fitting
- (E) Electronic
- (T) Toilet 1.28 Gpf
- (1) Exposed
- (L) HET Dynamo (Hydro Generator)
- (N) Neutral Rough-In
- (3) 1-1/2" Outlet
- (2) Top Spud
- (#CP) Chrome Finish

TOTO®

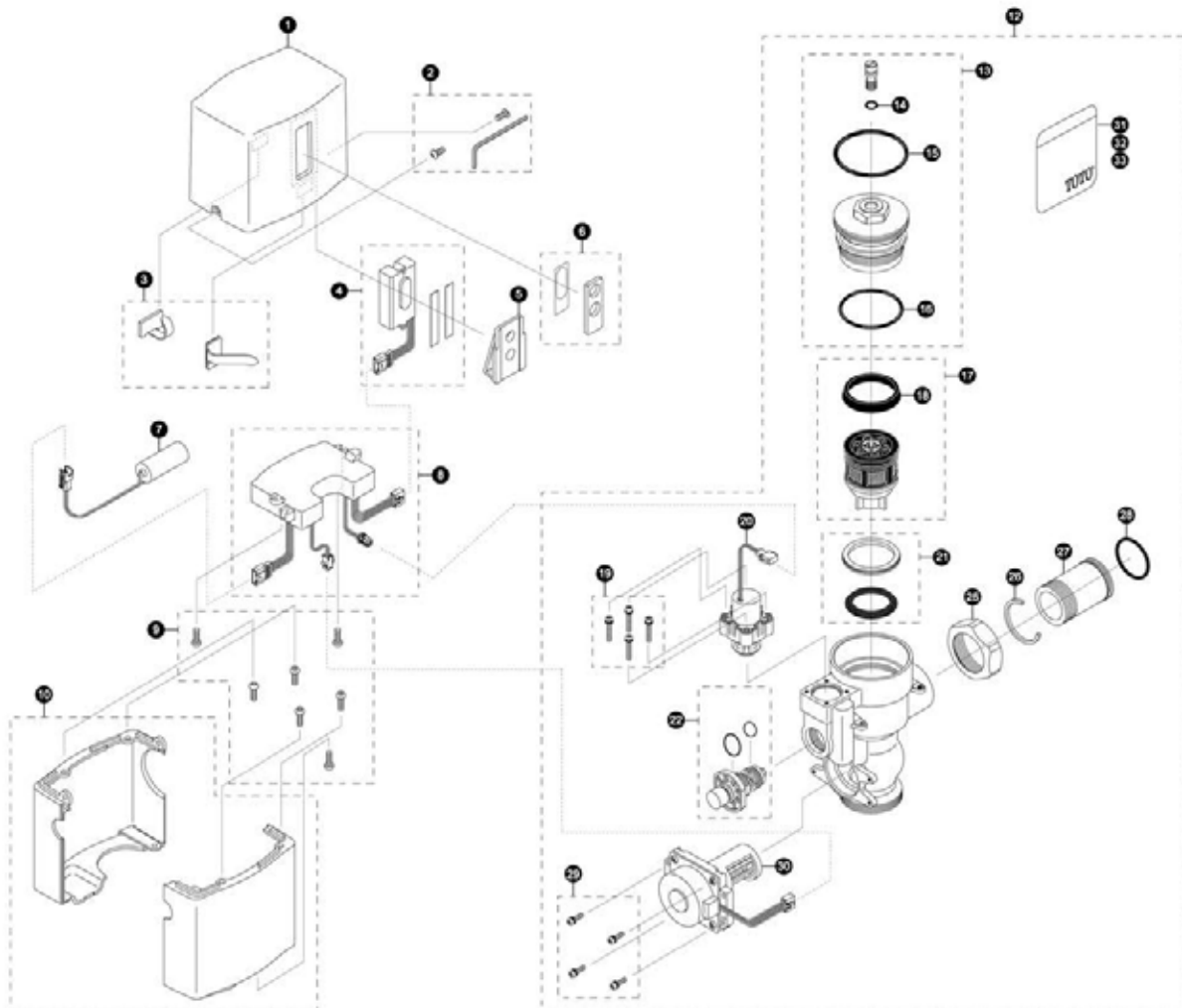

SLOAN

EBF-615 Battery Powered Faucet

- ADA compliant
- Sensor range adjustment screw
- Low battery LED indicator light
- User-friendly timeout settings
- "AA" batteries included
- 6 volt DC plug-in transformer (optional)
- Mounts on single-hole lavatory / deck
- Bak-Chek® Tee for Hot/Cold Supply
- 4" or 8" deckplates (optional)

FIG NO.
116617

OPTIMA^{plus}



EBF-650 Battery Powered Faucet

- ADA compliant
- Sensor range adjustment screw
- Low battery LED indicator light
- User-friendly timeout settings
- "AA" batteries included
- 6 volt DC plug-in transformer (optional)
- Bak-Chek® Tee for Hot/Cold Supply
- 4" mounting (8" deckplate optional)

FIG NO.
80499

OPTIMA^{plus}



EBF-85 Battery Powered Faucet

- ADA compliant
- Fiberoptic, automatic, self-adaptive sensing
- Low battery LED indicator light
- User-friendly timeout settings
- "C" batteries included
- Bak-Chek® Tee for Hot/Cold Supply
- Deckplate with anti-rotation pin

FIG NO.	DESCRIPTION
80449	4" CENTERSET
135131	8" CENTERSET

OPTIMA^{plus}



EAF-150 Battery Powered Faucet

- ADA compliant
- Modular one-piece construction with all concealed components above deck
- Automatic, self-adaptive sensing
- Low battery LED indicator light
- User-friendly timeout settings
- 6V lithium 2CR5 batteries included
- Optional 24 hour sentinel activation
- 4" or 8" deckplate (optional)

FIG NO.	DESCRIPTION
193916	FAUCET WITH INTEGRAL SPOUT MIXER
257426	REPLACEMENT LITHIUM BATTERY ONLY

OPTIMA^{i.q.}



SLOAN SOLIS™

EAF-150 Battery Powered Faucet

- ADA compliant
- Sensor range adjustment screw
- Automatic, self-adaptive sensing
- 6VDC lithium battery back-up power source included
- 6" or 8" deckplate (optional)

FIG NO.	DESCRIPTION
197226	FAUCET WITH INTEGRAL SPOUT MIXER
238939	FAUCET WITH SINGLE SUPPLY LINE



EAF-150 Battery Powered Faucet

- ADA compliant
- Sensor range adjustment screw
- Low battery LED indicator light
- User-friendly timeout settings
- "AA" batteries included
- 6 volt DC plug-in transformer (optional)
- * Ideal for commercial hand sinks!

FIG NO.

OPTIMA^{plus}



DUFF DELIVERS





Self Closing Angle Stop

SIZE	FIG. NO.	PRICE
3/8	8329	
1/2	8334	



Self Closing Straight Stop

SIZE	FIG. NO.	PRICE
3/8	8318	
1/2	8324	



Slow Closing Straight Stop

SIZE	FIG. NO.	PRICE
1/2	8556	



CENTRAL BRASS Standpipe

SIZE	FIG. NO.
3/8	8340
1/2	8346

KOHLER K-53415 Urinal Strainer

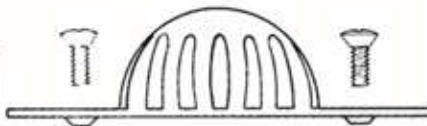

FIG. NO.	PRICE
73450	

KOHLER K-18752 Urinal Strainer



FIG. NO.	PRICE
38844	

AMERICAN STANDARD WASHBROOK STRAINER



(OLD STYLE)

FIG. NO.	PRICE
78808	

REPLACEMENT TUB ASSEMBLY



FIG. NO.	PRICE
60434	



Chrome Tip-Toe Touch Tub Drain Cartridge

FIG. NO.	THREAD
10429	5/16"
91989	3/8"

FLIP-IT TUB STOPPER



CP ABS & Delrin plastic. One piece construction. No tools required for installation.

FIG. NO.	PRICE
47002	



The Quickest Way to a Brand-New Bath Drain
In just a few minutes you can install a shiny new drain and stopper with a Watco Universal NuFit® bathtub stopper. No difficult, time-consuming work! Several finishes available.

LIFT and TURN

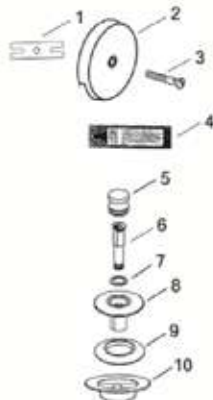

#48400 NuFIT® - LT TRIM KIT	
1. 11641	Adapter Bar
2. 01002	1-Hole Overflow Plate
3. 01024	Overflow Plate Screw, 2.25"
4. 96057	Silicone Pouch, new style
5. 01010	Knob, Brass
6. 11078	L&T "D" Pin for NuFit®
7. 1108	L&T "D" Ring
8. 01046	PP Stopper, Brass (short)
9. 11507	PP Seal, 1-1/6" dia.
10. 01044	NuFit LT Strainer Body

Requires minimum 1.390" I.D. opening
Flange covers maximum of 2.875" O.D.
Depth clearance needed = .390"

URINAL AND CLEANOUT PLUG -



Replaces bottom cleanout of wall hung china urinal.

DESCRIPTION	FIG. NO.
3/4" Kohler	50526
5/8" Kohler	50527
3/4" American Std	50529

STRAINERS



Stainless Duo Strainer - 3 1/2"

FIG. NO.	PRICE
11585	



PVC Duo Strainer. Chrome Plated - 3 1/2"

FIG. NO.	PRICE
41508	



Deep Basket Duo Strainer - 3 1/2"

FIG. NO.	PRICE
11582	



Cast Brass Duo Strainer - 3 1/2"

FIG. NO.	PRICE
43534	

BEST QUALITY!



Twist Type Duo Strainer. 3 1/2"
A sure seal!

FIG. NO.	PRICE
51664	
Basket Only	
85894	



E-Z On Duo For Stainless Sink. 3 1/2"

FIG. NO.	PRICE
11584	

Of course, we are happy to accept Visa and MasterCard



COMMERCIAL GRADE

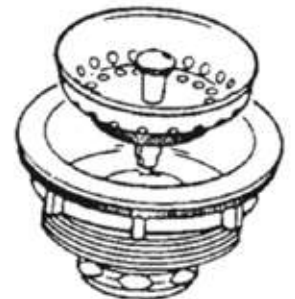

300 Series Stainless Steel Acid Resistant Duo Strainer

FIG. NO.	PRICE
52531	



Flat Top Strainer. 4 1/2" Top For sinks with 3" to 4" opening

FIG. NO.	PRICE
49218	

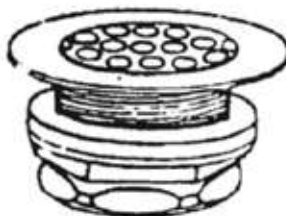

Duplex Strainer 2"

FIG. NO.	PRICE
15330	



Jr. Duo Strainer 2"

FIG. NO.	PRICE
51674	
Basket Only	
51675	



Kohler K8801 Duo Strainer

FIG. NO.	PRICE
44994	



FITALL DUO BASKET

FIG. NO.	PRICE
15328	



POST STYLE DUO BASKET

FIG. NO.	PRICE
57431	



FAUCET HOLE COVER
with

polished chrome top.
1 3/4" steel body with wingnut.

FIG. NO.	SIZE
14621	1 3/4"
132219	2"



PO BASIN PLUG
1 piece, 5" long

FIG. NO.	PRICE
51665	



SNAP-IN HOLE COVER
Stainless Steel

FIG. NO.	SIZE
14617	1 3/8"
132004	1 1/2"



CAST BRASS GRID DRAIN

1 1/4" X 6"
20 Gauge tailpiece.
Chrome plated heavy cast brass.

FIG. NO.	PRICE
44613	



POP-UP LINKAGE ONLY

FIG. NO.	PRICE
57432	



CUP STRAINER

Nickel plated catch all strainer.

FIG. NO.	PRICE
1 3/8	17831
1 1/8	17830
1 1/2	17832

BAR PLUG
Bar sink strainer.



FIG. NO.	PRICE
17840	



POP-UP DRAIN ASSEMBLY

FIG. NO.	PRICE
14590	



MACK WASHER

FIG. NO.	PRICE
1 1/4"	14629
1 1/2"	14636



HOSE AND SPRAY ASSEMBLY

	FIG. NO.	PRICE
COMPLETE	14592	
Hose Only	14593	
Head Only	14595	



WHEELCHAIR LAVATORY STRAINER - cast brass.

FIG. NO.	PRICE
49389	



WATER DISPENSER

For Designer Versions and Finishes, Please See Page 205B

FIG. NO.	PRICE
23543	

TUBULAR BRASS



Chrome Plated Extension Tube
Sweat End

SIZE	FIG. NO.	PRICE
1 1/4 X 8	11905	
1 1/4 X 12	11919	
1 1/2 X 8	11927	
1 1/2 X 12	11932	



Chrome Plated Extension Tube
Slip Joint

SIZE	FIG. NO.	PRICE
1 1/4 X 8	11934	
1 1/4 X 12	11938	
1 1/2 X 8	11943	
1 1/2 X 12	11949	



Chrome Plate Tube Threaded
Both Ends

SIZE	FIG. NO.	PRICE
1 3/8 x 12	11800	
1 1/2 x 12	11816	
1 1/4 x 12	20319	

Threaded One End

SIZE	FIG NO	PRICE
1 1/2 x 1 1/4 x 8	11827	



Chrome Plated Sink Tailpiece

SIZE	FIG. NO.	PRICE
1 1/2 x 1 1/4 x 8	52143	
1 1/2 x 1 1/4 x 12	19933	
1 1/2 x 4	11875	
1 1/2 x 8	11885	
1 1/2 x 12	11896	



20 Gauge J-Bend

SIZE	FIG. NO.	PRICE
1 1/4	11601	
1 1/2	11603	

17 Gauge J-Bend

SIZE	FIG. NO.	PRICE
1 1/4	11607	
1 1/2	11609	



Repair P-Trap
1 1/4"

FIG. NO.	PRICE
23241	

1 1/2"

FIG. NO.	PRICE
23242	



Chrome Plated
Double Offset
1 1/4"

FIG. NO.	PRICE
11959	

1 1/2"

FIG. NO.	PRICE
11963	

End Outlet
Continuous Waste

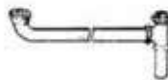

FIG. NO.	PRICE
11652	

Continuous Outlet
Waste



FIG. NO.	PRICE
11656	

2" TUBULAR!



2" 17 Gauge P Trap

FIG. NO.	PRICE
11776	



2" Chrome
Plated, 17
Gauge Tail
Piece

FIG. NO.	PRICE
11794	

DUFFNOLE:

Look for Slip Joint
Nuts & Washers on
page 207

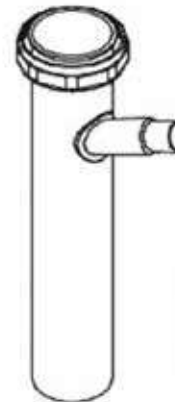

DISHWASHER
TAILPIECE

FIG. NO.
213998

P-TRAPS



17 Gauge P-Trap

SIZE	FIG. NO.	PRICE
------	----------	-------

1 1/4 11623

1 1/2 11626

20 Gauge P-Trap

SIZE	FIG. NO.	PRICE
------	----------	-------

1 1/4 11621

1 1/2 11622

S-TRAPS

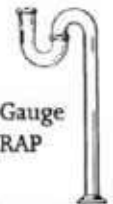

20 Gauge
S-TRAP

SIZE	FIG. NO.	PRICE
------	----------	-------

1 1/4 11632

1 1/2 11633

17 Gauge S-Trap

SIZE	FIG. NO.	PRICE
------	----------	-------

1 1/4 11635

1 1/2 11636

TUBULAR BRASS

ESCUTCHEONS



Chrome Plated Escutcheon

COP SIZE	IP SIZE	FIG. NO.	PRICE
1/2"	3/8"	11732	
	1/2"	11736	
TRAP SIZE			
	1 1/4"	11755	
	1 1/2"	11759	



Chrome Plated Bell Escutcheon

COP SIZE	IP SIZE	FIG. NO.	PRICE
1/2"	3/8"	11739	
	1/2"	11744	
TRAP SIZE			
	1 1/4"	11746	
	1 1/2"	11748	



Chrome Plated Tube Box Escutcheon

TRAP SIZE	FIG. NO.	PRICE
1 1/4"	11765	
1 1/2"	11769	

SLIP JOINT FITTINGS - TUBULAR TRAP SIZE - all sizes can reduce to 1 1/4 or 1 3/8



Chrome Plated Slip Joint Tee



Chrome Plated Slip Joint 45



Chrome Plated Slip Joint Coupling



Chrome Plated Slip Joint 90

SIZE	FIG. NO.	PRICE	SIZE	FIG. NO.	PRICE	SIZE	FIG. NO.	PRICE	SIZE	FIG. NO.	PRICE
1 1/2	12044		1 1/4	12019		1 1/4	12033		1 1/4	12012	
			1 1/2	12027		1 1/2	12037		1 1/2	12016	

SLIP JOINT NUTS

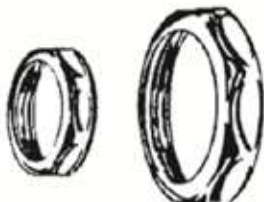

CHROME PLATED SLIP JOINT NUTS

SIZE	FIG. NO.
1 1/4	11981
1 1/2	11991
1 1/2 X 1 1/4	11997
1 1/2 X 1 3/8	12003
2	12008

CHROME PLATED BRASS SLIP JOINT NUTS

1 1/4"	42919
1 1/2"	42920

TAPERED NYLON SLIP JOINT WASHER



SIZE	FIG. NO.
1 1/4	14736
1 1/2	14738
1 1/2 X 1 1/4	14742

NYLON TAILPIECE WASHER

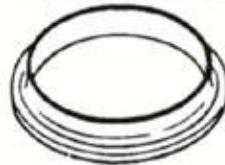

SIZE	FIG. NO.
1 1/2	14685

RUBBER SLIP JOINT WASHERS



SIZE	FIG. NO.
1 1/4"	14723
1 1/2"	14726
2"	14729
1 1/2 X 1 1/4	14731



The new LAV SHIELD lavatory enclosure represents the "Next Generation" of ADA piping protection systems. An alternative to insulation covers around each pipe and component, the designer-style, single-piece LAV SHIELD conceals all lavatory piping, electronic faucet connections, mixing valves, trap primers, and instantaneous hot water heaters" at once. The LAV SHIELD provides the proper knee and toe clearances mandated by ADA for wheelchair users, prevents pipe component tampering, and offers the aesthetics demanded by the most discriminating of designers.

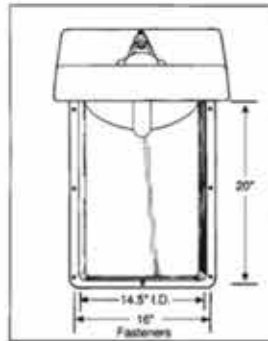
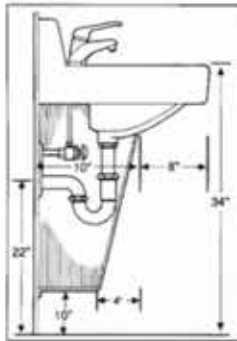

FIG. NO.	PRICE
79924	



PLUMBEREX "PRO-EXTREME"

Wheelchair Offset Strainer Cover

P-Trap Cover
 ADA Compliant for Americans with Disabilities Act
 U.S. Patent 7,100,633 other patent applied for

P-Trap Cover, Valve and Supply Cover
 (One-Piece Installation)

Wheelchair Offset Strainer - Cover Only

FIG NO.	TYPE
81266	COMPLETE P-STRAP & STOP COVER KIT (LESS OFFSET)
95953	WHEELCHAIR OFFSET STRAINER - COVER ONLY

PVC FLEXIDRAIN

Flexi-drains bend easily to correct mis-alignment. Cuts easily with a hacksaw.



SIZE	FIG. NO.
1 1/2"	12160
1 1/4"	12154



CAST BRASS NY REG. TRAPS
 Chrome-plated for heavy duty service, urinals, etc.

SIZE	FIG. NO.
1 1/2	65053
1 1/2 X 1 1/4	65054

TUBULAR PVC

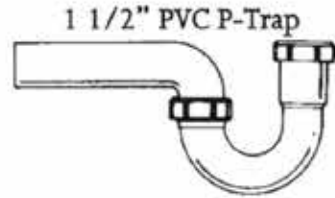

1 1/2" PVC P-Trap

FIG. NO.	PRICE
12056	

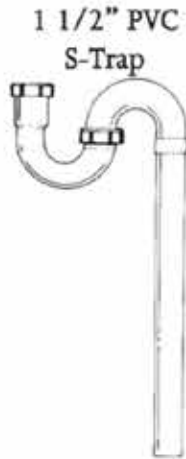

1 1/2" PVC S-Trap

FIG. NO.	PRICE
12059	

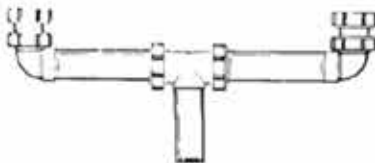

PVC Center Outlet Continuous Waste

FIG. NO.	PRICE
12073	



PVC Dishwasher Tailpiece

FIG. NO.	PRICE
12135	

WATCO FLEX BATH WASTE



FIG. NO.
243146

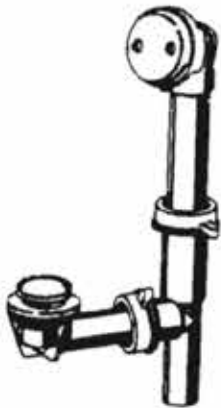

PVC Tip-Toe Waste

FIG. NO.	PRICE
50146	



PVC Trip Waste

FIG. NO.	PRICE
12149	

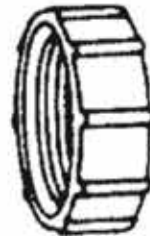

PVC Slip Joint Nut

SIZE	FIG. NO.
1 1/4	47617
1 1/2	47618

PVC Tailpiece

1 1/2" X 4

FIG. NO.	PRICE
44329	

1 1/2" X 8"

FIG. NO.	PRICE
12079	

1 1/2" X 12"

FIG. NO.	PRICE
44330	

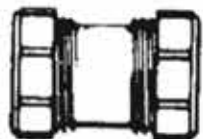

PVC Slip Joint Coupling 1 1/2"

FIG. NO.	PRICE
12137	

TUBULAR TRAP SIZE



PVC Slip Joint 90 Degree Elbow 1 1/2"

FIG. NO.	PRICE
12142	

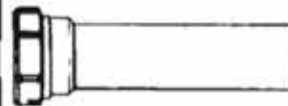

1 1/2" x 8" PVC Extension Tube

FIG. NO.
12110

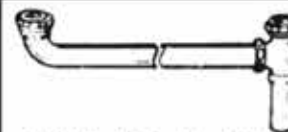

PVC End Outlet Waste

FIG. NO.	PRICE
12067	

REPAIR SPLIT NUT for repair without opening joint!

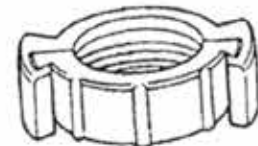

PVC. For use on PVC or chrome traps

SIZE	FIG. NO.	PRICE
1 1/4	49311	
1 1/2	47619	

CHROME PLATED SUPPLY TUBES

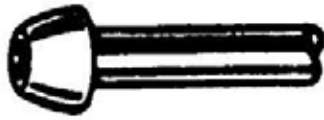

Chrome Lav Supply Tube

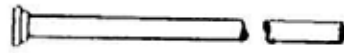

Chrome Closet Supply Tube

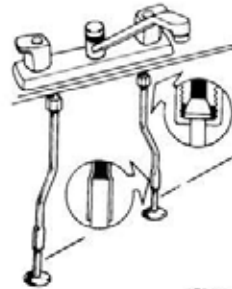

Brass Finish Jiffy Lav Tube. Pair.



Single Lever Lav Tube
3/8 x 12" Chrome Plated .Each.

SIZE	FIG. NO.	PRICE
3/8 X 12"	10930	
3/8 X 20"	10931	
3/8 X 36"	10934	

SIZE	FIG. NO.	PRICE
3/8 X 12"	10950	
3/8 X 20"	10951	

FIG. NO.	PRICE
10967	

FIG. NO.	PRICE
10970	

CHROME FLANGES



CHROME PLATED IP ESCUTCHEON	
IP SIZE	FIG. NO.
3/8"	11732 (3/8" IP same as 1/2" SWT)
1/2"	11736

CHROME PLATED SWT ESCUTCHEON	
SIZE	FIG. NO.
1/2"	11732 (1/2" SWT same as 3/8" IP)



Bonding adhesive for shower pan.

FIG. NO.	PRICE
33216	

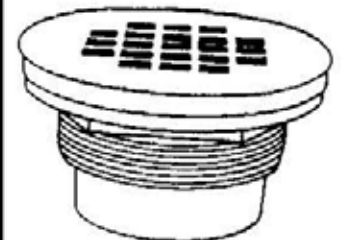

PVC no-caulk shower drain for PVC.

FIG. NO.	PRICE
42800	

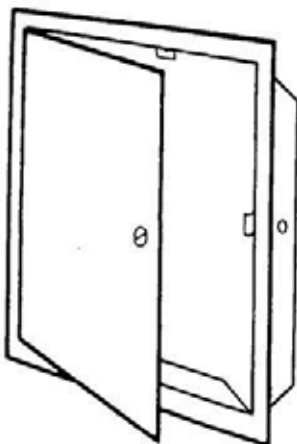

Framed Steel Access Panel (16ga.)
Also available with drywall taping bead on all sides and fire ratings

FIG. NO.	SIZE
47032	12" X 12"



PVC Access Panel Easy snap cover

FIG. NO.	SIZE
44597	14" X 14"
104953	8" X 8"
165838	6" X 9"

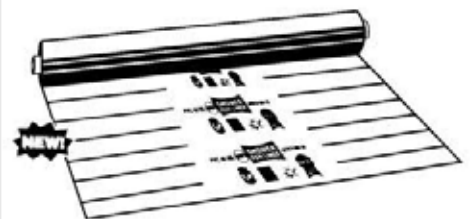

PVC Shower pan. 4 feet wide

FIG. NO.	PRICE PER SQ. FT.
33229	



3IN1 ROOF FLASHING
 Fits 1 1/4", 1 1/2, 2 or 3" vent pipe
 Fits any roof pitch-from flat to 45o
 Tested for Ultraviolet, Ozone and wather resistance.
 Thermoplastic hard base with elastomer collar

FIG. NO.	PRICE
51248	



3+4 ROOF FLASHINGS
 Fits 3" or 4" vent pipe
 Fits any roof pitch-from flat to 45o
 Tested for Ultraviolet,
 Ozone and wather resistance.
 Thermoplastic hard base with elastomer collar

FIG. NO.	PRICE
51249	



LABOR, TIME AND INVENTORY SAVINGS!

MAXI-VENT®



Installed by either push-fit installation on a 1-1/2" or 2" pipe or in a 4" pipe or through the use of a hubless coupling or solvent weld method on a 3" pipe. Cut off the inner lip of the connector (along guide marks) when used in a 4" pipe. The packaging should be used when installing the Maxi-Vent in areas subject to extreme temperatures.

FIG. NO.	SIZE
95860	1-1/2" and 2"
76611	3" and 4"



TRY AN IN-LINE FILTER FOR BETTER TASTE!

ICE MAKER/HUMIDIFIER KIT -



Self tapping valve, all necessary brass fittings
 1/4" OD tubing, FDA approved
 Used with most refrigerators, furnace humidifiers, coolers

FIG. NO.	
PLASTIC	36306
COPPER	15345

SELF TAPPING SADDLE VALVE -

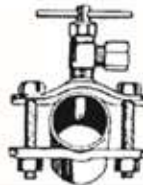

1/2" copper tube x 1/4 OD copper tube
 Heavy duty construction

FIG. NO.	PRICE
11030	



AUTOMATIC PLUMBING VENT -

Fits 1 1/2" female waste line adapter.
 Eliminates secondary stack for tubs, sinks basins, showers and washing machines
 BOCA and SBCC approved.

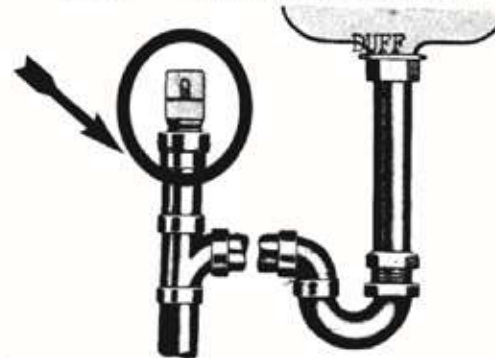

FIG. NO.	PRICE
15333	

DISHWASHER DISPOSAL CONNECTIONS (BOOT)

- With 2 stainless steel worm gear clamps.

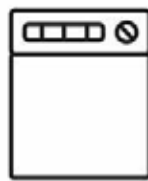

FIG. NO.	PRICE
18127	

Tee Stop



SharkBite® Tee Stops allow the user to tap into existing supply lines to add fixtures and appliances with the speed and convenience of push-fit connections to the final phase of plumbing projects. The SharkBite Tee can be used on Copper, CPVC, PEX, and PE-RT.



DISHWASHERS



HUMIDIFIERS



ICE MAKERS



1/4" (3/8" OD) SB



PRODUCT DESCRIPTION	PART #
1/2" X 1/2" X 1/4" COMP	24983
1/2" X 1/2" X 3/8" COMP	24984
3/4" X 3/4" X 1/4" COMP	24985
3/4" X 3/4" X 3/8" COMP	24986
1/2" X 1/2" X 1/4" (3/8" OD) SB	24987

SUPER FLEX STAINLESS STEEL NO-BURST CONNECTORS



FIG. NO.	SIZE
COMPRESSION X 1/2" SWIVEL NUT	
45375	3/8" X 9"
11033	3/8" X 12"
169312	3/8" X 16"
36270	3/8" X 20"
80444	3/8" x 30"
76618	3/8" x 36"
314372	3/8" X 48"
46962	1/2" X 12"
46987	1/2" X 20"
1/2 IRON PIPE SIZE	
80445	1/2" IPS x 1/2" IPS x 12"
172467	1/2" IPS x 1/2" IPS x 20"
172465	1/2" IPS x 1/2" IPS x 36"
COMPRESSION X COMPRESSION	
80611	3/8" x 3/8" x 12"
161082	3/8" x 3/8" x 20"

TOILET

Superflex connector for the toilet.



SIZE	FIG. NO.
3/8" X 9"	45376
3/8" X 12"	11034
3/8" X 20"	88663
1/2" X 12"	46943
1/2" X 20"	136846

SUPER DELTA FAUCET

3/8" comp x 3/8" Delta tube

FIG. NO.	SIZE
39911	3/8 X 12
44600	3/8 X 20

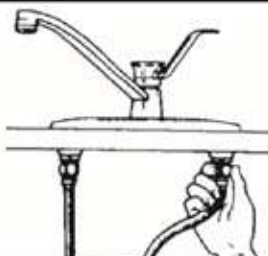

WASHING MACHINE

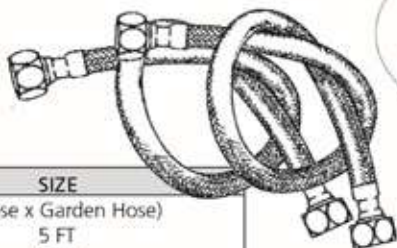
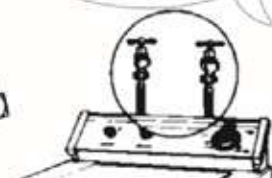

FIG. NO.	SIZE
(Garden Hose x Garden Hose)	
47351	5 FT
121918	6 FT
202864	6FT (with 90° elbow)

Ask your
DUFF rep
about
washing machine
flood stops!



GARDEN HOSE ADAPTER FOR NEW STYLE DISHWASHER



FIG. NO.
227377

WATER HEATER

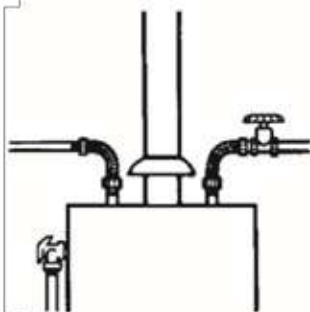

SharkBite Stainless Steel No-Burst Connectors	
FIG. NO.	SIZE (SharkBite x FPT x Length)
212783	1/2 x 3/4 x 12
274634	1/2 x 3/4 x 15
260344	1/2 x 3/4 x 18
277056	1/2 x 3/4 x 24
32833	1/2 SB Ball Valve x 3/4 x 18
307810	3/4 x 3/4 x 12
225104	3/4 x 3/4 x 15
260346	3/4 x 3/4 x 18
307811	3/4 x 3/4 x 24

SharkBite Water Heater Install Kit

FIG. NO.	SIZE (SharkBite x FPT)
227049	1/2SB x 3/4FPT
171069	3/4SB x 3/4FPT



Stainless Steel No-Burst Connectors

FIG. NO.	SIZE (FPT x FPT)
267110	3/4 X 12
267650	3/4 x 15
121577	3/4 x 18
121580	3/4 x 24

DISHWASHER

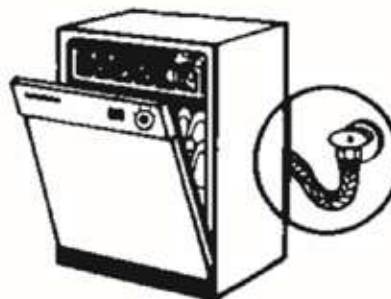

FIG. NO.	SIZE
41046	5FT. 1/2" FPT x 3/8" MPT 90° elbow
111119	5FT. 3/8" comp x 3/8" MPT 90° elbow

BrassCraft®

WATER SUPPLY STOPS (MULTI-TURN)



IPS X
Compression
Straight
Valve

IPS	OD	FIG. NO.	PRICE
3/8	3/8	10985	
1/2	1/2	10991	
3/8	1/2	10989	
1/2	3/8	10988	



IPS X
Compression
Angle
Valve

IPS	OD	FIG. NO.	PRICE
3/8	3/8	10978	
1/2	1/2	10983	
3/8	1/2	10982	
1/2	3/8	10980	



Sweat X
Compression
Straight
Valve

SWT	OD	FIG. NO.	PRICE
1/2	3/8	11001	
ROUGH BRASS			
1/2	3/8	11007	

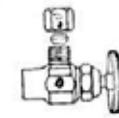

Sweat X
Compression
Angle
Valve

SWT	OD	FIG. NO.	PRICE
1/2	3/8	10998	
ROUGH BRASS			
1/2	3/8	11006	



Compression
X Compression
Angle
Valve

COP	OD	FIG. NO.	PRICE
1/2	3/8	11004	



Compression X
Compression
Straight
Valve

COP	OD	FIG. NO.	PRICE
1/2	3/8	11005	



IPS X IPS Straight
Valve

IPS	OD	FIG. NO.	PRICE
3/8	3/8	10995	
1/2	1/2	10997	

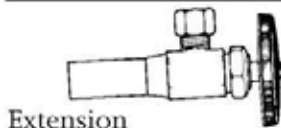

Extension
Angle Stop (5"Extension)

SWT	OD	FIG. NO.	PRICE
1/2	3/8	11008	

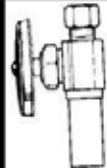

Extension
Straight Stop
(5"Extension)

SWT	OD	FIG. NO.	PRICE
1/2	3/8	11009	

Loose Key Angle Stop

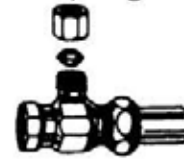

IPS	OD	FIG. NO.	PRICE
3/8	3/8	26250	
1/2	3/8	37657	

STRAIGHT Stop

3/8	3/8	50867	
-----	-----	-------	--



Compression
X Female
Straight
Adapter
Chrome Plated

FIP	OD	FIG. NO.	PRICE
3/8	3/8	11010	
1/2	1/2	11013	
3/8	1/2	11011	
1/2	3/8	11012	



Straight
Stop
Compression
Both Ends

OD	OD	FIG. NO.	PRICE
3/8	3/8	38584	

ESCUTCHEON FOR
EXTENSION STOP



SIZE	FIG. NO.	PRICE
1/2	11739	



1/2"SWT X
3/8"OD
Compression
Straight Adapter
BRASS

FIG. NO.	PRICE
11022	



3/8"
Compression
Female 90°
Elbow 3/8"OD
x 3/8"F
Chrome Plated

FIG. NO.	PRICE
11018	

**CHROME PLATED
COMPRESSION NUT AND SLEEVE**



COMPRESSION NUT		
OD SIZE	FIG. NO.	PRICE
1/2"	4470	
3/8"	4465	
COMPRESSION SLEEVE (FERRULE)		
OD SIZE	FIG. NO.	PRICE
1/2"	4427	
3/8"	4422	

**WE'RE
WAITING FOR
YOUR CALL!
610-275-4453**



Compression X
MIP Straight
Adapter
Chrome Plated

MIP	OD	FIG. NO.	PRICE
3/8	3/8	11014	
1/2	1/2	11017	
3/8	1/2	11015	
1/2	3/8	11016	

BrassCraft® WATER SUPPLY STOPS (1/4 Turn)

ADD-A-TEE EXTENSION TEE



FIG. NO.	SIZE
102416	3/8" x 3/8"
102417	3/8" x 1/4"

SWEAT X COMPRESSION - ANGLE



FIG. NO.	PART NO.	DESCRIPTION
116051	KTR19X C	1/2" Nom Sweat x 3/8" OD Comp

SWEAT X COMPRESSION - ANGLE WITH 5" SWEAT EXTENSION TUBE



FIG. NO.	PART NO.	DESCRIPTION
116053	KTC40BX C	1/2" Nom Sweat x 3/8" OD Comp with Bell Escutcheon

SWEAT X COMPRESSION - STRAIGHT WITH 5" SWEAT EXTENSION TUBE



FIG. NO.	PART NO.	DESCRIPTION
116055	KTC41BX C	1/2" Nom Sweat x 3/8" OD Comp with Bell Escutcheon

SWEAT X COMPRESSION - STRAIGHT



FIG. NO.	PART NO.	DESCRIPTION
116054	KTR14X C	1/2" Nom Sweat x 3/8" OD Comp

PUSH CONNECT SHARKBITE X COMPRESSION - ANGLE



FIG. NO.	PART NO.	DESCRIPTION
279023	G2PS09X C	1/2" Nom Push Connect x 1/4" OD Comp
203299	G2PS19X C	1/2" Nom Push Connect x 3/8" OD Comp

PUSH CONNECT SHARKBITE X COMPRESSION - STRAIGHT



FIG. NO.	PART NO.	DESCRIPTION
203297	G2PS14X C	1/2" Nom Push Connect x 3/8" OD Comp

COMPRESSION X COMPRESSION - ANGLE



FIG. NO.	PART NO.	DESCRIPTION
120915	KTCR19X C	1/2" Nom Comp x 3/8" OD Comp

COMPRESSION X COMPRESSION - STRAIGHT



Use this piggy-back valve while the old stop is still in place.

FIG. NO.	PART NO.	DESCRIPTION
120916	KTCR14X C	1/2" Nom Comp x 3/8" OD Comp
149067	KTCR11FX C	3/8" Fem Comp x 3/8" OD Comp

FIP X COMPRESSION - STRAIGHT



FIG. NO.	PART NO.	DESCRIPTION
116050	KTR10X C	3/8" FIP x 3/8" OD Comp
216615	KTR12X C	1/2" FIP x 3/8" OD Comp

FIP X COMPRESSION - ANGLE



FIG. NO.	PART NO.	DESCRIPTION
121946	KTR15X C	3/8" FIP x 3/8" OD Comp

PEX X COMPRESSION



FIG. NO.	DESCRIPTION (INSERT X COMP)
188494	3/8" x 3/8" Angle
188492	3/8" x 3/8" Straight
188495	1/2" x 3/8" Angle
188493	1/2" x 3/8" Straight

WASHING/DISHWASHER MACHINE ACCESSORIES



PLASTIC WASHING MACHINE BOX WITH VALVES

FIG. NO.	CONNECTION / TYPE
185915	MIP
37210	SWT
—	SWT with hammer arrestors
—	PEX
—	PEX with hammer arrestors



DISHWASHER HOSE - Braided with a rayon tire grade cord. An extremely durable hose - resists kinking.

FIG. NO.	PRICE
5/8 X 50' COIL	15321
5/8 PER FT	18123
7/8 X 50' COIL	15322
7/8 PER FT	18124

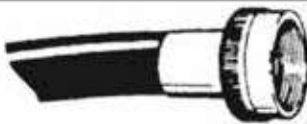

Washing Machine High Pressure Inlet

Hoses. 1/2" ID. Straight Female Swivel Hose Connection Both Ends

LENGTH	FIG. NO.	PRICE
4 Feet	15317	
5 Feet	15318	
6 Feet	15319	
8 Feet	15320	



Fit All Washing Machine Hook Hose

FIG. NO.	PRICE
15315	



Inlet Hose Filter Screen

FIG. NO.	PRICE
14759	

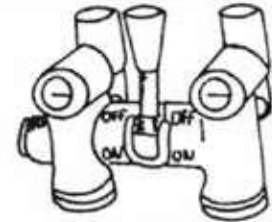

WATTS #2 Washing Machine Shut-Off Valve

FIG. NO.	PRICE
5732	

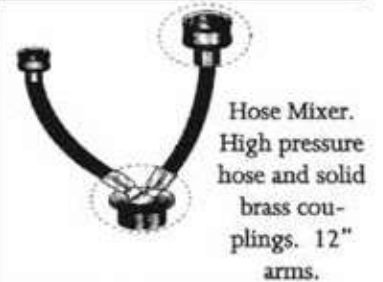

Hose Mixer. High pressure hose and solid brass couplings. 12" arms.

FIG. NO.	PRICE
15316	

DUFF DIFFERS

CALL US, WE'LL SHOW YOU HOW ...

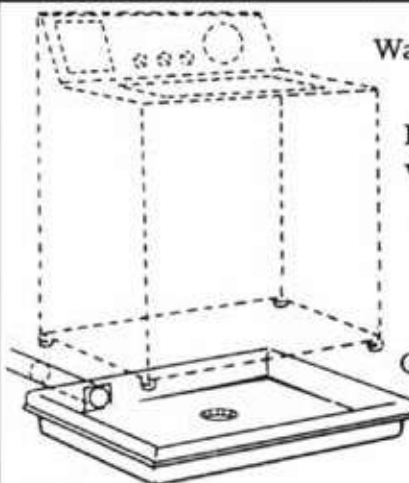

Washing Machine Drip Pan

High impact ABS plastic. Will not rust or corrode. 1" drain - can pass all codes. Bottom or side outlet. Easy to install. ID - 27" x 29" OD - 32" x 30" x 2" DEEP

FIG NO.	TYPE
19003	ABS Plastic w/PVC Drain Fitting
242586	Molded Fiberglass w/removable threshold w/o Drain Fitting

ROUGH PLUMBING



Caulking Lead. 5 LB block.

FIG. NO.	PRICE
11108	

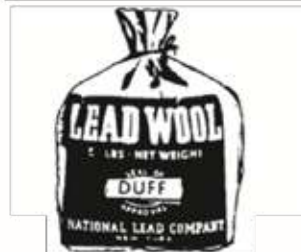

Lead Wool. 5 LB bag.

FIG. NO.	PRICE
11118	



Lavatory Hanger for iron lavatories. Extra heavy cast iron.

FIG. NO.	PRICE
62330	

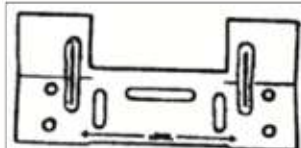

China Lav Hanger Stamped Steel

FIG. NO.	PRICE
50523	

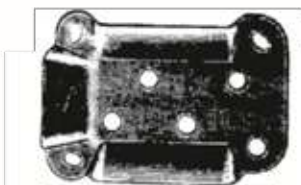

Two piece sink hanger Stamped Steel

FIG. NO.	PRICE
7427	



Sta Brite Silver Bearing Solder. 1 LB!

FIG. NO.	PRICE
11121	



Lead Free Solder. 1 LB spool.

FIG. NO.	PRICE
36274	

95/5 Solder. 1 LB spool.

FIG. NO.	PRICE
11117	



Oakum 5# Box

FIG. NO.	PRICE
7511	



Lead Cleanout Plugs

SIZE	FIG. NO.	PRICE
2	17593	
2 1/2	17594	
3	17595	
3 1/2	17596	
4	17597	
4 1/2	17598	
5	17599	
6	38907	

Sheet Lead



SIZE	WEIGHT	FIG. NO.	PRICE
3X3	3 LB	11123	
4X4	4 LB	50141	
4X4	4 LB	11122	
4X4	4 LB	11124	

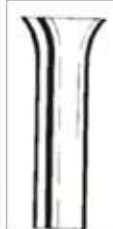

Old Style Laundry Tray FUNNEL

FIG. NO.	PRICE
11716	



Two piece china basin hanger. Stamped Steel

FIG. NO.	PRICE
50858	



Old style lavatory tray sink collar.

FIG. NO.	PRICE
7425	



SINK CLIP Fits old stype Hudee rings & many sinks & bowls.

FIG. NO.	PRICE
62329	

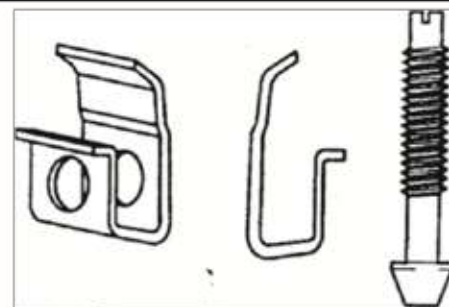

SINK CLIP Screw and clip. For Elkay, Moen, Federal.

FIG. NO.	PRICE
50797	

STAINLESS STEEL SINKS

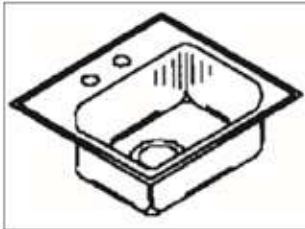

Self-Rimming 15" x 15" Stainless Steel Bar Sink - Less Fittings

FIG. NO.
14677

Mini Kitchen Sinks

FIG. NO.	SIZE	HOLE
240736	17" x 21" x 6"	3
186032	19" x 19" x 7-1/2"	3

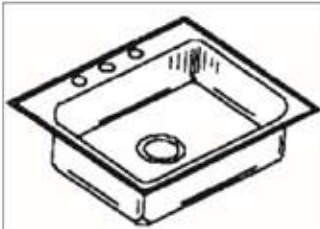

PREMIUM GRADE High Polish Self-Rimming 22" x 25" Stainless Steel Sink

FIG. NO.	DEPTH	HOLE
133896	8"	3
14673	6"	3
208383	6"	4
249709	8"	3
218364	7"	3

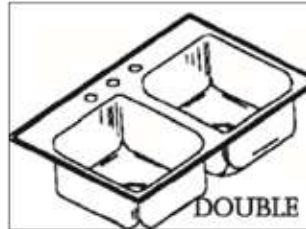

Self-Rimming 13" x 22" Stainless Steel Sink

FIG. NO.	DEPTH	HOLE
193946	6"	3
268423	8"	3
274800	8"	4
14671	6"	4

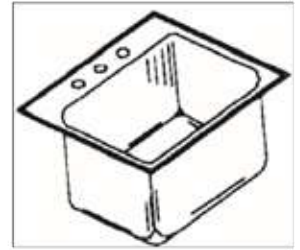

Commercial Drop-In Bowl NSF, Heavy Gauge

Many sizes available — Call for pricing!

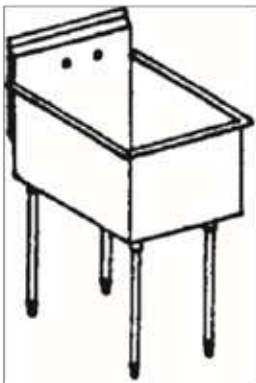

Stainless Steel Utility Sinks

FIG. NO.	SIZE
18153	21" x 24"
22389	24" x 24"



Two or Three Compartment Sinks Available in utility and food grade styles with left and/or right drainboards!

For sanitizing booster, please see page 276 in the heating section



Combination Hand Sink 14" x 18-7/8" x 12-3/4"

FIG. NO.
14678



Combination Hand Sink complete with hands-free sensor faucet

FIG. NO.
316699

CORNER COVE SINKS



Stainless Steel Single Bowl Corner Cove Sink



For Restaurant Applications

Available in all sizes 12" & 14" depths

Call for Specs and Prices 610-275-4453



Stainless Steel Double Bowl Corner Cove Sink

DUFFNOTE:
DRAINBOARDS AVAILABLE!



LAUNDRY TRAYS



MUSTEE

Preferred by the "Pros"

LAUNDRY TRAY
DURASTONE
Heavy Duty

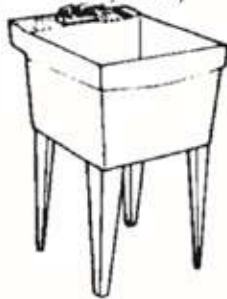

SINGLE BOWL
23 1/2 X 23 W

FIG NO	PRICE
wall mount 7946	
floor mount 7941	



DOUBLE BOWL
24 X 40 W

FIG NO	PRICE
wall mount 7950	
floor mount 7948	

LAUNDRY TRAY
UTILITUB



SPACE SAVER STYLE
23 X 18 1/2

FIG. NO.	TYPE
7939	COMPLETE
52342	LEG KIT ONLY

DURASTONE
Mop Basin, 10" height

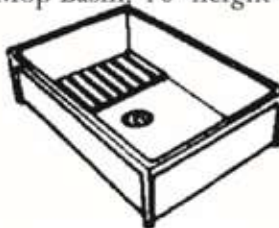

Complete with MOLDED PVC drain assembly - includes black drain seal to 2" or 3" iron, PVC or ABS

SIZE	DRAIN	FIG. NO.	PRICE
24X24	3"	251746	
24X36	3"	80666	

LAUNDRY/UTILITY BAR SINK
SELF-RIMMING
countertop installation

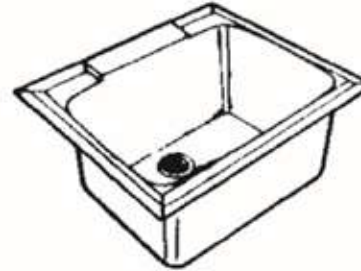

25X25X13	These and other sizes available upon request
20X17X10	

Faucet Block.

Reinforced white plastic with 1 1/4" steel washers and screws use with overhead faucet supply. 1 1/4" x 5 1/2" - 1 3/8" deep

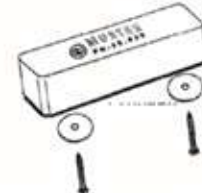

FIG. NO.	PRICE
8244	

Chrome Plated Laundry Tray
Faucet

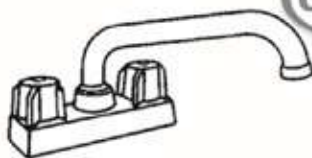

FIG. NO.	PRICE
8033	

Rough Brass Laundry Tray
Faucet



FIG. NO.	PRICE
8147	

DUFFNOTE:

DUFF Specialists are available to answer your questions.
610-275-4453

or
info@Duffco.com



DUFF DELIVERS



American Standard

CADET II EL 1.6

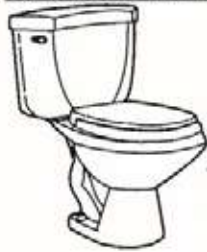

1.6 GPF Elongated Toilet

(Vitreous China)

- LESS SEAT
- 12" rough
- Siphon flushing action
- Speed connect tank/bowl coupling system
- Color matched trip lever
- WHITE

Other colors available!

FIG. NO.	PRICE
52690	

COMMERCIAL CHINA

CADET II RF 1.6



1.6 GPF Round Front Toilet (Vitreous China)

- LESS SEAT
- 12" rough
- Siphon flushing action
- Speed connect tank/bowl coupling system
- Color matched trip lever
- WHITE

Other colors available!

FIG. NO.	PRICE
52689	

CADET II 17" HIGH ELONGATED 1.6 GPF



1.6 GPF Elongated (Vitreous China)

- LESS SEAT
- 12" rough
- Siphon flushing action
- Speed connect tank/bowl coupling system
- Color matched trip lever
- WHITE

Other colors available!

FIG. NO.	PRICE
55214	
	when installed, top of seat is 17" to 19" from the finished floor.

CADET 1.6 PA

1.6 GPF Pressure Assisted Elongated



- LESS SEAT
- 12" rough
- Pressure assisted siphon jet flushing action
- Speed connect tank/bowl coupling system with hex nuts
- Color matched trip lever
- WHITE
- Other colors available!

FIG. NO.	PRICE
ROUND	—
ELONGATED	55657

CADET II 1.6 ROUND

1.6 GPF Round Front Toilet



- LESS SEAT
- 10" or 14" rough
- Siphon jet flushing action
- Speed connect tank/bowl coupling system
- Color matched trip lever
- WHITE
- Other colors available!

FIG. NO.	PRICE
10"	55218
14"	50311

AFWALL ELONGATED

Wall Hung Flush Valve Toilet (Vitreous China)



- LESS SEAT
- Top spud
- Siphon jet flushing action
- WHITE
- Other colors available!

FIG. NO.	PRICE
43256	

MADERA ELONGATED

1.6 GPF Elongated Toilet (Vitreous China)



- 1.6 GPF
- LESS SEAT
- 14 1/8" rim height
- 10" rough
- Top spud
- Flush valve toilet
- WHITE
- Other colors available!

FIG. NO.	PRICE
14641	

MADERA 17" ELONGATED

1.6 GPF ELONGATED TOILET (Vitreous China)



- 1.6 GPF
- LESS SEAT
- 17" rim height
- 10" rough
- Top spud
- Flush valve toilet
- WHITE
- Other colors available!

FIG. NO.	PRICE
49107	

AFWALL ADA RETROFIT

ADA bowl replaces standard wallhung 3.5 GPF or 1.6 GPF models and roughs-in at 16-1/8" rim height to meet ADA with no need to modify the existing carrier or through wall supply

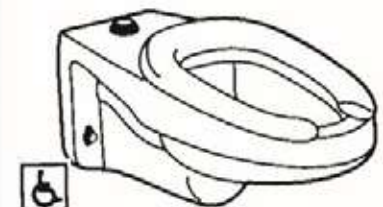

FIG. NO.	PRICE
137580	

COMMERCIAL CHINA

GLENWALL EL



Elongated toilet
(vitreous china)
● Less Seat
● Siphon Jet flushing action

● White

FIG. NO.	PRICE
56354	

WASHBROOK



0.7-1.0 GPF Urinal
(Vitreous China)
● Washout flush action
● 14" extended rim
● Meets ANSI flush requirements with low flow flush valve at 0.7

to 1.0 GPF (min. GPM 8.0 flow rate).

● 3/4" top spud

● Wall hangers

● Outlet connection.

● WHITE Other colors available!

FIG. NO.	PRICE
43248	

TRIMBROOK



.085-1.0 GPF Urinal
(Vitreous China)
● Siphon jet flush action
Meets ANSI flush requirements with low flow flush valve at .085 to 1.0 GPF (min. GPM 13.0 flow rate).

● 3/4" top spud

● Wall hangers

● Outlet connection.

● WHITE

Other colors available!

FIG. NO.	PRICE
43246	

AQUALYN COUNTER-TOP LAVATORY (Vitreous China)

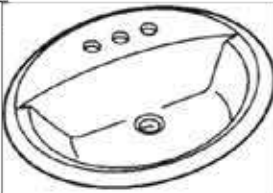

● Self-rimming
● Template and color-matched sealant included!
● 508x432mm (20"x17")
● WHITE Other colors available!

FIG. NO.	PRICE
43250	

RONDALYN COUNTERTOP LAVATORY (Vitreous China)



● Self-rimming
● Template
● 483mm (19" diameter)
● WHITE Other colors available!

FIG. NO.	PRICE
43249	

ALLBROOK



0.7-1.0 GPF Urinal
(Vitreous China)
● Siphon jet flush action
● 14" extended rim
● Meets ANSI flush requirements with low flow flush valve at .07 to 1.0 GPF (min. GPM 8.0 flow rate).

● 3/4" top spud

● Wall hangers

● Outlet connection.

● WHITE Other colors available!

FIG. NO.	PRICE
43245	

WHEEL CHAIR USERS

LAVATORY

WALL HUNG LAVATORY (Vitreous China)



● 686x508mm (27"x20")
● Faucet holes on 102 mm (4") centers
● Arranged for concealed arm carrier by others.
● WHITE Other colors available!

FIG. NO.	PRICE
50314	

CORNER MINETTE

WALL HUNG LAVATORY (Vitreous China)



● 279X413MM (11"X16 1/4")
● Faucet holes on 102mm (4") centers
● Furnished with 2 wall hangers
● WHITE Other colors available!

FIG. NO.	PRICE
61781	

LUCERNE

WALL HUNG LAVATORY (Vitreous China)



● 508x457 mm (20"x18")
● Faucet holes on 102mm (4") centers
● Wall hanger included
● Concealed arms by others
● WHITE Other colors available!

FIG. NO.	PRICE
44592	



PENGUIN VITREOUS CHINA

MODEL 524

Two-piece closed couple, elongated bowl, 12" rough-in, gravity feed elongated toilet with secondary drain system Vitreous China

FEATURES:

- Exclusive Penguin Protection: secondary drain system that helps protect against toilet overflows
- HET 1.28gal/ 4.8Liter per flush WATERSENSE LISTED
- Drop in replacement for existing toilets with 12" rough-in
- New taller elongated bowl design that meet ADA with approved seat
- Comes complete with 3" Fluidmaster flushing system
- Fully glazed trapway with Sani-Glaze
- Left hand trip lever

APPLICABLE CODES & STANDARDS:

- ASME A112.19.2
- GC 252-07
- CSA B45-02 (Supplement No. 1-2004)
- IAPMO/ UPC
- ADA Compliant

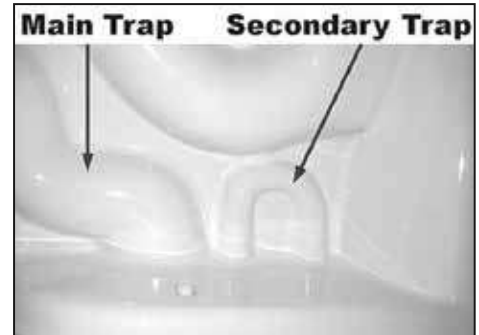

PART DESCRIPTION	509	524	527	PRO09	PRO24
22400A series Fluidmaster pilot, 15/16" plastic w/shank washer installed refill tube installed	22400A303B	400A233B	400A259B (Anti-Siphon Fill Valve)	22PRO45003B	22PRO45004B
3" High Performance flush valve	22540A45B	540A14B	920SB-FIC-013 (Dual Flush Valve)	22540A45B	540A14B
Torque Guard, Locknut	B5-1271	B5-1271	B5-1271	B5-1271	B5-1271
Refill Clip	B12-350	B12-350	B12-350	B12-350	B12-350
3" Locknut	B5-2149	B5-2149	B5-2149	B5-2149	B5-2149
3" Tank to Bowl Gasket	B5-1719-02	B5-1719-02	B5-3114 (2")	B5-1719-02	B5-1719-02
Tank to Bowl Mounting Kit (Brass)	B5-1870	B5-1870	B5-1870	B5-1870	B5-1870
Bolt and Base	B7115	B7115	B7115	B7115	B7115
Lever, chrome plated, brass arm	684BX	684BX	684BX	684BX	684BX
Wax toilet bowl gasket with brass kit	7528	7528	7528	N/A	N/A
Coupling nut	B234	B234	B234	N/A	N/A
Coupling washer	B434	B434	B434	N/A	N/A

GERBER VITREOUS CHINA



**MAXWELL SERIES
TWO-PIECE TOILETS
Round Front**

- Low Consumption 1.6 gpf
- Slim Line Tank
- Glazed Trapway
- Reverse Trap
- Front Jet Flushing Action
- Front Tank Lever
- White
- Call for other colors
- 2 Bolt Caps
- Seat not included



FIG. NO.	ROUGH-IN
55168	12"
55200	10"
55208	14"

**MAXWELL SERIES
TWO-PIECE TOILETS
Elongated Front**

- Low Consumption 1.6 gpf
- Slim Line Tank
- Glazed Trapway
- Reverse Trap
- Front Jet Flushing Action
- Front Tank Lever
- White
- Call for other color and rough-in options
- 2 Bolt Caps
- Seat not included



FIG. NO.	ROUGH-IN
55206	12"
215317	12" ADA Ergo height (17")

**VIPER SERIES
TWO-PIECE TOILETS
Elongated Front**

- Low Consumption 1.6 gpf
- Elongated Bowl
- Slim Line Tank
- Fluidmaster® Fill Valve
- HP-2 Technology
- Glazed Trapway
- Reverse Trap
- Dual Feed Jet
- White
- 2 Bolt Caps
- Seat not included



FIG. NO.	ROUGH-IN
219733	12"

**AVALANCHE SERIES
TWO-PIECE TOILETS
Elongated Front**

- Low Consumption 1.6 gpf
- ADA/ErgoHeight (17") Elongated Bowl
- Slimline Tank With Side Trip Lever
- Fluidmaster® Fill Valve
- Gerber XP3 Flushing Technology
- 3" Flush Valve
- Glazed Trapway
- Reverse Trap
- Dual Feed Jet
- White
- Call for other color and rough-in options
- 2 Bolt Caps
- Seat not included



FIG. NO.	ROUGH-IN
214637	12"

**ULTRAFLUSH
PRESSURE ASSIST TOILETS**

- Low Consumption 1.6 gpf
- Pressurized Flushing Action
- Siphon Jet
- 12" Rough-in
- Call for other color and rough-in options
- 2 Bolt Caps
- Seat not included



FIG. NO.	TYPE
112607	Round-front
125318	Elongated-front
126869	Elongated-front ADA/ErgoHeight (17")

**MAXWELL SERIES®
Wall-Hung Elongated
Back Outlet Toilet**

- Low Consumption 1.28 gpf
- Dual-Fed Siphon Jet
- Pilot Fill Valve
- 3" Flush Valve
- Color-Matched Tank Lever



FIG. NO.	ROUGH-IN
110561	4"

GERBER VITREOUS CHINA



**WALL HUNG
ELONGATED
TOP SPUD BOWL**

- Direct replacement for Am. Std Afwall
 - Low Consumption 1.6 gpf
 - 1 1/2" Spud for Flushometer Valve
 - Siphon Jet
 - ADA Compliant
 - White
- Seat not included

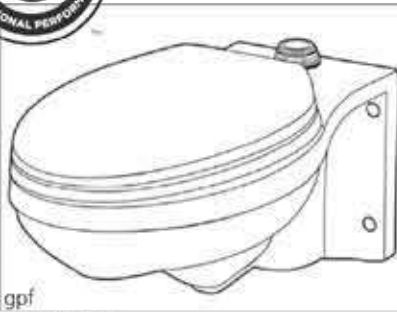

FIG. NO.
125327



**ULTRA FLUSH 1.1
PRESSURE-ASSIST
TOILET**

- Water Conservation 1.1 gpf
 - Elongated Bowl
 - Wall Waste Outlet
 - Pressurized Flushing Action
 - Siphon Jet
 - Front Tank Lever
 - 2 Bolt Caps
- Seat not included



FIG. NO.
215794

**ELONGATED
TOP SPUD BOWL**

- Low Consumption 1.6 gpf
 - 10" rough-in
 - Commercial height (14")
 - Siphon Jet
 - 1 1/2" Spud For Flushometer Valve
 - Large trapway
- Seat not included



FIG. NO.
125326

**17" HIGH ADA
ELONGATED
TOP SPUD BOWL**

- Low Consumption 1.6 gpf
 - 10" rough-in
 - Siphon Jet
 - Large Trapway
 - Quiet Refill
 - 1 1/2" Spud For Flushometer Valve
 - ADA compliant
- Seat not included



FIG. NO.
68435



**PEEWEE TWO-PIECE
CHILDREN'S TOILET**

- Ergonomically Designed for Toddlers
- 10" Rough-In
- Low Consumption 1.6 gpf
- Siphon Jet
- Toilet-In-A-Box Configuration:
 - Toilet bowl
 - Tank with lever
 - Toilet seat
 - Wax ring
 - Floor bolts



FIG. NO.
232272

**AVALANCHE GRAVITY
ONE-PIECE TOILET**

- Low Consumption 1.28 gpf
- 12" rough-in
- Elongated-front ADA/ErgoHeight (17")
- Compact design fits in round front space
- Dual-fed siphon jet
- Fluidmaster fill valve
- 3" flush valve with XP3 flushing technology
- 2" glazed trapway
- Color matched side tank lever
- Toilet seat included



FIG. NO.
267078



ECONOMY CHINA FIXTURES



CLINTON™

Siphon Jet/Top Spud Wall Hung

- Low Consumption 1.0 gpf
- Dual Hangers
- For Exposed Flushometer (top spud)
1" x 3/4" Inlet
- 2" S.P.S. Female Outlet Connection Supplied
- ADA Compliant

FIG. NO.
98829



LAFAYETTE™

Washout Wall Hung

- Low Consumption 1.0 gpf
- Integral Strainer
- One-Piece Hanger
- For Exposed Flushometer (top spud)
1" x 3/4" Inlet
- 1-1/2" x 1-1/2" Outlet
- ADA Compliant

FIG. NO.
14649

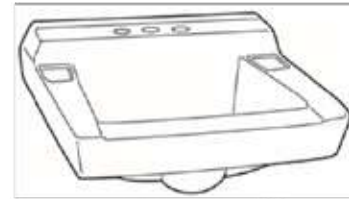

PLYMOUTH™
**Ledge Type Wall Hung Lava-
tory**

- 19" x 17" Wall-Hung Lavatory
- 4" Faucet Centers
- Two Integral Self-Draining Soap Dishes
- Concealed front Overflow
- Fast Aligning One-Piece Wall Hanger
- Various Colors
- ADA Compliant

FIG. NO.
17669

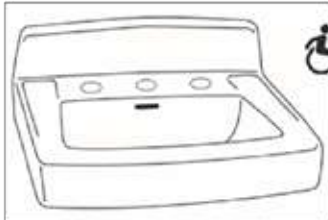

MONTICELLO II™
Back Splash

- 20" x 18" Back Splash Lavatory
- 1 Hole (Special Order)
- 4" Centers
- 8" Centers (Special Order)
- 2 Integral Self-Draining Soap Dishes
- Back Overflow
- Fast Aligning 1-Piece Wall Hanger
- Punched for use with Concealed Carrier
- ADA Compliant

FIG. NO.
231406

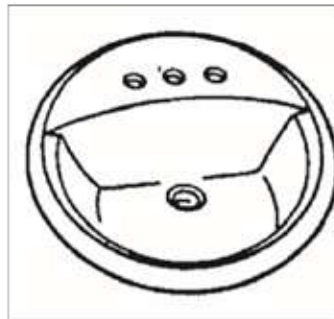

ROUND CHINA
LAVATORY BOWL

- Economy model
- White
- Other colors available

FIG. NO.
43237

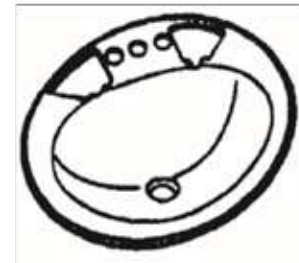

PORCELAIN ON
STEEL ROUND
LAVATORY BOWL

- 19" round
- 4" center
- White
- Other colors available
- Self-rimming

FIG. NO.
14661

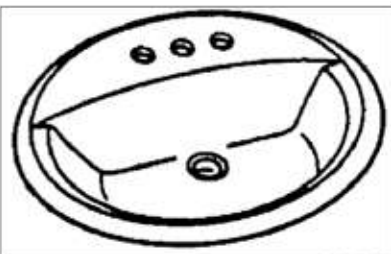

OVAL CHINA
LAVATORY BOWL

- Economy model
- White
- Other colors available

FIG. NO.
43239

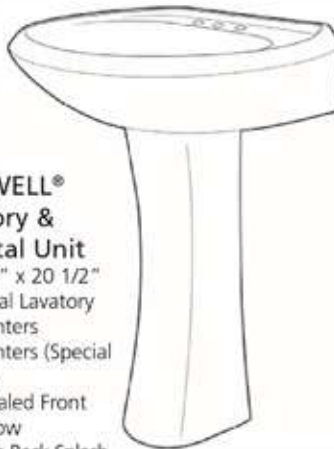

MAXWELL®
Lavatory &
Pedestal Unit

- 25 1/2" x 20 1/2" Pedestal Lavatory
- 4" Centers
- 8" Centers (Special Order)
- Concealed Front Overflow
- Discrete Back Splash
- White, (Bone, Biscuit Special Order)

FIG. NO.
238832



ENAMELED
STEEL TUBS

- White
- Other colors available

FIG. NO.	SIZE
44462	5' LH
14652	5' RH
44445	4-1/2' RH
44464	4-1/2' LH

DUFF TIP:
For our wide variety of Bathroom Vanites, please see the CABINET section

ALSO READILY AVAILABLE THROUGH DUFF COMPANY



Roof Drain

READILY AVAILABLE!



Domes.
Available in
Cast Iron or
Plastic

READILY AVAILABLE!



Gravel Stop.
Please specify the
manufacturer of
your drain!

READILY AVAILABLE!



Floor Drain

READILY AVAILABLE!

Chair Hanger, Wall Hung Toilet Support

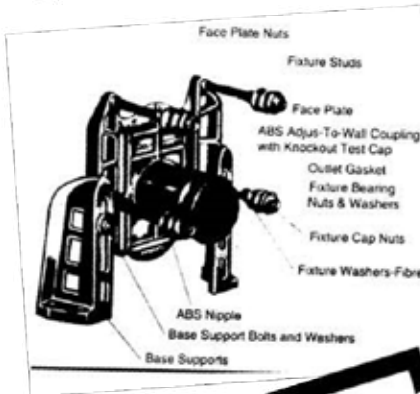

READILY AVAILABLE!



Fit all gravel clamp.

READILY AVAILABLE!

Hair Trap. Available 1 1/4,
1 1/4 x 1 1/2, 1 1/2



READILY AVAILABLE!

Concealed Arms, Lavatory Hangers.



READILY AVAILABLE!

JOSAM

SMITH



WATTS[®]
DRAINAGE

MIFAB[®]
Our Reputation is Stainless

WADE

ZURN

ASHLAND[®]

WATTS DRAINAGE PDI CERTIFIED GREASE TRAPS



Watts Drainage WD Series PDI Certified recessed or floor mounted epoxy coated steel grease interceptor with gasketed epoxy coated steel skid-proof cover secured with hex head center bolt(s), removable baffle assembly, deep seal trap with cleanout, external cast iron flow control fitting, and no hub (standard) connections.

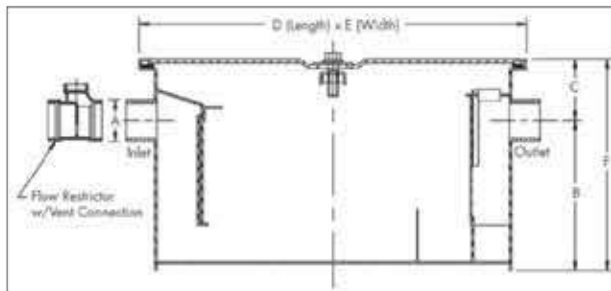

Flow Rate (Select One)			Options (Select One or More)		
Suffix	Description		Suffix	Description	
4	4 GPM	<input type="checkbox"/>	B	Sediment Bucket	<input type="checkbox"/>
7	7 GPM	<input type="checkbox"/>	E	Extension	<input type="checkbox"/>
10	10 GPM	<input type="checkbox"/>	FC	Flange & Clamp Device	<input type="checkbox"/>
15	15 GPM	<input type="checkbox"/>	HD	Heavy Duty (10,000 lb.) Traffic Cover	<input type="checkbox"/>
20	20 GPM	<input type="checkbox"/>	O	Inlet & Outlet other than Standard Size	<input type="checkbox"/>
25	25 GPM	<input type="checkbox"/>	SS	Stainless Steel	<input type="checkbox"/>
35	35 GPM	<input type="checkbox"/>	THD	Threaded Connections	<input type="checkbox"/>
50	50 GPM	<input type="checkbox"/>	US	Buy American Compliant	<input type="checkbox"/>

Interceptor Catalog Number	Flow Rate GPM	Grease Capacity Lbs	A Inlet & Outlet	B	C	D	E	F
				Base to Center	Top to Center	Length	Width	Height
WD-4	4	8	2"(51)	7-3/4"(197)	3-1/4"(83)	16"(406)	10"(254)	11"(279)
WD-7	7	14	2"(51)	8-1/2"(216)	3-1/2"(89)	18"(457)	13"(330)	12"(305)
WD-10	10	20	2"(51)	8-1/2"(216)	3-1/2"(89)	21-3/4"(552)	14"(356)	12"(305)
WD-15	15	30	2"(51)	10-1/2"(267)	3-1/2"(89)	22"(559)	15"(381)	14"(356)
WD-20	20	40	3"(76)	11-1/2"(292)	3-1/2"(89)	24"(610)	15-3/4"(400)	15"(381)
WD-25	25	50	3"(76)	12"(305)	4-1/2"(114)	26"(660)	16-1/2"(419)	16-1/2"(419)
WD-35	35	70	3"(76)	14"(356)	5"(127)	30"(762)	18"(457)	19"(483)
WD-50	50	100	4"(102)	16"(406)	5-1/2"(140)	32"(813)	22"(559)	21-1/2"(546)

DUFF POLYTRAP GREASE INTERCEPTORS



- Certified to the exacting standards of PDI.
- Listed by other local code authorities and national standards groups such as IAPMO and UPC.
- PolyTrap® is Superior to metal, fiberglass, or specially treated materials that are promoted as "preventing corrosion". PolyTrap® grease interceptors include a completely integrated surf guaranteed not to corrode, chip, peel or leach.
- Leak-proof, seamless constructed tank, manufactured with high quality material that provides enhanced stiffness in combination with impact resistant properties.
- Lightweight, easy to handle and install – yet durable and sturdy to withstand the most rigorous applications of the plumbing industry.
- The unique resin used allows for use in applications requiring high temperature continuous service. No comparable material like it.
- Smooth, non-stick surface allows for easier and more complete cleaning, Stay's Clean Looking.
- Surfaces discourage bacteria build-up.
- High value for you – the customer.
- Fast Delivery, in stock.
- Can be used on floor or in ground flush to floor.
- Can be shipped anywhere for very low cost compared to metal competitors.

DATA ON DIMENSIONS & SPECIFICATIONS

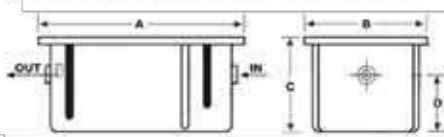

Options and Considerations for ordering

- All dimensions are nominal and may vary from table.
- 4800 Series models include flow control device.
- Matte finish on all covers to reduce slipping.
- Special HD Diamond Plate cover over-lays are available for pedestrian traffic areas.
- All units include removable baffle and internal air-relief.
- * Check on code approval status & availability.

Model Number	4804	4807	4810	4815	4820	4825	4835	4850	75*
Flow Rate G.P.M.	4	7	10	15	20	25	35	50	75
Grease Capacity (lbs.)	8	14	20	30	40	50	70	100	150
Approximate Dimensions (inches)	Length (A)	16.25	20	23	23	29	32.5	32.5	44.25
	Width (B)	10	14.5	14.5	19.5	19.5	19.5	22	25
	Height (C)	10.25	11.75	13.375	14	14.75	18	19	19
Bottom of unit to center of inlet/ outlet (D)	7	7.50	8.50	9.25	10.50	13	13.5	13.5	19.25
Nom. Wall Thickness (in.)	3/16	3/16	3/16	3/16	3/16	3/16	3/16	3/16	3/16
Approximate Weight (lbs.)	10	15	18	25	30	35	40	50	72
Standard Inlet/Outlet (in.)	2	2	2	2	2	3	3	3	3
Liquid Holding Capacity (gal)	2.3	5.6	7.3	12.1	17.6	24.8	30.0	40.5	61.8

*Certification Pending.

TOILET SEATS

Elongated Commercial Seat - Open front, less cover. Solid Plastic.



COLOR	FIG. NO.	TYPE
White	7185	
Black	7184	
Bone	78239	
White	33852	S/S Hinge
White	266241	Fire Retardant

Elongated Residential Seat - Closed front, with cover. Solid Plastic.

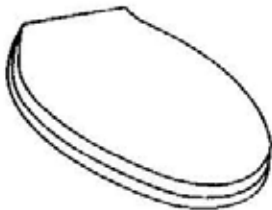

COLOR	FIG. NO.	TYPE
White	33847	
Bone	33848	
Beige	46497	
White	136009	Slow Close

BEMIS

Elongated Commercial Seat - Open front, with cover. WHITE. Solid Plastic.

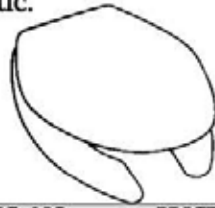
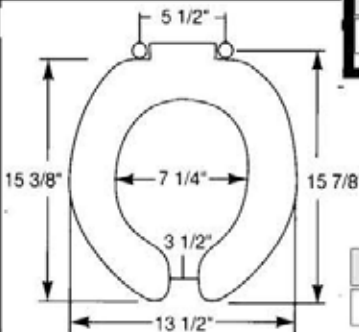

FIG. NO.	PRICE
7181	

Extra Heavy Elongated Commercial Seat - Open front, less cover. Solid Plastic.



COLOR	FIG. NO.	PRICE
White	7177	
Black	7178	



Round Commercial Seat - Open front, less cover. Solid Plastic.

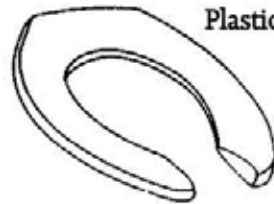

COLOR	FIG. NO.	PRICE
White	7175	
Black	7176	

Elongated Residential Seat - Closed front, with cover. Molded wood.

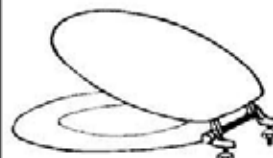

COLOR	FIG. NO.	PRICE
White	19156	

YOUTH open front less cover

FIG. NO.	PRICE
33856	

ROUND Commercial Seat Closed front, with cover. Solid plastic. White.

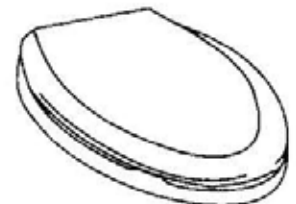
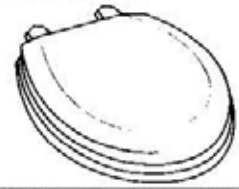

FIG. NO.	PRICE
33839	

OPEN FRONT

FIG. NO.	PRICE
7173	

Round Residential Seat - Closed front, with cover. Molded wood.



COLOR	FIG. NO.	PRICE
White	7231	
Beige	7234	
Silver	46948	
Bone	46949	
Pink	46950	
Black	46951	
Blue	46952	
Gold	46953	

BEMIS

MEDICAID SEAT - Fits flush valve or tank type closet.

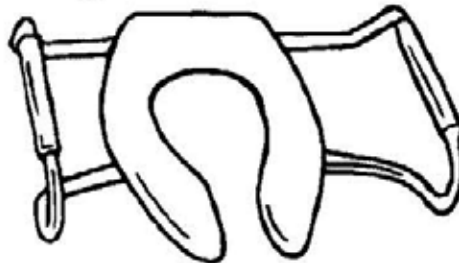
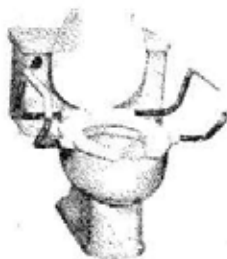

DESCRIPTION	FIG. NO.	TYPE
Elongated less lid	7230	Open Front
Elongated with lid	7231	Open Front
Round less lid	—	Open Front
Round with lid	7218	Open Front
Elongated with lid	7221	Closed Front

LIFT SEAT - Raises seat to 20 1/2" both seat and lift raise for easy cleaning. Seat sold separately.

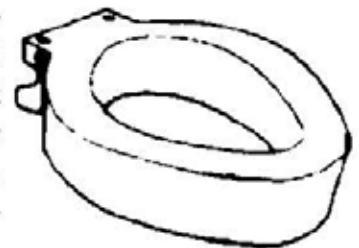

DESCR	FIG. NO.	PRICE
Elongated	49190	
Round	19157	

TOILET REPAIRS

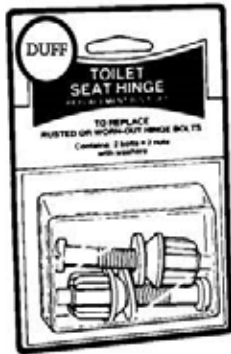

Toilet Seat Hinge Bolt Set. Pair.

FIG. NO.	PRICE
49221	



Close Coupled Bolt and Washer Kit. Pair.

FIG. NO.	PRICE
47852	



Close couple bolt, washers and tank to bowl gasket kit.

FIG. NO.	PRICE
245656	

Fits Most	245656
Amer Std	47852
Gerber	66809
Kohler	66810



Toilet Screw Set. Pair.

FIG. NO.	PRICE
15072	



BRASS PLATED Closet bolt Set. (PR)

SIZE	FIG. NO.	PRICE
1/4	42917	
5/16	42918	
1/4 XTRA LONG	37307	

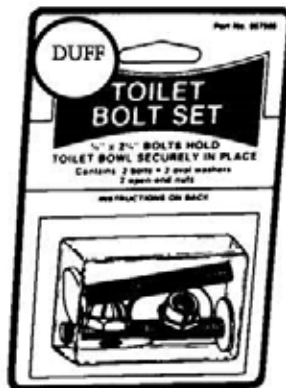

ALL BRASS Closet bolt Set. (PR)

SIZE	FIG. NO.	PRICE
1/4	15069	
5/16	91695	

STOP WASTING MONEY.
Call DUFF First!
610-275-4453



Brass Overflow Tube
 1" OD X 10" Long

FIG. NO.

18983

PVC Overflow Tube
 1" OD X 10" Long

FIG. NO.

18057

Duncan Fit All Arm Guide



FIG. NO.	PRICE
15064	

1/4 x 9 REFILL TUBE



FIG. NO.	PRICE
15054	

BOWL WAX

NO SEEP



No Seep 1. Fits 3" and 4" bowls only.

FIG. NO.	PRICE
14644	



No Seep 4. Urethane wax. 4" lines only - fits floor and most wall bowls.

FIG. NO.	PRICE
47159	

BOWL WAX



Bowl Wax 1. The standard bowl wax for floor bowls.

FIG. NO.	PRICE
14638	



Sponge Gasket. Wide flange, 1".

Size	Fig. No.	Price
3/8	14660	
9/16	14662	
3/4	14665	
1	14666	



Sponge Gasket.

FIG. NO.	SIZE
14656	3/4"
17793	1"



No Seep 2. Urethane w/ wax. Fits all wax bowls and carriers.

FIG. NO.	PRICE
14646	



No Seep 5. Urethane and wax. Extra thick - fits 3" and 4" wall or floor bowls.

FIG. NO.	PRICE
14648	



Bowl Wax 5. Urethane and wax. Extra thick. Fits 3 and 4" wall or floor bowls.

FIG. NO.	PRICE
37618	



No Seep 3. Extra thick. Fits 3" to 4" floor and most wall bowls.

FIG. NO.	PRICE
48802	



No Seep 10. Extra thick wax. For all 3" and 4" floor bowls.

FIG. NO.	PRICE
52330	



Bowl Wax 6. Urethane and wax. For 2" urinal outlet.

FIG. NO.	PRICE
14640	

ZURN GASKET FOR WALL HUNG CLOSETS

THEY'RE EASY TO INSTALL

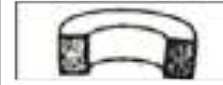

FIG. NO.	PRICE
14651	



American Standard Urinal Gasket.

FIG. NO.	PRICE
14654	



Kohler 2" urinal gasket

FIG. NO.	PRICE
14744	



Smith wall hung felt closet gasket.

FIG. NO.	PRICE
22403	

Residential and Commercial Applications

Strong and flexible to sustain a positive seal

Accommodates floors above the toilet flange up to 3/4"

Maintains a gas tight seal even when minor movement occurs

Fast, easy installation for a long-term solution.



FTS TECHNICAL SPECS

- No need for flange risers or stacked wax rings
- Ideal for in-floor radiant heat systems
- Impervious to mold and mildew
- Centers itself and the toilet to the drain
- Toilet can be removed and reinstalled with the same seal attached

The **FTS-3** Wax Free Toilet Seal

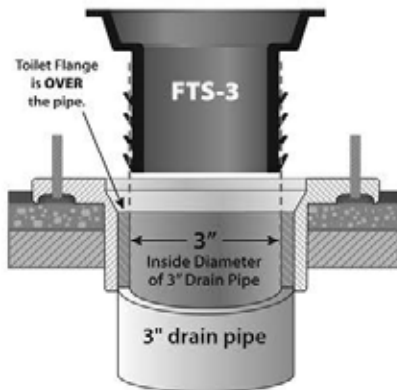

The **NEW FTS-4** Wax Free Toilet Seal

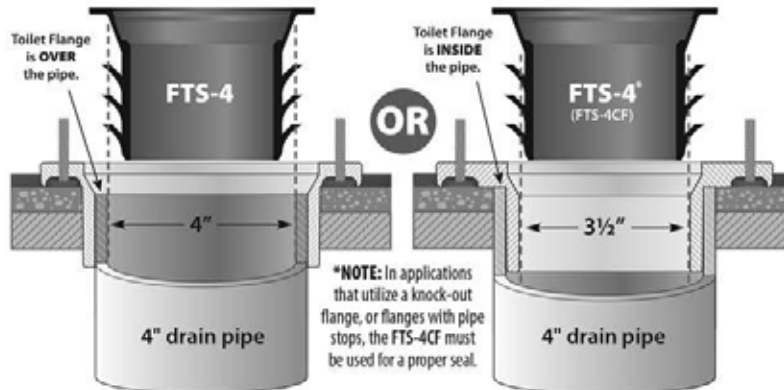

Applicable for Floor Mounts



FTS-4 is also Ideal for most 4" Closet Wall Carriers



FIG. NO.	TYPE
197157	FTS-3 (3")
197158	FTS-4 (4")
197159	FTS-4CF (4" x 3")

FLAPPERS

TRIPLE SEAL

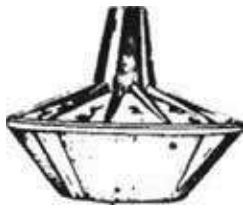

Triple Seal Tank Ball
2 1/2"

Fig. No. 14900

Triple Seal Tank Ball
3"

Fig. No. 14901



KORKY® PLUS™
Classic

- Premium 2" flapper with a larger ball design to stay open for older 5 and 7 gallon toilets
- Fits older style brass flush valves

Fig. No. 271534



KORKY® PLUS™
Universal Flapper

- Premium universal 2" flapper toilets before 1994

Fig. No. 50614

CRANE FLAPPER BALL

Replacement for Crane Flapper Ball

Fig. No. 14634

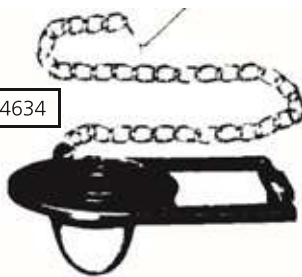

KOHLER

Kohler Silicone Coated Flapper, with chain and hook.

Fig. No. 47133

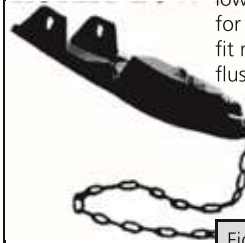

KORKY® LOW PRO

Specially designed for low boy toilets to allow for maximum flush. Will fit most conventional flush valves.

Fig. No. 49249

FLUSH FIX KIT

FLUIDMASTER - Easy installation, corrosion free, eliminates lift wires and guides.

Fig. No. 17720



BULL'S EYE SUPER FLAPPER

- Withstands harsh water
- Fits most flush valves
- Replaces flapper of #17720
- Snaps directly or adapts to 1" overflow tube



Fig. No. 44996

BLUE FLAPPER

Blue Flapper
Fits plastic flush valves

Fig. No. 51477



ELJER TOUCH FLUSH

Replacement for Touch Flush assembly unit. Includes bracket with chain, tankball and screw

Fig. No. 15012

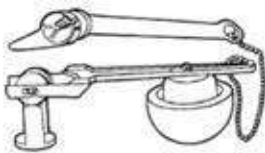

GERBER
STANDARD
2" Flapper

Fig. No. 261781



GERBER MAXWELL
3" Flapper

Fig. No. 312216



ELJER MUSHROOM TANK BALL

Eljer Titeseal Replacement Tank Ball

Fig. No. 14902

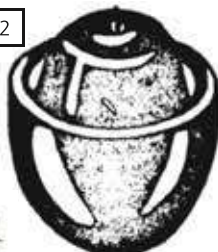

MANSFIELD
STANDARD
3" Flapper

Fig. No. 308640



GERBER STANDARD
3" Flapper

Fig. No. 216930



FLAPPERS

Fluidmaster.



555C Universal Flush Valve Repair Kit

- Universal Fit - Best for 1.28 - 3.5+GPF toilets
- Repair deteriorated flush valve seats without removing tank
- No messy glue, just peel and stick!

FIG. NO. 17720

Fluidmaster.



PRO53 Universal Heavy Duty Flapper

- Best for 3.5+ GPF toilets
- Built-in Microban® fights flapper breakdown due to bacteria on the flapper itself
- Fits on flush valves with or without mounting ear

FIG. NO. 44996

korky



Korky 3060BP Universal Toilet Flapper - 3"

- Adjusts to match performance of OEM flapper
- Universal design fits large 3" flush valves

FIG. NO. 27775

korky



Korky 92BP Max Flush Flapper

- Designed to give low flow toilets a more powerful flush
- Fits most plastic flush valves

FIG. NO. 27775



HFL 190 HydroForce Adjustable Flapper

- Replaces 2" 1.6 and 3.5 GPF flappers
- Float adjusts easily to help save water and includes a stainless steel chain

FIG. NO. 222467



BrassCraft BCT005 Hornet V Universal Toilet Flapper

- Universal Fit
- Black and Yellow
- Premium Engineered Vinyl
- Includes Plastic No-Rust, No-Kink Chain

FIG. NO. 187519



American Standard 7381129-200-007 Flapper

- Universal replacement flapper with float
- For 2" flush valves

FIG. NO. 244570



American Standard 738920-0070 Flapper

- 3-Inch flapper assembly
- For use with the American Standard Cadet 3 right height elongated toilet with slotted rim

FIG. NO. 246911



Kohler GP89825 2-Inch Flapper for Portrait

- Fits Portrait one-piece toilets
- Stainless steel chain

FIG. NO. 269673



Kohler GP1039444 3-1/4" Flapper Class 5

- One piece toilets with class five technology
- Cimarron Memoir

FIG. NO. 187519



Kohler GP1079948 Blue Flapper With Float

- Flapper with float for use with Wellworth, Iron Works, 2-piece Revival, Kathryn, Portrait, Leighton, Serif, Pinoir, Highline, and Devonshire toilets

FIG. NO. 244570



TOTO THU331S / THU175S

- Fits G-Max Toilet

FIG. NO. 232708



Fernco Wax-Free Toilet Seal

- Strong & flexible to sustain positive seal
- Ideal for wall carriers and floor mounts
- Made of flexible PVC

FIG. NO.	SIZE
197157	3"
197158	4"
197159	4" (3-1/2" opening)

Fluidmaster.

Fluidmaster PRO57

- Replacement Fluidmaster flush valve
- Fits all brands

FIG. NO. 168269



STOP WASTING MONEY.

**Call DUFF First!
610-275-4453**





Fluidmaster.

FLUIDMASTER PRO45 - Eliminates old-fashioned float balls and rod assemblies that corrode and leak. Easy to install. Permits simple adjustment of water level for most efficient flush. Fits most toilet tanks. Built in code approved backflow preventer.

FIG. NO.	PRICE
14989	

ONE PIECE CLOSET VALVE

Sheathed Vertical Float Valve, Rim Diverter, Flusher Fixer Kit, & Vinyl Hoses.

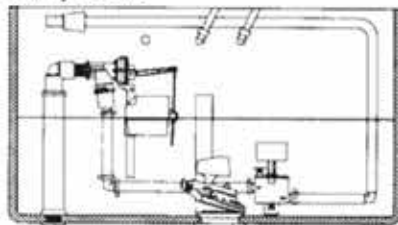

FITS KOHLER, AMERICAN STANDARD, CASE

256 - For the application of a one piece toilet with dry inlet tube system and one-piece toilet. Wet isolation tube.

FIG. NO.	PRICE
50491	

Compound Lever - All brass.

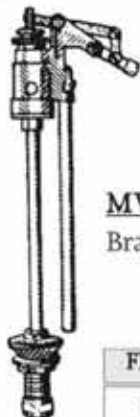

FIG. NO.	PRICE
15002	



Fillmaster - Adjustable ball cock. No float or rod needed. Completely corrosion proof. **ONE SIZE FITS ALL.** Excellent replacement for one piece closets and other extra low tanks.

FIG. NO.	PRICE
14992	



MVB Ballcock - All Brass. Regular shank.

FIG. NO.	PRICE
15001	

FLOATS



COPPER FLOAT

FIG. NO.	PRICE
15087	



PLASTIC FLOAT

FIG. NO.	PRICE
15085	

BALL COCK REPAIR



SEAL & FLIPPER ASSEMBLY - Repair kit for Fluidmaster ball-cocks.

FIG. NO.	PRICE
14990	



9" UPPER LIFT WIRE

FIG. NO.	PRICE
15063	



5" LOWER LIFT WIRE

FIG. NO.	PRICE
15060	



BRASS FLOAT ROD

FIG. NO.	PRICE
8"	15056
12"	15059

TOILET REPAIR

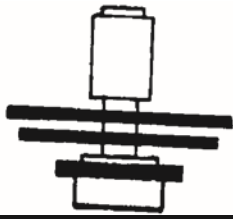

COAST Ball Cock Repair Kit

FIG. NO.	PRICE
15024	

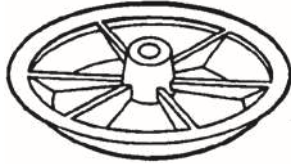

AMERICAN STANDARD REPLACEMENT DISCS Neoprene Anchored Spud

Snap-on

Screw-on

FIG. NO.	PRICE
14603	

FIG. NO.	PRICE
14601	



American Standard Ball Cock Repair Kit

FIG. NO.	PRICE
18056	

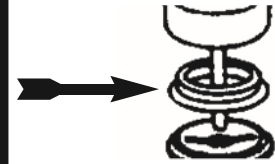

Seal Only for American Standard Flush Valve

FIG. NO.	PRICE
14608	

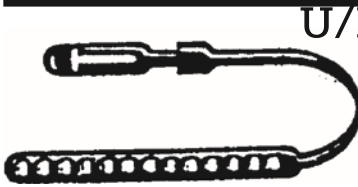

U/R Replacement Tank Strap

FIG. NO.	PRICE
42463	

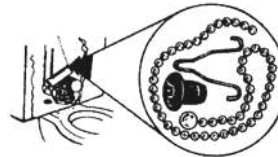

Repair Kit for American Standard Actuating Units

FIG. NO.	PRICE
33888	

U/R Tilt Valve

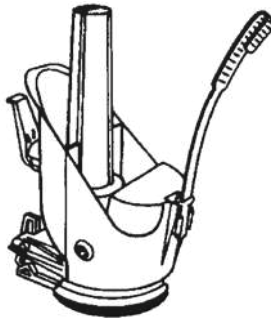

FIG. NO.	PRICE
15023	

AMERICAN STANDARD FLUSH VALVES

#4 Flushvalve



47086-07

FIG. NO.	PRICE
15014	

#6 Actuator



73380-07

FIG. NO.	PRICE
34747	

#5 Flushvalve



47089-07

FIG. NO.	PRICE
15017	

U/R Flush Valve Disk



FIG. NO.	PRICE
34496	

#4 Actuator



8162-07

FIG. NO.	PRICE
51714	



FAX YOUR ORDER TODAY.
610-279-6299

#5 Actuator

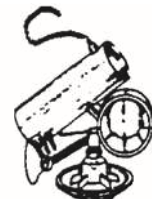

33642-07

FIG. NO.	PRICE
37855	

AMERICAN STANDARD REPLACEMENT BALLCOCK PISTON PLUNGER



FIG. NO.	PRICE
18366	

TOILET TANK TRIM



**MANSFIELD
FLUSH VALVE
#210**

FIG. NO.	PRICE
17605	

Flush Valve Repair Kit for #210



FIG. NO.	PRICE
42445	

**Flush Valve Repair Kit for
Mansfield #208 & #209**



FIG. NO.	PRICE
17606	



**Kohler Urinal Spud
with Flange**

FIG. NO.	PRICE
44284	



**Brass DOUGLAS Flush
Valve**

FIG. NO.	PRICE
15042	



**Plastic DOUGLAS
Flush Valve with Tank
Ball**

FIG. NO.	PRICE
15053	



**GERBER
3" Tank-to-Bowl
Gasket Kit**

FIG. NO.
262193



**Chrome Low
Down Tank 90
with
coupling**

FIG. NO.	PRICE
11712	

Brass Locknuts



SIZE	FIG. NO.	PRICE
1 1/4	12175	
2	12177	



**Flanged Spud
Washers**

SIZE	FIG. NO.	PRICE
1 X 3/4	14760	
1 1/4	14763	
1 1/2	14765	
2	14767	
2 X 1 1/2	14773	



**Galvanized Friction
Ring**

SIZE	FIG. NO.	PRICE
1 1/4	52517	
1 1/2	49394	
2	52519	



**Beveled Flush Valve
Washer 3" OD X
2 3/8" High**

FIG. NO.	PRICE
14743	

**TANK TO BOWL
GASKETS**



Universal	
FIG. NO.	PRICE
14744	



American Standard	
FIG. NO.	PRICE
14751	



Kohler	
FIG. NO.	TYPE
14753	Old Style
258400	New Stle



ELJER	
FIG. NO.	PRICE
37963	



GERBER	
FIG. NO.	PRICE
14747	

**DON'T SEE WHAT
YOU'RE LOOKING FOR?
CALL US!**

60-275-4453



**BRASS Closet
Spud (with
washer)**

SIZE	FIG. NO.	PRICE
1 1/4	15033	
1 1/2	15035	
2	15037	
2 x 1 1/4	15038	
2 x 1 1/2	15039	

URINAL SPUD

SIZE	FIG. NO.	PRICE
3/4	171640	
1 1/4 x 3/4	50485	

TANK LEVERS



GENERIC TANK LEVER

FIG. NO.	STYLE
15030	Metal
148059	All Brass

Deluxe Cast Brass Tank Lever

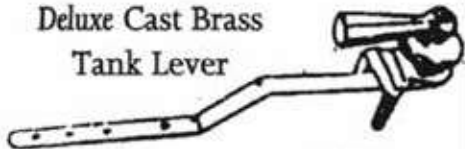

FIG. NO.	PRICE
15032	



KOHLER K9400 Tank Lever

FIG. NO.	PRICE
15019	

GERBER

PLASTIC TANK LEVER FOR GRAVITY UNITS
CHROMEOME



FIG. NO.	STYLE
239073	White
233175	Chrome

TOTO

THU068 TRIP LEVER FOR ST743S, CHROME



FIG. NO.	STYLE
129115	Chrome

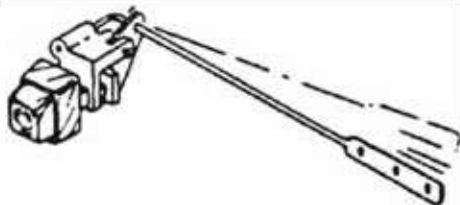

FRONT Push Tank Lever

FIG. NO.	PRICE
52550	



UNIVERSAL-RUNDLE type tank lever.

FIG. NO.	PRICE
52548	

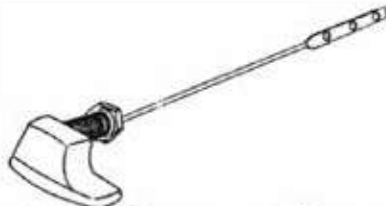

ELJER side mount tank lever

FIG. NO.	PRICE
52545	



MANSFIELD 10" Round Brass Offset Tank Lever.

FIG. NO.	TYPE
46855	Brass
17833	Plastic



KOHLER TANK TRIP LEVER w/spud & nut

FIG. NO.	PRICE
137167	

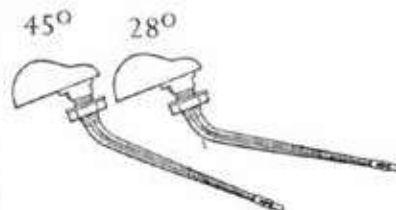

AMERICAN STANDARD 1.6 Cadet Tank Levers

FIG. NO.	PRICE
45°	51617
28°	80608

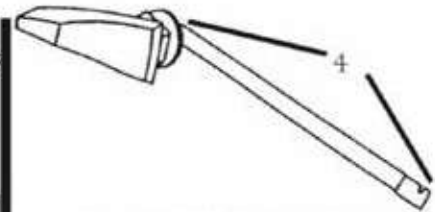

AMERICAN STANDARD 47147.0020A Cadet Tank Lever

FIG. NO.	PRICE
45416	

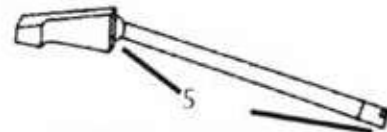

AMERICAN STANDARD Plebe Tank Lever

FIG. NO.	PRICE
43193	



FLEXIBLE TANK LEVER

8" long

Bends to fit most tank configurations

Front, side, neoangle

Trims to 4" or 6"

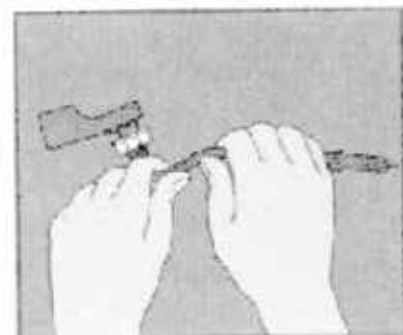

FIG. NO.	STYLE
77264	Chrome
232895	White

WE'RE WAITING FOR YOUR CALL! 610-275-4453



DEODORIZING URINAL SCREEN

- Large size - fits all urinals
- Eliminate clogged drains

FIG. NO.
52402

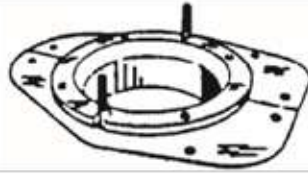

QUICK FLOOR EXPANSION PLATE

- Fits under floor flange to eliminate wobble caused by loose connection or rotten floor. Wide base allows screws to reach solid flooring. Closet flange attaches to expansion plate and floor.

FIG. NO.
44459

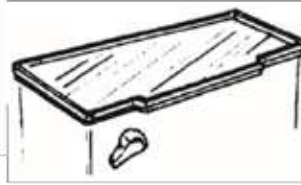

SAFETY TANK COVER

- White
- Adjustable
- Fits all tanks with OD of 21" X 7-3/8" or less

FIG. NO.
15084



HYDROSEAT TOILET FLANGE REPAIR

- One size fits all pipes, toilets and collars
- Easy to install

FIG. NO.
311405

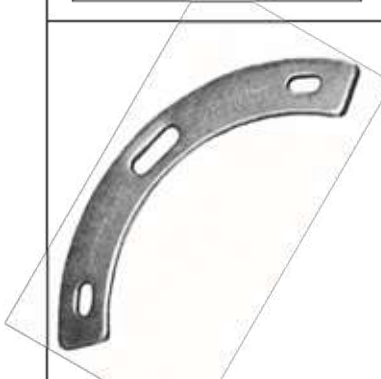

GAPPER CLOSET REPAIR FLANGE

FIG. NO.
7497

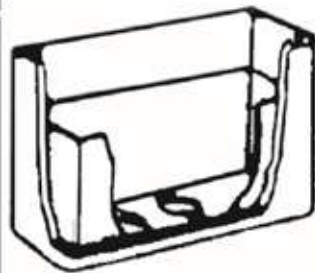

CLOSET TANK LINER

- Prevents condensation

FIG. NO.
18289



CLOSET FLANGE REPAIR RING

FIG. NO.
200202



TOILET BOLT CAPS

- White
- Round plastic
- Fits over 7/16" hex nuts
- Each

FIG. NO.
14614



SPANNER FLANGE

- Stops rocking toilet
- Repairs broken closet flanges

DUFF TIP:

Don't forget the closet bolts when you order the spanner flanges.

FIG. NO.
130324



REPLACEMENT PLASTIC TOILET TANK

- Perfect for any replacement needs in homes, apartments, housing units, bars, gas stations, parks, campgrounds, schools, industrial plants, etc.
- Furnished with antisiphon ballcock

FIG. NO.
15084

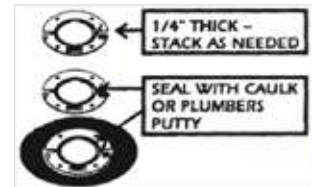
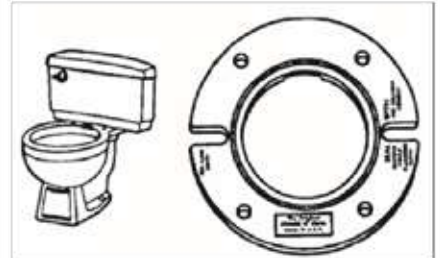

PVC CLOSET FLANGE SPACER KIT

FIG. NO.
15824

MISCELLANEOUS TOILET PARTS

COMMON FLUSHMATE PARTS

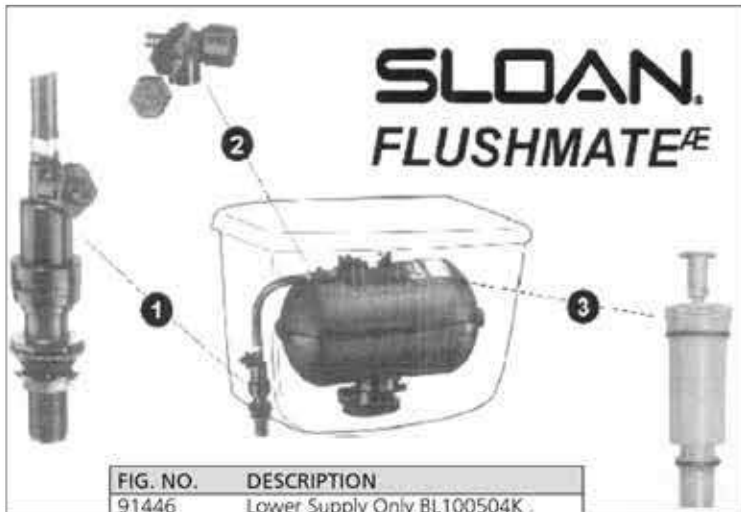

FIG. NO.	DESCRIPTION
91446	Lower Supply Only BL100504K
91445	Upper Supply New Style BU100505
68856	Cartridge C 100500K
107374	Lower Supply Assembly New Style with Upper Supply RK100100

PRESSURE-ASSIST TANK LEVERS



FIG. NO. _____
167289



FIG. NO. _____
127969



FIG. NO. _____
167289

DUFF TIP:

DUFF has complete Flushmate vessels in stock for most toilet brands — Call your DUFF rep today for cross-reference.



CARRIER NUTS AND WASHER SET (4 PACK)

FIG. NO. _____
36467

ABS ADJUST-TO-WALL COUPLING — 2-1/2" LONG

FIG. NO. _____
85355



EXTENDED CARRIER NUTS AND WASHER SET (4 PACK)

FIG. NO. _____
176357

ABS NIPPLE
8-1/4", 4-1/2" OD,
8 THREADS/INCH
W/KNOCKOUT CAP
• Fits most carriers

FIG. NO. _____
176357



See Page 224 for Wall-Hung Seals

TOILET PARTITIONS

OVER-HEAD BRACED TOILET PARTITIONS

Over-head braced, also known as headrail braced toilet partitions are the most popular style of bathroom partitions for many reasons. Price, strength, and ease of installation to name a few. No special floor or ceiling construction also makes this style appealing. Wood, concrete, light or heavy duty backing would all be acceptable fastening applications.



CEILING-HUNG TOILET PARTITIONS

Structure, structure, structure. This series must have structural backing and will only be as stable as the structural backing you have installed in the ceiling. This is typically the most desired series for a couple reasons. Saving the floor from unnecessary penetrations coupled with the ease of mopping the floor make this style a favorite for both architects and building maintenance personnel.



FLOOR-TO-CEILING TOILET PARTITIONS

The material in this style is considered the most expensive due to the fact that typically the most material is needed. With pilasters (front vertical support) stretching from the floor to ceiling it is thought that this style produces the most strength. Ceiling heights and material choices will also factor in, with the strength of it's end result.



FLOOR MOUNTED TOILET PARTITIONS

Floor mount toilet partitions are intended for bathrooms with high ceilings to give a spacious look. They provide clean lines and require a good floor backing to keep partitions stable.



PARTITIONS ARE AVAILABLE IN SEVERAL MATERIALS:

- PLASTIC LAMINATE
- SOLID PLASTIC (HDPE/POLY)
- BAKED ENAMEL/ METAL (MOST POPULAR)
 - Tan Available for Next-Day Shipping
- STAINLESS STEEL
- PHENOLIC

Call your DUFF Rep for color choices and layout expertise
610-275-4453

**ALL HARDWARE AND FASTENINGS FOR A COMPLETE INSTALLATION ARE INCLUDED!
 NEED PARTITIONS IN A HURRY?**

SPECIFY

- Right or left corner
- Inswing or outswing door
- Exact room measurements
- Overhead-braced
- Ceiling hung
- Floor to-ceiling
- Floor mounted



PARTITION HARDWARE

SLIDE LATCH

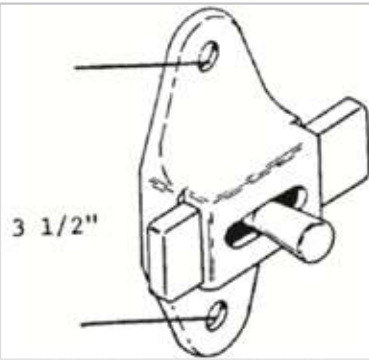

FIG. NO.	PRICE
43844	

SLIDE LATCH

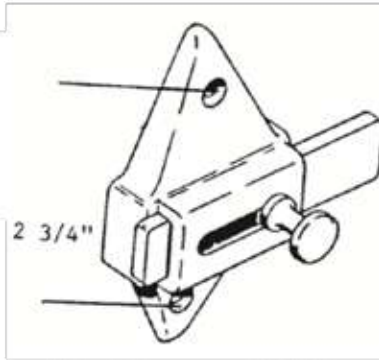

FIG. NO.	PRICE
43842	

CONCEALED LATCH

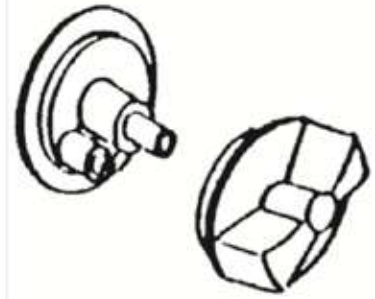
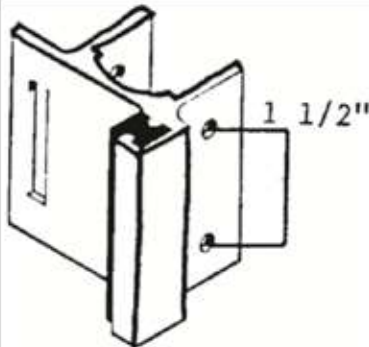

FIG. NO.	PRICE
8253	

STRIKER & KEEPER



FOR 1/4" STEEL PILASTER

FIG. NO.	PRICE
43820	

STRIKER & KEEPER FOR ANY TYPE PILASTER

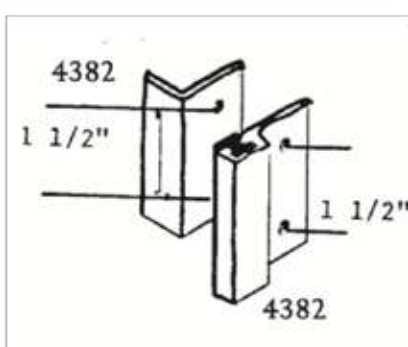

INSWING STRIKER AND KEEPER

FIG. NO.	PRICE
43825	
43827	

ADA CONCEALED LATCH

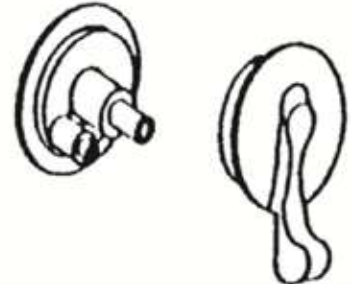

FIG. NO.	PRICE
180139	

FITTINGS AND PARTS AVAILABLE ARE TOO NUMEROUS TO CATALOG. PLEASE SEND FOR THE DUFF PARTITION HARDWARE CATALOG!

CONCEALED DOOR LOCK

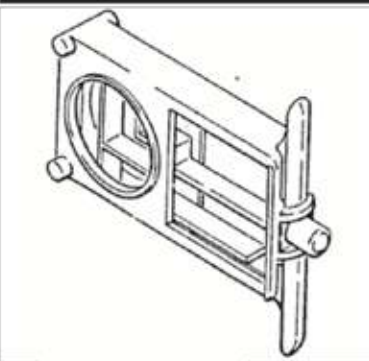
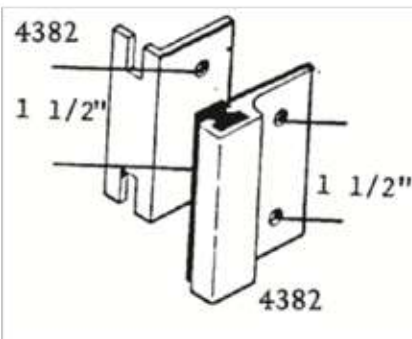

FIG. NO.	PRICE
73476	

STRIKER & KEEPER FOR ANY TYPE PILASTER



OUTSWING STRIKER AND KEEPER

FIG. NO.	PRICE
43826	
43827	

STRIKER & KEEPER FOR CONCEALED LATCH

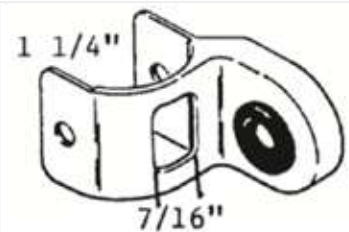

FITS FIG. NO. 8253 & 60738 !

FIG. NO.	PRICE
43823	

BOTTOM HINGE BRACKET

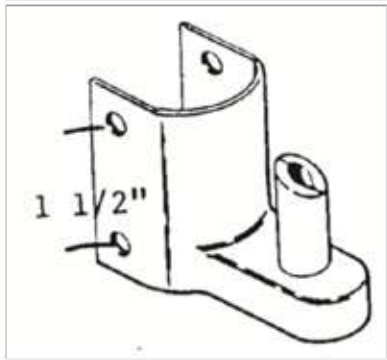

FIG. NO.	PRICE
43829	

PARTITION HARDWARE

TOP HINGE BRACKET

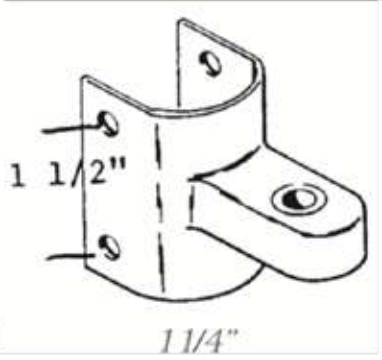
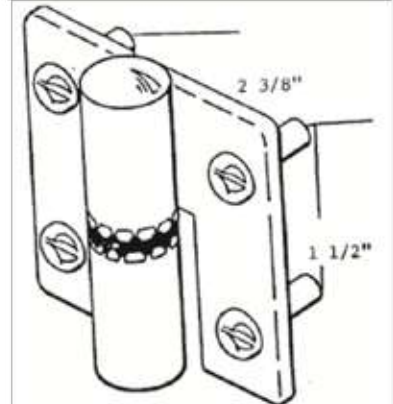

FIG. NO.	PRICE
43828	

SURFACE GRAVITY HINGE



FOR RIGHT HAND OUTSWING OR LEFT HAND INSWING

FIG. NO.	PRICE
43836	

FOR RIGHT HAND INSWING OR LEFT HAND OUTSWING

FIG. NO.	PRICE
43837	

SQUARE BOTTOM HINGE BRACKET

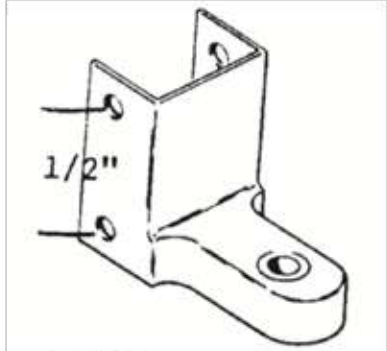

FIG. NO.	PRICE
43833	

SQUARE TOP HINGE BRACKET

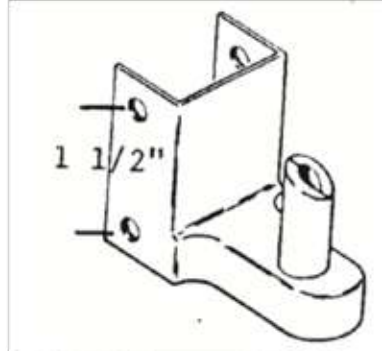

FIG. NO.	PRICE
43830	

BUMPER HOOK

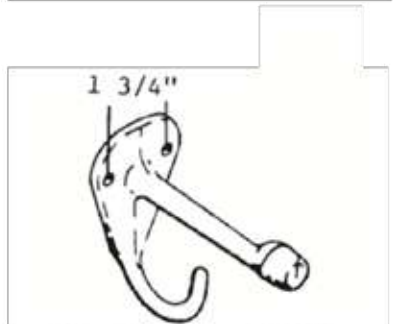
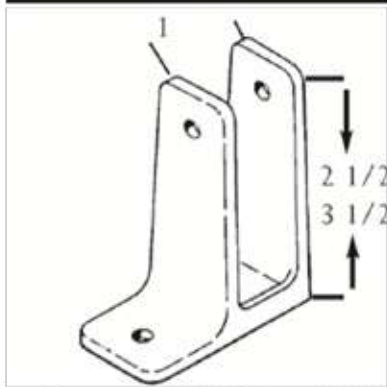

FIG. NO.	PRICE
43848	

ONE EAR WALL BRACKET



SIZE	FIG. NO.	PRICE
2 1/2	43789	
3 1/2	43793	

TWO EAR WALL BRACKET

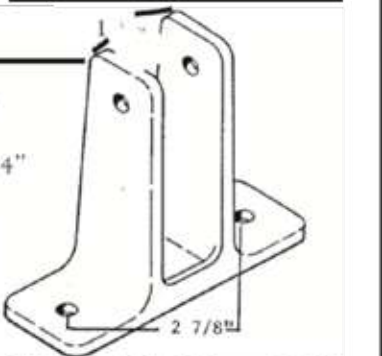

SIZE	FIG. NO.	PRICE
2 1/2	43782	
3 1/2	68340	
1 3/4	65878	

FOR ONE-WAY SCREWDRIVER AND ONE-WAY SCREWS, PLEASE SEE PAGE 236!

DUFF COMPANY STOCKS WASHROOM ACCESSORIES

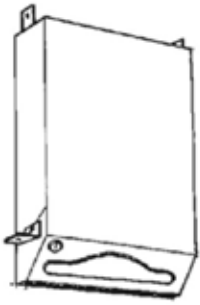

Towel Dispenser

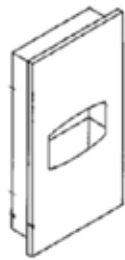

*Towel Dispenser/
Waste Receptacle*

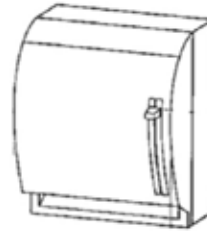

Towel Dispenser

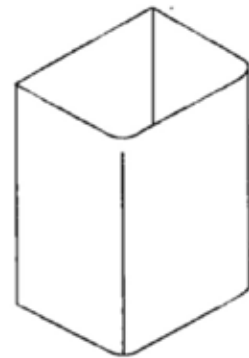

Waste Receptacle



*Sanitary Napkin/ Tampon
Vendor*

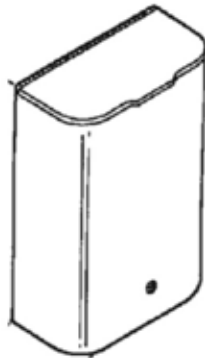

*Sanitary Napkin Disposal
Unit*

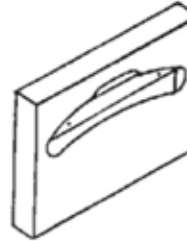

Seat Cover Dispenser

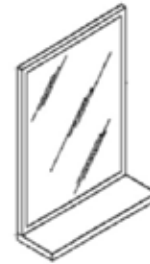

Mirror Shelf

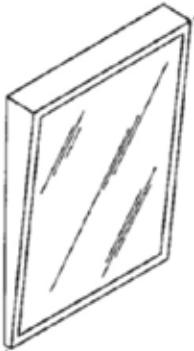

Fixed Tilt Mirror

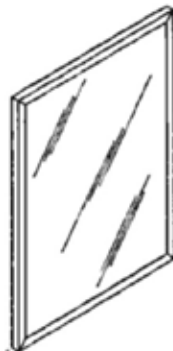

Mirror



Adjustable Tilt Mirror



XLERATOR® HAND DRYERS







- 120 volts (Other voltages available)
- 10-15 second dry time
- 80% less energy than conventional hand dryers
- 95% Cost Savings vs. Paper Towels
- Virtually Maintenance-Free

FIG. NO.	FINISH
242253	White
Many other finishes available	

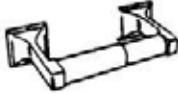
DUFFNOTE:

DUFF has a complete selection of washroom accessories — Call or email your DUFF rep today for your washroom needs.
610-275-4453
info@duffco.com

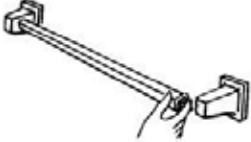
WASH ROOM ACCESSORIES.

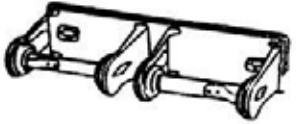
 <p>Tumbler and Toothbrush Holder</p> <table border="1"> <thead> <tr> <th>FIG. NO.</th> <th>PRICE</th> </tr> </thead> <tbody> <tr> <td>8349</td> <td></td> </tr> </tbody> </table>	FIG. NO.	PRICE	8349		 <p>Paper Holder</p> <table border="1"> <thead> <tr> <th>FIG. NO.</th> <th>PRICE</th> </tr> </thead> <tbody> <tr> <td>8436</td> <td></td> </tr> </tbody> </table>	FIG. NO.	PRICE	8436		 <p>Soap Holder</p> <table border="1"> <thead> <tr> <th>FIG. NO.</th> <th>PRICE</th> </tr> </thead> <tbody> <tr> <td>8370</td> <td></td> </tr> </tbody> </table>	FIG. NO.	PRICE	8370		 <p>Double Hook</p> <table border="1"> <thead> <tr> <th>FIG. NO.</th> <th>PRICE</th> </tr> </thead> <tbody> <tr> <td>8461</td> <td></td> </tr> </tbody> </table>	FIG. NO.	PRICE	8461									
FIG. NO.	PRICE																										
8349																											
FIG. NO.	PRICE																										
8436																											
FIG. NO.	PRICE																										
8370																											
FIG. NO.	PRICE																										
8461																											
 <p>Towel Bar</p> <table border="1"> <thead> <tr> <th>SIZE</th> <th>FIG. NO.</th> <th>PRICE</th> </tr> </thead> <tbody> <tr> <td>18"</td> <td>8497</td> <td></td> </tr> <tr> <td>24"</td> <td>8506</td> <td></td> </tr> <tr> <td>36"</td> <td>8514</td> <td></td> </tr> </tbody> </table>	SIZE	FIG. NO.	PRICE	18"	8497		24"	8506		36"	8514		 <p>Replacement Towel Bar - 24" with spring ends - cut to length.</p> <table border="1"> <thead> <tr> <th>FIG. NO.</th> <th>PRICE</th> </tr> </thead> <tbody> <tr> <td>19753</td> <td></td> </tr> </tbody> </table>	FIG. NO.	PRICE	19753		 <p>Commercial single paper holder.</p> <table border="1"> <thead> <tr> <th>FIG. NO.</th> <th>PRICE</th> </tr> </thead> <tbody> <tr> <td>8294</td> <td></td> </tr> </tbody> </table>	FIG. NO.	PRICE	8294		 <p>Commercial double paper holder.</p> <table border="1"> <thead> <tr> <th>FIG. NO.</th> <th>PRICE</th> </tr> </thead> <tbody> <tr> <td>8310</td> <td></td> </tr> </tbody> </table>	FIG. NO.	PRICE	8310	
SIZE	FIG. NO.	PRICE																									
18"	8497																										
24"	8506																										
36"	8514																										
FIG. NO.	PRICE																										
19753																											
FIG. NO.	PRICE																										
8294																											
FIG. NO.	PRICE																										
8310																											

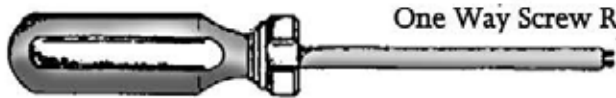

One Way Screw Removal Tool -

for toilet partition work.

For #6-8 Screws

FIG. NO.
44045

For #8-10 Screws

FIG. NO.
43910

For #12-14 Screws

FIG. NO.
43911



One way screws.

Available in 1", 1-1/4" and 1-1/2"



BASIN LAVATORY LEGS

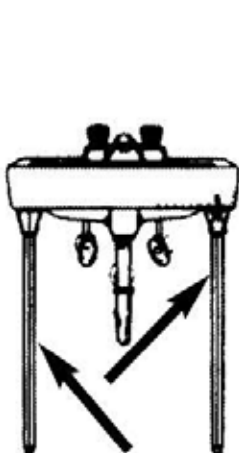

28" Chrome lavatory legs. Universal fit for china, steel, or iron enamel.

FIG. NO.	PRICE
15334	



LET DUFF HELP YOU COMPLY WITH ALL YOUR ADA REGULATIONS!

610-275-4453

GRAB BARS

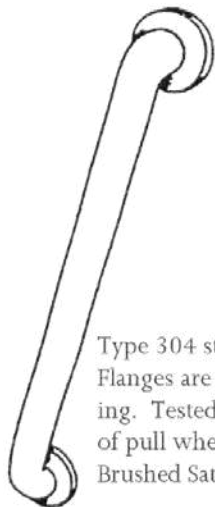

Type 304 stainless steel tubing.
Flanges are heliarc welded to tubing. Tested to withstand 1000 LBS of pull when properly installed. Brushed Satin.



SIZE	FIG. NO.	PRICE
12"	17660	
18"	45417	
24"	17662	
30"	45418	
36"	17663	



MSA-13 REAR MOUNTED
Grab bar is 1 1/2" diameter x 24" with 1/2" thick closure plate welded to bar. Other sizes are available.
MSA-14 FRONT MOUNTED
Same as above but exposed mount

ALL GRAB BARS ARE AVAILABLE WITH EXPOSED OR CONCEALED FLANGES.

20 DIFFERENT FINISHES AVAILABLE!

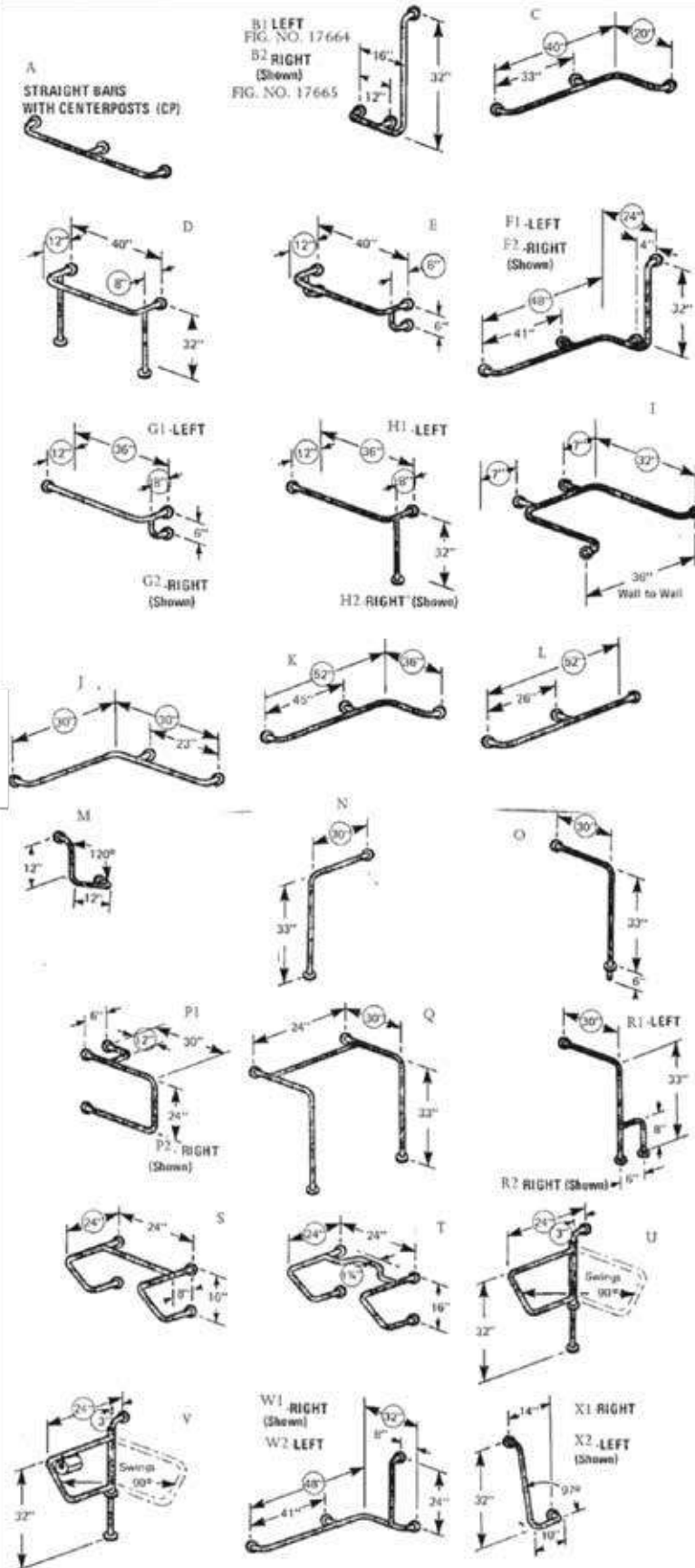



TUB AND SHOWER UNITS

FOR STUD POCKET INSTALLATION
FOR NEW HOMES OR REMODELING
ALL MOLDED FROM VIKRELL MATERIAL

EASY TO CLEAN, LIGHTLY PEBBLED BOTTOM ENHANCES SAFETY AND CONVENIENCE
SNAP TOGETHER CONSTRUCTION ELIMINATES BOLTS, NUTS, WRENCHES AND CAULKING!
10 YEAR CONSUMER - 3 YEAR COMMERCIAL - LIMITED WARRANTY

ENSEMBLE™

60" X 30" MEDLEY™ BATH/SHOWER

- Modular design allows it to be moved around corners and through doorways with ease.
- Clean, contemporary design with ample shelving.
- Compression molded from solid Vikrell® material.
- Product includes 60" x 30" Medley™ Bath/Shower Wall Set and 30" Bath

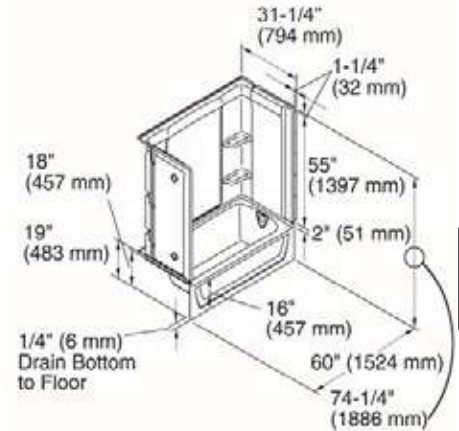
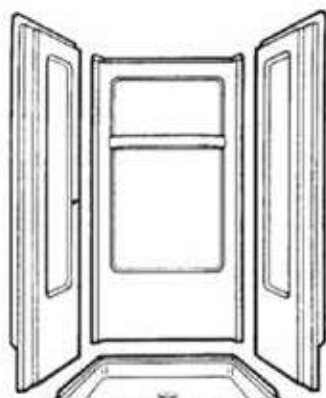
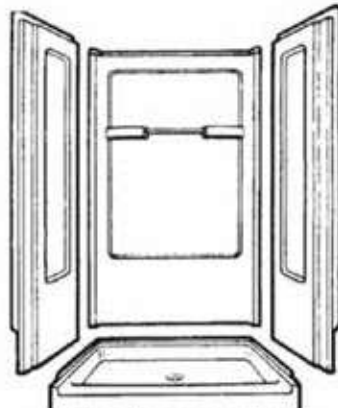

FIG NO.	TYPE
11371	LH
115134	RH

STALL SHOWERS



32"x34 1/2"W X 73 1/4"H



36"x34"W X 73 1/4"H

STALL SHOWER compression molded from Vikrell material. Lightly textured swirl-gloss finish. Easy to clean - never needs waxing. Lightly pebbled slip-resistant bottom enhances user safety and convenience. 4-piece design provides installation flexibility. Components move easily and thru doorways as narrow as 22". Snap-together feature eliminates need for bolts, nuts, wrenches or caulking. 60" x 30" 120 LB. WHITE. Colors available!

32"			36"		
DESCR	FIG. NO.	PRICE	DESCR	FIG. NO.	PRICE
WHITE	44842		WHITE	44844	
COLOR	44843		COLOR	44845	

TUB ONLY

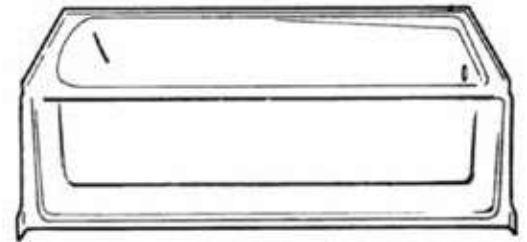

5' TUB ONLY compression molded from Vikrell material. Lightly textured swirl-gloss finish. Easy to clean - never needs waxing.

Lightly pebbled slip-resistant bottom enhances user safety and convenience.

60" x 30 1/2" 56 LB. WHITE.

Colors available!

Shipped with protective liner!

DESCR	FIG. NO.	PRICE
WHITE	44852	
COLOR	44853	

TUB & SHOWER

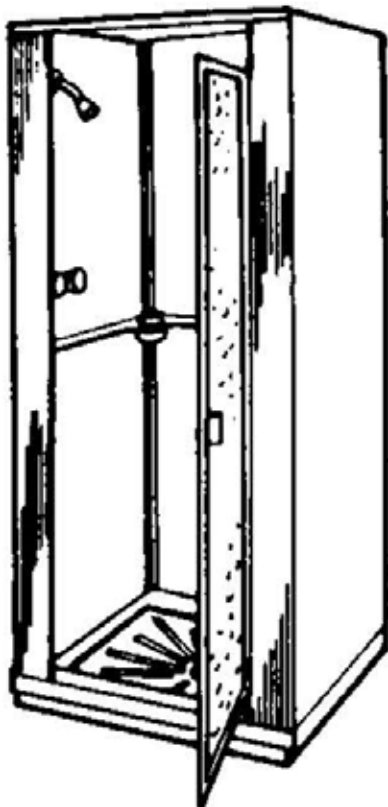

FIBERGLASS DURASTALL Shower Stall

A complete shower stall in one package that assembles easily and looks great in a finished or unfinished basement — freestanding — no studs required!

SIZE	ENCL	BASE
32x32x75	Curtain	Std.
30x30x73	Curtain	Std.



32" SQUARE TILE BASE with PVC drain assembly and seal single threshold

FIG. NO.	PRICE
8040	

RECTANGULAR FIBERGLASS BASE

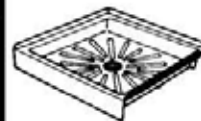

with PVC drain assembly and seal. Single threshold

COLOR	SIZE
White	32X48
White	32X60

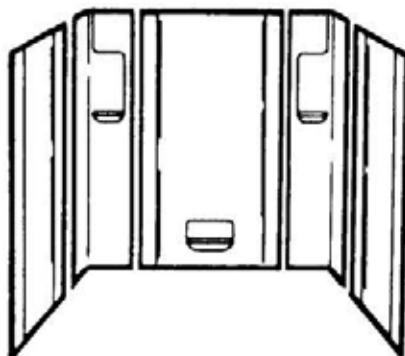

Fiberglass Tubwall Enclosure - for tub size 57" to 62" wide, 29" to 32" deep. 5-piece compression-molded fiberglass unit with high glass, smooth surface. Kit includes: one back panel with molded-in soap dish, two right angle corner panels with molded-in shampoo shelves, two flat side panels, two apron strips, pressure-sensitive tape applied to all outer edges, two tubes of adhesive, one tube of caulk, and complete installation instructions.

FIG. NO.	PRICE
14690	

NEO-ANGLE White corner angled threshold base with PVC drain assembly and seal.



SIZE	FIG. NO.	PRICE
36X36	29539	
36X38	—	

Fiberglass Tubwall Enclosure - for tub size 30" x 60" or smaller. 3-piece compression-molded fiberglass unit with high glass, smooth surface. Kit includes: one back panel with molded-in soap dish, two end panels, factory installed pressure-sensitive tape, two tubes of adhesive, one tube of caulk, and complete installation instructions.

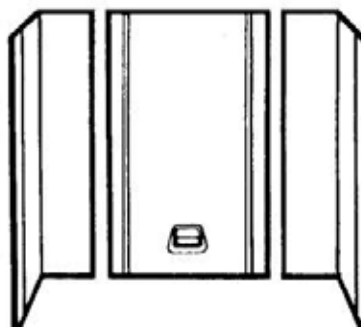

FIG. NO.	PRICE
14682	

DRAIN GASKET

Seals drain pipe with flexible gasket



FIG. NO.	PRICE
2" IP or PVC	52354
2" Copper	49110

TUB & SHOWER

FIBERGLASS TUB & SHOWER WALLS FOR REMODELING
 20 YEAR LIMITED WARRANTY
 WATER & MOLD RESISTANT - EASY TO INSTALL.
 COLORS AVAILABLE!

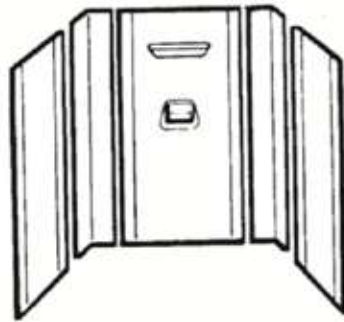

Fiberglass showerwall enclosure. For base 36"x36" or smaller. 5 piece compression-molded fiberglass unit with high gloss, smooth surface. 5 piece unit with soap dish and shampoo shelf. WHITE.

FIG. NO. PRICE

FIG. NO.	PRICE
14684	

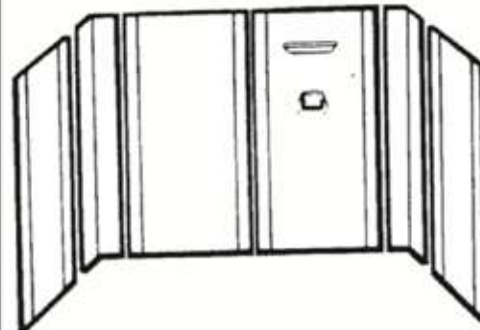

Fiberglass showerwall enclosure. For base 30"x36" up to 36"x60". 6 piece unit with soap dish and shampoo shelf. WHITE.

FIG. NO.	PRICE
14688	

SHOWER TOWER

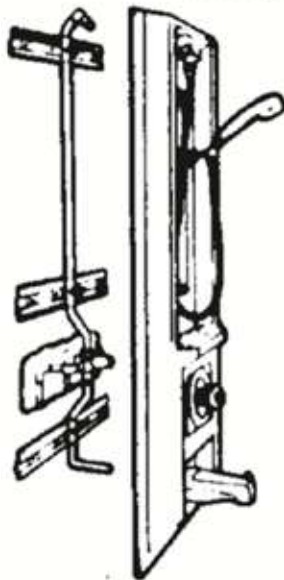

One-water tested copper plumbing tree with blender valve and threaded connections for water hook-up, three special screws and anchors, one press-molded fiberglass housing with foam strips installed on back of sides for water tightness and all materials necessary for installation. Copper tubing outlet and tub spout included. Includes either a standard shower head or hand-held shower assembly with glide rail pre-installed.

**GLASS
 SHOWER DOORS
 AVAILABLE
 FROM
 BASCO**



TM1-S

TM2-H

SM1-S

SM2-H

ORDER BY
 MODEL
 NUMBER!

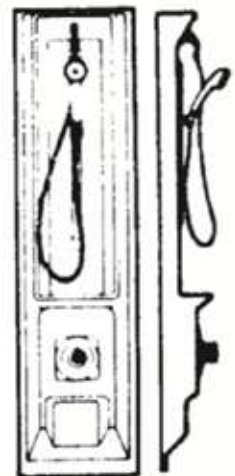
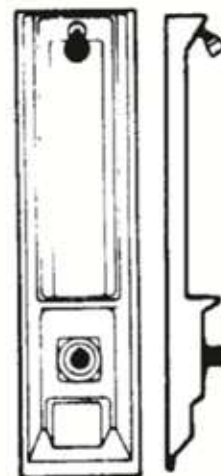
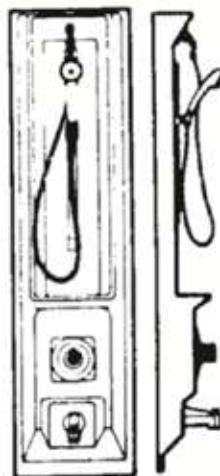
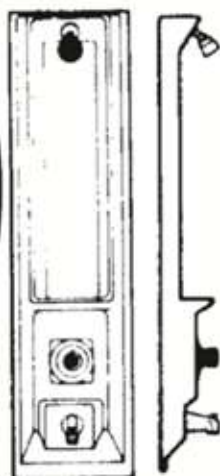

SHOWER HEADS

CB Chatham Brass



Chrome plated, solid brass flow control shower head.

FIG. NO.	PRICE
14832	

CB Chatham Brass



Chrome plated brass flow control shower head with pilfer proof feature (set screw).

FIG. NO.	PRICE
14833	

CB Chatham Brass



Vandal-Proof institutional shower head

FIG. NO.	PRICE
14830	

SPEAKMAN



The Anystream® Classic features engineered compact design to pack a punch. With 4 powerful jets, it delivers 32 infinitely adjustable full-coverage sprays

- 32 spray channels
- 2.5 GPM flow control

FIG. NO.	PRICE
17618	

SPEAKMAN



The Anystream® Icon 48 Spray Showerhead features updated Speakman technology with refined, solid-brass components, modern contours and an assortment of attractive finishes.

- 48 spray channels
- Brass construction

FIG. NO.	PRICE
17617	

SPEAKMAN



Featured in Double Tree Hotels, Atlantis Casino Resort and Sheraton Hotels and Resorts. The Anystream® Hotel 50 Spray Showerhead has a wide range of invigorating full-flow sprays in a compact design.

- 50 powerful full-body sprays
- 8 center pulsating jets
- 3-1/2" face diameter
- 2.5 GPM flow control

FIG. NO.	PRICE
158770	

MOEN

Buy it for looks. Buy it for life.™

EASY CLEAN® XL 6300 Series

- (Showerhead only)
- Various finishes
 - Nonmetallic spray face
 - Nonmetallic shell
 - Single spray
 - Showerhead is limited to 2.5 gpm
 - EP suffix models are 1.75 gpm
 - EP15 suffix models are 1.5 gpm



FIG NO	FINISH	GPM
249923	CHROME	1.75
308046	BRUSHED CHROME	2.5



SLOAN Valve AC-51 2-1/2" Water Saving Shower Head

FIG NO
54277



Chrome Plated Adjustable Plastic Massage Shower Head

FIG NO
81011



DELTA FAUCET COMPANY

LOWFLOW SHOWERHEAD

- Full spray function
- 1.5 GPM @ 80 PSI

FIG NO
234236



Adjustable shower head, chrome plated brass.

Chatham Brass

FIG. NO.	PRICE
38920	



Adjustable shower head with pilfer proof feature (set screw), chrome plated brass.

FIG. NO.	PRICE
14828	



2" ball joint shower head - chrome plated

FIG. NO.	PRICE
14823	

HYDRA MASSAGE SHOWER HEAD



- Deluxe Chrome
- Removable flow restrictor to 2.50 GPM at 80 PSI
- 3 Spray functions- Pulsating, Massage, Regular Spray or Combination Spray!

FIG. NO.	PRICE
78827	



Shower volume control valve.

FIG. NO.	PRICE
14838	



2" multi-spray (adjustable) showerhead.

Chrome plated brass.

FIG. NO.	PRICE
14824	

SHOWER ACCESSORIES

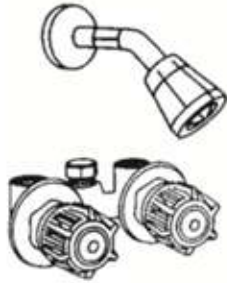

Stall Shower Valve.
3 3/8" centers.

FIG. NO.	PRICE
14768	



2 GPM Flow Restrictor.
3 variable orifices. Slips into threaded collar of shower head, cone pointing up. 2GPM @ 15 to 125 PSI.

FIG. NO.	PRICE
14837	

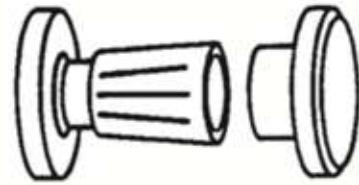

Jiffy Shower Rod Flanges.
Chrome plated, easy adjustment for tool-free installation of shower rod.

FIG. NO.	PRICE
14761	



Shower Arm

SIZE	FIG. NO.	PRICE
1/2 X 6	14739	
1/2 X 8	51253	

SMITTY PLATE REMODEL
3 1/2" OPENING, STAINLESS STEEL

- Stainless Steel construction
- 3-1/2" opening
- Used to replace 8" center valve with single lever valve

AVAILABLE IN OTHER FINISHES



FIG. NO.	PRICE
7856	



Deluxe shower arm escutcheon with set screw.

FIG. NO.	PRICE
14741	

PREVENT WATER DAMAGE!

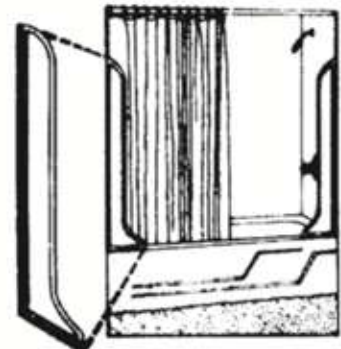

Shower Mate. Keeps water from escaping around ends of shower curtain. Shelf adhesive strips, white polystyrene.

FIG. NO.	PRICE
19216	

SHOWER ACCESSORIES



PR CP Shower Rod
Flanges

FIG. NO.	PRICE
14762	

DUFF's got
the solutions!
email us at
info@duffco.com



Curtain
Pins.
(Nickel
Plated)



FIG. NO.	PRICE
14766	

PR Jumbo Shower Bar
Flange. Chrome plated.

FIG. NO.	PRICE
14764	



5 FT Aluminum Shower Rod With
Flanges

FIG. NO.	PRICE
14749	



Aluminum Shower Corner Rod with
Flanges

FIG. NO.	PRICE
14752	



Add-A-Shower with bathcock. Chrome
Plated. FOR TUB WITH LEGS.

FIG. NO.	PRICE
14724	

Replacement
shower valve only



FIG. NO.	PRICE
14727	

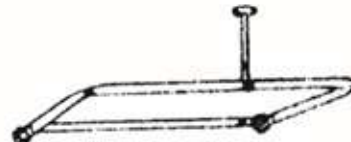

5FT "D" Shower Rod with Flange



Shower Head
Extension. Raise
the level of
shower head.
Chrome plated
brass pipe. 1/2"
M X 1/2" M.



Utility Shower.
Rough brass finish.
Wall-Mounted.

FIG. NO.	PRICE
38724	



CEILING
SUPPORT

Chrome
plated
24"



Ceiling Support
Flange. Regular
1/8" Thread. With
mounting screws.

FIG. NO.	PRICE
14737	

24" Ceiling Support
Rod.

FIG. NO.	PRICE
14730	



1" Loop Ceiling
Support

FIG. NO.	PRICE
14732	

3/4" Loop
Ceiling Support

FIG. NO.	PRICE
14734	

HANDHELD SHOWERS



DELTA
FAUCET COMPANY

DELTA CLASSIC ADJUSTABLE SPRAY HANDHELD SHOWER

- Easy-turn spray dial
- Manufactured using metal and engineering grade plastics
- 2.5 gpm @ 80 psi

FIG. NO.
102144



Full Body Spray



DELTA
FAUCET COMPANY

DELTA SINGLE FUNCTION HANDHELD SHOWER

- Designed to deliver 2.5 gpm @ 80 psi
- Full Body Spray

FIG. NO.	TYPE
15364	White w/o push-button
15365	White with push-button
249273	Chrome with push-button



MOEN
Buy it for looks. Buy it for life.™

MOEN 8349 Single Function Handheld Shower

- Handheld shower
- High impact chrome plated plastic
- Quick cleaning rubber nozzles
- Single-function spray pattern
- Designed to deliver 1.5 gpm

FIG NO
219439



MOEN
Buy it for looks. Buy it for life.™

4-Function Massaging Handshower w/Slide bar

- 69" double interlock spiral hose (metal)
- 30" slide bar with push button height selection
- 4-function: massage, vigorous, full and combination

FIG. NO.	TYPE	MODEL
168433	Chrome	3669
265393	Brushed Nickel	3667



MOEN
Buy it for looks. Buy it for life.™

Handheld shower with Slide Bar/Grab Bar

- Contains: hand-held shower, stainless steel, 1 1/2" dia. slide bar grab bar, drop ell, vacuum breaker, 69" metal hose and mounting hardware
- Push button operation
- 2.5 gpm maximum at 80 psi

FIG NO
201746



DELTA
FAUCET COMPANY

DELTA CLASSIC FIXED WALL-MOUNT HANDHELD SHOWER, White

- 60" Ultraflex hose
- 2.5 gpm @ 80 psi

FIG NO	TYPE
98128	White



Full Body Spray



DELTA
FAUCET COMPANY

DELTA CLASSIC FIXED WALL-MOUNT HANDHELD SHOWER, Chrome

- 60" Ultraflex hose
- 2.5 gpm @ 80 psi

FIG NO	TYPE
235383	Chrome



Full Body Spray



Massage



Crossing Full Spray



Crossing Full Spray w/Massage

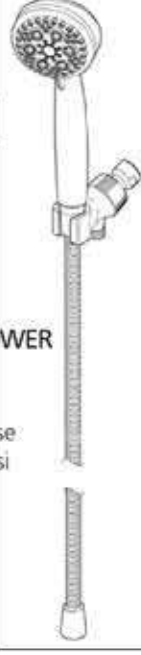

DELTA
FAUCET COMPANY

DELTA HIGH-VELOCITY HANDHELD SHOWER with Hose and Arm Mount

- 60" Ultraflex hose
- 2.5 gpm @ 80 psi

FIG NO
315680



Full Body Spray



Fast Massage

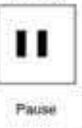

Pause



Full Spray w/Massage



High-Efficiency Spray



DELTA WALL BAR

- Delta universal adjustable wall bar, chrome
- Concealed installation screws



FIG. NO.
118320



DELTA WALL BAR

- Delta universal adjustable glide wall bar, chrome
- Concealed installation screws

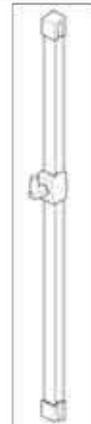

FIG. NO.
172107

DELTA WALL MOUNT

- Mounts HandShower to wall
- Accommodates conical hose nuts

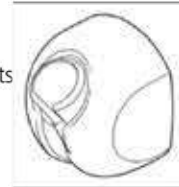

FIG. NO.	TRIM
308275	Chrome
164946	White

DELTA WALL MOUNT

- Adjustable Shower Arm mount
- 1/2IPS female inlet
- 1/2IPS male outlet



FIG. NO.	TRIM
182360	Chrome

DELTA ALL-BRASS PIN WALL MOUNT FOR HAND SHOWER



FIG. NO.	TRIM
15366	Chrome

DELTA PIN MOUNT SWIVEL CONNECTOR FOR HAND SHOWER - 90°



FIG. NO.	TRIM
15368	Chrome

DELTA PIN MOUNT SWIVEL CONNECTOR FOR HAND SHOWER - 45°



FIG. NO.	TRIM
260175	Chrome

DELTA SHOWER ARM DIVERTER FOR HAND SHOWER



FIG. NO.	TRIM
15359	Chrome

DELTA 3-WAY SHOWER ARM DIVERTER WITH HAND SHOWER MOUNT



FIG. NO.	TRIM
315681	Chrome

DELTA 3-WAY PUSH-BUTTON SHOWER ARM DIVERTER



FIG. NO.	TRIM
175777	Chrome

ADJUSTABLE WALL MOUNT

- Fits hex or conical nuts
- Glues or screws to the wall

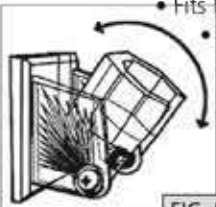

FIG. NO.	TRIM
15361	CLEAR

DELTA SHOWER ARM PIN MOUNT



FIG. NO.	TRIM
38101	Chrome

DELTA REPLACEMENT ROUND SLIDE

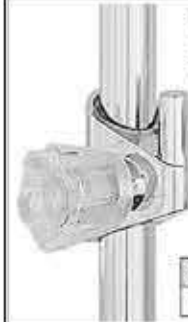

FIG. NO.	TRIM
118321	Chrome



DELTA VACUUM BREAKER



FIG. NO.	TRIM
110719	Chrome



DELTA WALL SUPPLY ELBOW FOR HAND SHOWER



FIG. NO.	TRIM
224637	Chrome

DELTA REPLACEMENT SQUARE SLIDE



FIG. NO.	TRIM
179181	Chrome

TUB SPOUTS

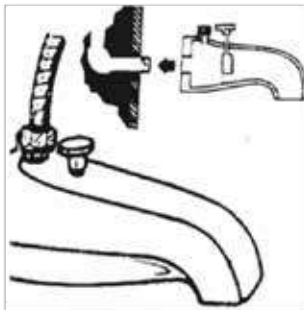

Diverter with 1/2" MPT top shower

FIG. NO.	PRICE
44871	

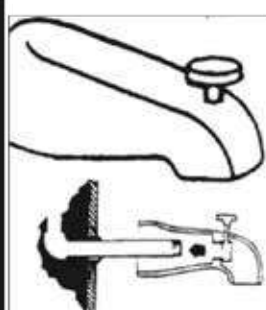

Diverter with 1/2" FPT at the nose

FIG. NO.	PRICE
47332	

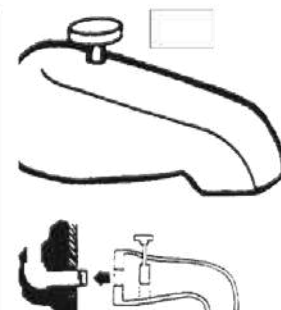

Diverter with 3/4" x 1/2" bushing at back

FIG. NO.	PRICE
14770	

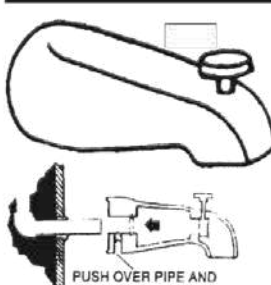

Slip-type Diverter

PUSH OVER PIPE AND TIGHTEN SET SCREW

FIG. NO.	PRICE
43543	

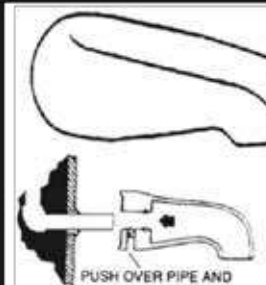

Slip-type spout over rim.

PUSH OVER PIPE AND TIGHTEN SET SCREW

FIG. NO.	PRICE
47333	

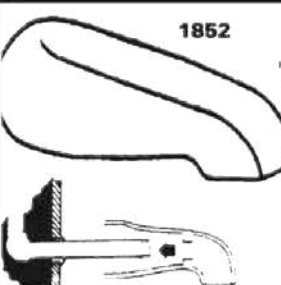

1852 Female Tub Spout

FIG. NO.	PRICE
14769	

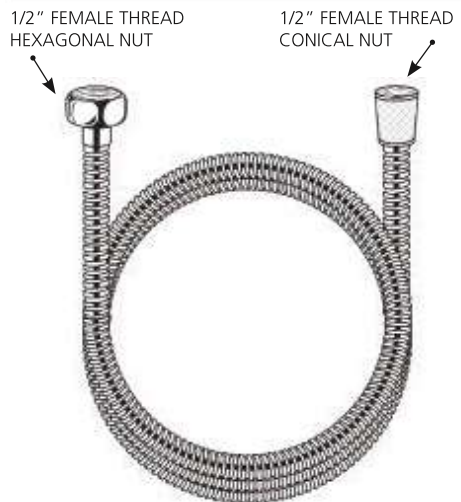

1/2" FEMALE THREAD HEXAGONAL NUT

1/2" FEMALE THREAD CONICAL NUT

STAINLESS STEEL FIXED LENGTH HOSE

FIG NO.	LENGTH	BRAND
15354	60"	Delta
15355	71"	Jaclo
15358	96"	Jaclo

STAINLESS STEEL ULTRAFLEX STRETCHABLE HOSE

FIG NO.	LENGTH	BRAND
128703	60"-82"	Delta
239325	69"-92"	Delta

TRIP PLATES/TRIP LEVERS



Blank Trip Plate

FIG. NO.	PRICE
49312	



Lever Trip Plate

FIG. NO.	PRICE
15331	

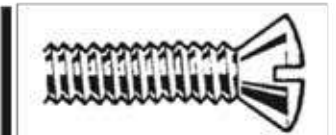

Trip Plate Screw (each)

FIG. NO.	PRICE
47209	



1/2" FEMALE THREAD HEXAGONAL NUT

1/2" FEMALE THREAD CONICAL NUT

WHITE / CHROME RIBBON HOSE

FIG. NO.	LENGTH	BRAND
96158	84"	Delta
OTHER LENGTHS AVAILABLE		

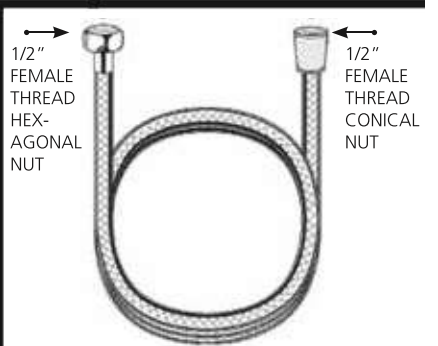

1/2" FEMALE THREAD HEXAGONAL NUT

1/2" FEMALE THREAD CONICAL NUT

REINFORCED VINYL HOSE

FIG. NO.	LENGTH	BRAND
130901	69"	Delta
OTHER LENGTHS AVAILABLE		

ELKAY

WATER COOLERS

 **Halsey Taylor**

Bottle Filling Station with Single ADA Cooler

- Bottle Filler features sanitary no-touch sensor activation with automatic 20-second shut-off time
- Green Ticker™ counts the quantity of bottles saved from waste
- Quick Fill Rate
- Features 3000 gallon capacity WaterSentry® Plus filtration with visual LED replacement Filter Monitor
- Available as retrofit or stand alone — bottle filler only!



FIG. NO.	MFR	FINISH
312586	Elkay	SS
236659	Elkay	Grey
241052	Halsey/Taylor	Grey

Wall-Mount Single ADA Cooler

- Our most popular cooler series
- Front and side easy-touch pushbars



FIG. NO.	MFR	FINISH
201721	Elkay	Grey
167809	Halsey Taylor	SS

Halsey Taylor Barrier-Free (Voyager) Cooler

- HT's most economical ADA-compliant cooler



FIG. NO.	MFR	FINISH
152230	Halsey Taylor	Grey

Wall-Mount ADA Cooler (Top Chiller)

- Front and side easy-touch pushbars



FIG. NO.	MFR	FINISH
265259	Elkay	grey
75371	Halsey Taylor	grey

Wall-Mount Cooler

- Traditional classic style
- Push button activation



FIG. NO.	MFR	FINISH
--	Elkay	Grey
75082	Halsey Taylor	Grey

Compact Wall-Mount Cooler

- Push button activation



FIG. NO.	MFR	FINISH
--	Elkay	Grey
77454	Halsey Taylor	Grey

Floor-Mount Cooler

- Push button activation



FIG. NO.	MFR	FINISH
---	Elkay	Grey
78247	Halsey Taylor	Grey

Compact Floor-Mount Cooler

- Push button activation



FIG. NO.	MFR	FINISH
---	Elkay	Grey
44870	Halsey Taylor	Grey

Wall-Mount Semi-Recessed Cooler

- Simulated semi-recessed design
- Push button activation



FIG. NO.	MFR	FINISH
---	Elkay	Grey
75204	Halsey Taylor	Grey

DUFFNOTE:

Many coolers available with hot water dispenser option, higher GPH output and other finishes

In-wall and surface-mount bottle fillers available separately.

We also carry Sunroc, Oasis, Haws, Acorn and many other brands!

610-275-4453
info@duffco.com

ELKAY

WATER COOLERS & FOUNTAINS

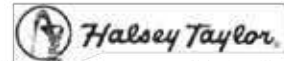

Wall-Mount Bi-Level ADA Cooler
 • Front and side easy-touch pushbars
 • Available with bottle-filler stations



FIG. NO.	MFR	FINISH
167699	Elkay	grey

Versatile Wal-Mount Bi-Level ADA Cooler

- Front and side easy-touch pushbars
- Allows for standard high-left/low-right or alternate low-left/high-right installation



FIG. NO.	MFR	FINISH
261671	Elkay	grey

Stainless Steel Single Fountain

- Feature softly rounded corners and a contoured basin designed to provide a splash-resistant surface



FIG. NO.	MFR	FINISH
248818	Elkay	Standard
243383	Halsey Taylor	ADA

Central Brass Wall-Mount Drinking Fountain

- Self-close lever handle
- 3/8" FPT bottom drain outlet
- Great for outdoor applications like playgrounds!



FIG. NO.
8578

DUFFNOTE:



Call for Point-of-Use Bottleless Water Coolers, available in a variety of sizes & options!

610-275-4453
 info@duffco.com

Remote Chiller (8gph)



FIG. NO.	MFR
233595	Elkay
213146	Halsey Taylor
other brands and models available	

WATER COOLER & FOUNTAIN REPLACEMENT PARTS

Elkay / Halsey Taylor Replacement Filter



FIG. NO.	PKG/QTY
234046	1
—	3
—	12
—	24
—	48

Central Brass Bubbler Head (all brass)

- 3/8" FIP inlet



FIG. NO.
8580

Central Brass Push-Button Bubbler Head (all brass)

- 3/8" FIP inlet
- Less flange



FIG. NO.
8575

Central Brass Push-Button Bubbler Head (all brass)

- 3/8" FIP inlet
- With flange



FIG. NO.
8574

Central Brass Push-Button Bubbler Head (all brass)

- 1/2" MIP shank
- With flange



FIG. NO.
25044

Sunroc/Haws Bubbler Head (all brass)

- 3/8" FIP inlet
- Uses traditional bubbler cartridge



FIG. NO.
46831

Oasis/EBCO Bubbler Dial-A-Drink Assy.

- Protective rubber bubbler guard



FIG. NO.
17548

Sunroc Cobra Bubbler Head



FIG. NO.
80610

Elkay / Halsey Taylor Bubbler (plastic)

Also available vandal-proof (Mfr. No. 45851C)



FIG. NO.
182106

Elkay Bubbler

- Protective rubber bubbler guard



FIG. NO.
147669

For additional information call: 610-275-4453 or Fax: 610-279-6299
 Please call for current prices.

Don't Become a News Story!



Duff Co. is proud to announce a point-of-use **LEAD REDUCTION FILTER KIT**. Great for kitchens, water fountains, vending equipment. Kit is easy to install, and priced affordably.

System filters out lead, VOC's, cysts, extra-fine sediment, bad taste & odor, and chlorine taste & odor from drinking water. Cartridge should be changed approx. every 3 months, depending on water quality and usage.



**Fig. No.
334403**

Specifications:

- .5 Micron Rating
- Dimensions: 2 7/8" x 9 3/4"
- Capacity Based on Contaminant (see below)
- Temp Range: 40-165F
- Flow Rate: 0.5 - 1 GPM
- NSF Standard 42 Tested and Certified
- Removes chlorine taste & odor, cysts, lead, VOC, MTBE and extra fine sediment
- Removes 99.95% of Cryptosporidium and Giardia Cysts

Capacity for Removal Per Contaminant:

- Chlorine Taste & Odor 20,000 Gallons
- VOC & Cysts 600 Gallons
- MTBE 500 Gallons

Call or email for
special pricing

Complete Lead Filter Kit*

***What's included:**

- 2.5" x 10" replaceable advanced multi-media cartridge
- Clear housing (3/4" FIP connections)
- Wall bracket
- Wrench

PLEASE CONTACT YOUR DUFF SALES REP FOR SPECIAL APPLICATIONS

610.275.4453

info@duffco.com





Column shower. Hydrostatically tested to 150 PSI. One set of supply connections required. Preassembled, complete with drain fitting.

SPECIFICATIONS: Materials - all exposed parts are type 304 stainless steel polished to a #4 finish or polished chrome-plated brass, valve manifold is cast-brass. Drain fitting is cast iron and supply inlets are copper turbing.
CONTACT US FOR HELP WITH YOUR SPECIFIC APPLICATIONS!

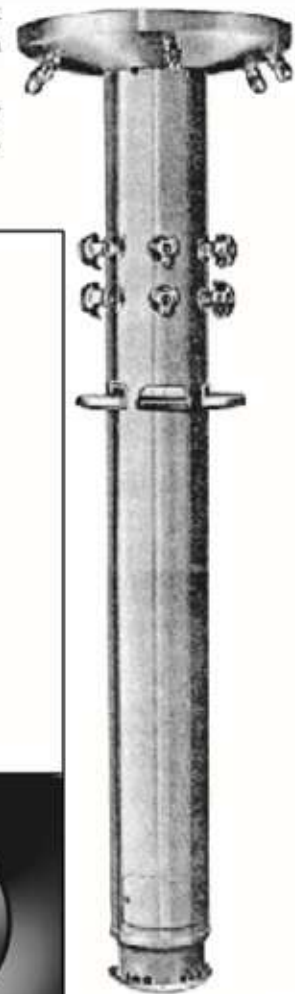

COMBINATION CHECK VALVE

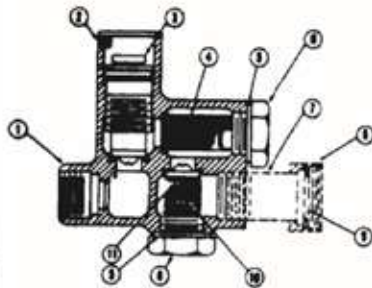

DESCR	FIG. NO.	PRICE
BRASS VALVE ONLY	67467	
REPAIR KIT	63703	

FOOTVALVE

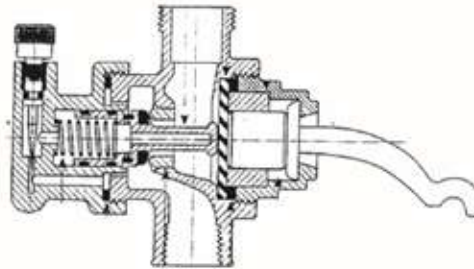

DESCR	FIG. NO.	PRICE
COMPLETE FOOT VALVE	38936	
REBUILD KIT	15126	

MANUAL MIXING VALVE

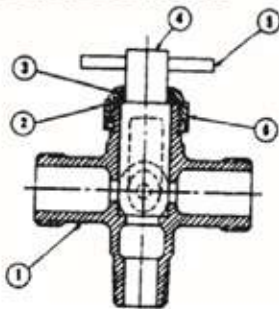

DESCR	FIG. NO.	PRICE
BRASS VALVE With Tail Pieces	133131	

OPERATING LEVER

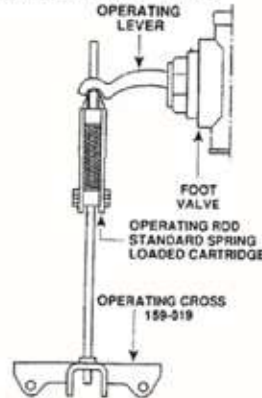

BRADTROL CARTRIDGE



FIG. NO.
304710

ANGLE VOLUME CONTROL VALVE

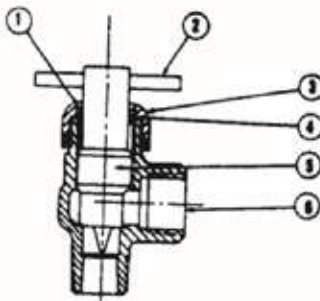

DESCR	FIG. NO.	PRICE
BRASS VALVE ONLY	128644	

DUFF DIFFERS

ASK US HOW ...

DUFF DELIVERS



SAFETY / EMERGENCY EYEWASHES & SHOWERS

Guardian Safety Station with Eye/Face Wash



FIG. NO.	DESCRIPTION
217566	Stainless bowl
308442	Plastic bowl

Guardian Pedestal-Mounted Eyewash



FIG. NO.	DESCRIPTION
243057	Plastic bowl
119183	Stainless bowl w/ foot activation

Guardian Wall-Mounted Eyewash



FIG. NO.	DESCRIPTION
119180	Plastic bowl

Guardian Emergency Shower, Horizontally-Mounted



FIG. NO.	DESCRIPTION
309870	Plastic Shower Head

Guardian Deck-Mounted Eyewash



FIG. NO.	DESCRIPTION
104154	Right-hand (pictured)
104155	Left-hand

Haws Wall-Mounted Eyewash



FIG. NO.	DESCRIPTION
31158	Plastic bowl

Guardian Replacement Parts

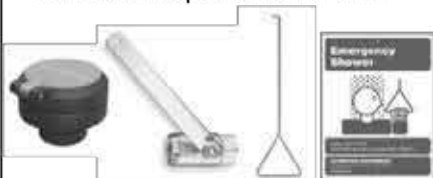

FIG. NO.	DESCRIPTION
167023	Spray head with dust cover
—	Stay-open drench ball valve
—	Pull rod, 29" length
—	Emergency shower sign

Guardian Deck-Mounted Eyewash / Drench Hose Unit



FIG. NO.	DESCRIPTION
229819	Deck-mounted unit only
224762	With backflow preventer

Drench Hose Unit (Single Head)



FIG. NO.	DESCRIPTION
271150	Guardian
31130	Haws

Guardian Eyewash / Drench Hose Unit



FIG. NO.	DESCRIPTION
249392	With wall bracket and supply elbow

Guardian Faucet-Mounted Eyewash



FIG. NO.	DESCRIPTION
44595	

Guardian Faucet-Mounted Eyewash



FIG. NO.	DESCRIPTION
66355	

Haws eyePOD Faucet-Mounted Eyewash



FIG. NO.	DESCRIPTION
—	Haws 7620 Thermostatic 100° shut-off

Speakman Eyewash/Faucet Combo



FIG. NO.	DESCRIPTION
—	SEF-1800-CA Widespread faucet with integral eyewash unit (mixing valve available)

HydroGuard XP Series Emergency Tempering Valves with Internal Cold Water Bypass



Call or email for your application today



1947



1960



1974



1981



1997

Since 1947, Duff Co. has been your source when you need it now . . . or don't know how. Plumbing and heating supplies, pumps, water conditioning equipment and systems, and multifamily housing supplies – Duff Co. is now your one-stop source.

PLUMBING & HEATING

My father, Dick Duffine, founded Duff Co. in 1947 to serve the commercial and residential plumber. More than 65 years later, those tradesmen remain important to us. While Duff Co. began as a supplier of specialty plumbing items, we now stock a vast inventory of products, materials and tools for the maintenance departments of office buildings, school districts and colleges, apartment communities, hospitals, factories and other large facilities.

PUMPS

Submersible, effluent, chemical feed, booster, circulator and well pumps – whatever your situation demands, Duff Co. can supply the pump and the accessories. We offer a wide range of pumps for a wide range of applications, whether for residential, commercial or industrial uses.

WATER CONDITIONING EQUIPMENT AND SYSTEMS

Duff Water Conditioning, a division of Duff Co., manufactures residential, commercial and industrial water conditioning products and systems. DWC can supply your softeners, filters, neutralizers, chemical feed pumps and all related parts. DWC also provides training on the latest advances and products in water conditioning. We support our water conditioning professionals with a knowledgeable internal tech support group and sales team, each member with years of hands-on experience.

MULTIFAMILY HOUSING SUPPLIES

We have taken our one-source concept directly to multifamily housing managers. Duff Co. now offers a wide range of products and supplies for maintenance

and renovation – including cabinets and countertops – and to help maintain the comfort of your tenants. From cleaning supplies, light bulbs & electrical parts to light fixtures, mini blinds and ceiling fans, Duff Co. is truly the one source for your supply and equipment needs. We offer several lines of quality kitchen cabinets and bath vanities. Our all-wood cabinets come in a variety of styles and finishes with a choice of countertop type and color. We even provide a design service to help

you serve your customers better. This means Duff Co. can provide everything you need for the kitchens, cabinets, plumbing and maintenance of your facility.

Duff Co. team members are available and on-call for emergency service, 24 hours a day, 365 days a year. We take our business as serious as yours. Our team, where the average tenure exceeds 20 years, enjoys the personal relationships with our customers. Duff Co.'s reputation for a broad product line, excellent service, fast delivery and strong family values makes Duff Co. differ from other companies.



L to R: Alex Duffine, Michael Genkin, Geoff Duffine

A lot of things have changed since 1947, including Duff Co. We have expanded our service and product offering. The third generation has joined the family business.

What hasn't changed is Duff Co.'s commitment to serving our customers. If you need it now, or if you don't know how, you should call Duff Co. today and speak with any of our knowledgeable specialists. You will get the solutions you need at competitive prices.

Welcome to Duff Co.,

COMPLETE FAUCET REPAIR KITS

TUB & SHOWER REBUILD KITS

These faucet repair kits feature replacement parts for most brand name tub and shower faucets. Conveniently packaged with all of the necessary parts, each kit is self-contained, making it a smart choice for both Contractor and Do-It-Yourselfers.

Installation instructions, along with helpful tools, and required tools are featured on every package.



ITEM #	DESCRIPTION
# 225526	Central* Tub, Old Style
# 119476	Central* Tub, New Style
# 124799	Delta* Tub Single Lever2
# 119475	Gerber* Tub 3- Handle
#124797	Price-Pfister* Verve Tub-3-Handle
# 85002	Price-Pfister* Windsor Tub- 3-Handle
# 124798	Sayco* Tub- 3 Handle
# 124616	Sterling* Tub 3- Handle

DUFFNOTE:

Kits shown are DUFF Best Sellers!
Many other manufacturers' kits available!

610-275-4453

info@duffco.com



LAVATORY & KITCHEN REBUILD KITS

These faucet repair kits feature replacement parts for most brand name kitchen and lavatory faucets. Conveniently packaged with all of the necessary parts, each kit is self-contained, making it a smart choice for both Contractor and Do-It-Yourselfer. Installation instructions, along with helpful tools, and required tools are featured on every package.



ITEM #	DESCRIPTION
# 124801	Central* Lav
# 124807	Delta* Single Handle Lav
# 124796	Gerber* Lav
# 124802	Price-Pfister* Verve Lav
# 85005	Price-Pfister* Marquis Lav
# 85022	Sayco* Lav
# 124805	Sterling* Lav

HYDRANT KITS

CALL DUFF FOR ALL YOUR HYDRANT REPAIR PARTS FOR ALL BRANDS!

AFM



Mansfield

NIBCO

PRIER



MIFAB
Our Reputation is Stainless

WATTS

JOSAM

WADE



ZURN



ZURN KEY



FIG. NO. 17997

JR SMITH KEY



FIG. NO. 29207

4-WAY KEY



FIG. NO. 17491

SPEAKMAN
PERFECT STEM 2"



FIG. NO.	TYPE
131513	Cold
131514	Hot

SPEAKMAN PARTS & ACCESSORIES
PERFECT STEM 2-5/16



FIG. NO.	TYPE
56906	Cold
45394	Hot

SPEAKMAN
PERFECT STEM 3-1/4"



FIG. NO.	TYPE
131505	Cold
131508	Hot

SLOW-CLOSE STEM



FIG. NO. 68314

SENTINEL BLOCK ASSEMBLY



FIG. NO. 131481

ADAPTER AERATOR

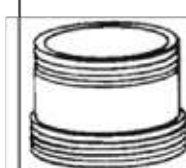

FIG. NO. 50509

STEMS & SEATS

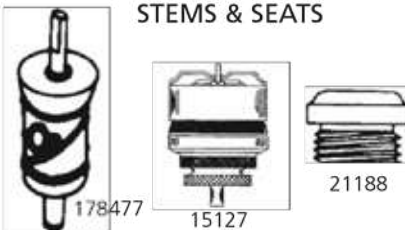
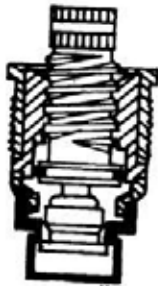

FIG. NO.	DESCRIPTION
178477	Colortemp Cartridge
15127	Piston for closet/urinal w/1-1/2" or 1/14" spud connection
21188	Seat 7/16 x 27

AMERICAN STANDARD AND KOHLER FAUCET REPAIRS

AMERICAN STANDARD



American Standard Aquaseal stem.

FIG. NO.	PRICE
HOT 16910	
COLD 16919	

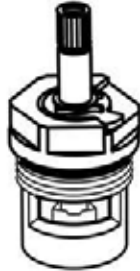

American Standard Ceramic Stem

TYPE	FIG. NO.
HOT/COLD	11730



American Standard Stem Unit

FIG. NO.	PRICE
HOT 16875	
COLD 16878	



AQUASEAL

FIG. NO.	PRICE
14778	

AMERICAN STANDARD Neoprene washer (top hat washer)



AMERICAN STANDARD

Heritage Lav or Sink Handles. Chrome plated canopy, includes screws & buttons.

FIG. NO.	PRICE
HOT 48084	
COLD 19146	

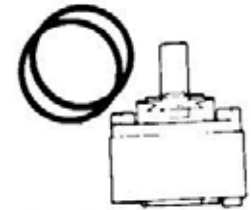

American Standard Aquarian Cartridge

FIG. NO.	PRICE
15121	

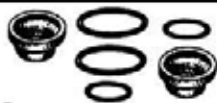

AMERICAN STANDARD Aqua Seal Repair Kit.

FIG. NO.	PRICE
19757	



American Standard small "CADET" Aqua Seal Gasket

FIG. NO.	PRICE
48897	

American Standard Cadet Stem.



FIG. NO.	PRICE
HOT 48895	
COLD 48896	



AMERICAN STANDARD 4" WING HANDLES

FIG. NO.	PRICE
COLD 50775	
HOT 50774	



American Standard Aqua Seal Seat.

FIG. NO.	PRICE
22066	

KOHLER

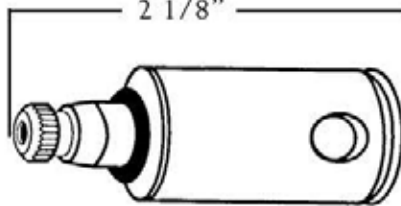

VALVET Kohler Stem Unit

FIG. NO.	TYPE
HOT 17218	Plastic Plunger
COLD 17219	Plastic Plunger

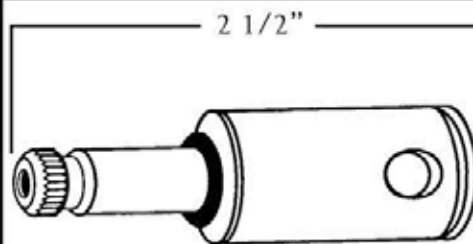

VALVET Kohler Stem Unit

FIG. NO.	TYPE
HOT 17216	Plastic Plunger
COLD 17217	Plastic Plunger
HOT 125421	Brass Plunger
COLD 125422	Brass Plunger

WATERSAVER

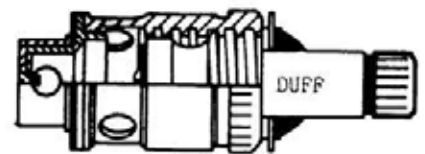

Watersaver Stem

FIG. NO.	PRICE
HOT 40840	
COLD 40839	

STERLING PARTS

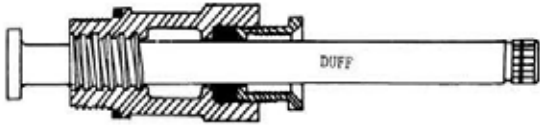

STERLING SHOWER STEM UNIT

FIG. NO.	PRICE
10356	

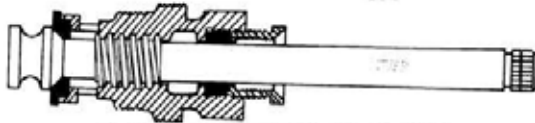

STERLING DIVERTER STEM

FIG. NO.	PRICE
10359	

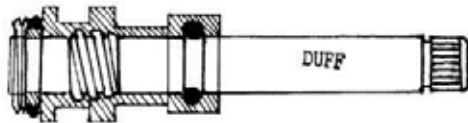

STERLING BATH STEM

FIG. NO.	PRICE
49343	

**ELKAY
MICRACORE
CARTRIDGE**



FIG. NO.	TYPE
131517	Cold
131518	Hot

**KOHLER
CERAMIC
CARTRIDGE**



FIG. NO.	TYPE
67060	Cold
105034	Hot

**STERLING LAV
HANDLE**



STERLING LAV HANDLES
Chrome plated canopy lever.
Screws Included.

FIG. NO.	PRICE
HOT 10383	
COLD 10385	

**STERLING BATH
HANDLE**



STERLING BATH HANDLES
Chrome plated canopy
cross. Screws Included.

FIG. NO.	PRICE
HOT 10394	
COLD 10395	

**STERLING TUB DIVERTER
HANDLE**

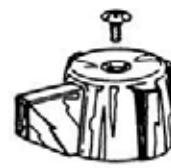

**STERLING TUB DIVERTER
HANDLES**
Chrome plated canopy
lever. Screw Included.

FIG. NO.	PRICE
10379	



STERLING SEAT

FIG. NO.	PRICE
10376	

**ORDER
NOW!**

Order Now!

610-275-4453

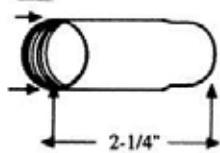

**Sterling
Sleeve**

FIG. NO.	PRICE
10364	



Sterling flat escutcheon.

FIG. NO.	PRICE
50377	



**Sterlin Lav
Stem**

FIG. NO.	PRICE
10425	

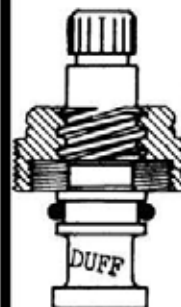

**Sterling
Laundry Stem**

FIG. NO.	PRICE
10419	



**Sterling Bath
& Shower
Valve Washer**

FIG. NO.	PRICE
10435	

REPLACEMENT STEMS AND HANDLES



Gerber Shower Valve Stem Unit

FIG. NO.	PRICE
17201	

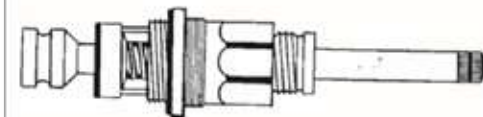

Gerber Diverter Stem

FIG. NO.	PRICE
17199	

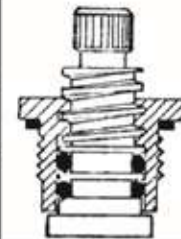

Gerber Lav and Kitchen Stem Unit

FIG. NO.	PRICE
HOT	17192
COLD	17193



Gerber Bath Handles

FIG. NO.	PRICE
41547	



Gerber Deep-Broach Tub Handles

FIG. NO.	PRICE
50551	



Gerber Old-Style Tub Cross-Handles

FIG. NO.	PRICE
41548	



Gerber Lav or Sink Handles

FIG. NO.	PRICE
41549	



Gerber Index Buttons

FIG. NO.	PRICE
HOT	48492
COLD	48493
DIVERTER	48494

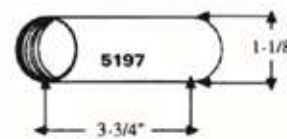

Gerber escutcheon tube.

FIG. NO.	PRICE
48533	



Gerber escutcheon

FIG. NO.	PRICE
45374	

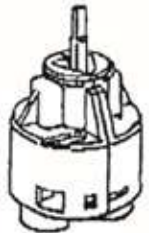

Elkay Cartridge. Drip free, washerless.

FIG. NO.	PRICE
51771	

DUFF DIFFERS

WE'LL SHOW YOU HOW ...

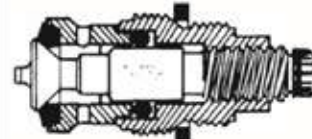

Crane Stem

FIG. NO.	PRICE
HOT	17049
COLD	17053



Gerber seat

FIG. NO.	PRICE
19756	

ANTI-SCALD DEVICES
PROTECTION AT THE FAUCET
PROTECT CHILDREN AND SENIORS!

- PP1996 Anti-Scald Aerator 55/64" I.D. Thread
- PP1997 Anti-Scald Aerator 15/16" O.D. Thread
- PP1994 Anti-Scald Shower Arm Insert
- PP1995 Anti-Scald Bathtub Spout



MAX TEMP 120° F

INTERCHANGEABLE STEMS FITS
BRADLEY,
ELKAY
AND UNIVERSAL RUNDLE



All Inter-changeable

FIG. NO.	PRICE
HOT	17449
COLD	17450

HANDLES

GRIPITTE LUCITE HANDLES



Plastic fit-all lav handles (pair)

FIG. NO.	PRICE
48855	



Plastic fit-all bath handles (pair)

FIG. NO.	PRICE
47938	



Plastic fit-all diverter handle.

FIG. NO.	PRICE
47939	



Plastic fit-all tub handle (pair)

FIG. NO.	PRICE
58605	



Pair - Griptite cross handle - chrome plated.

FIG. NO.	PRICE
15065	



Pair - Griptite lever handle - chrome plated.

FIG. NO.	PRICE
15062	



Griptite five point handle chrome plated (each)

FIG. NO.	PRICE
58602	

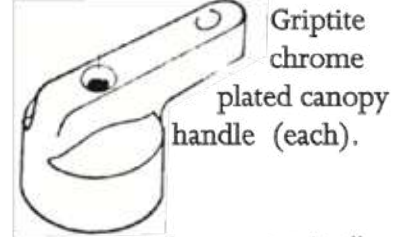

Griptite chrome plated canopy handle (each).

Lav base = 1 7/16"
Tub base - 1 5/8"

	FIG. NO.	PRICE
LAV	58603	
TUB	58604	

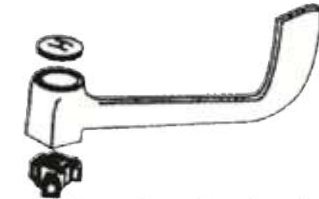
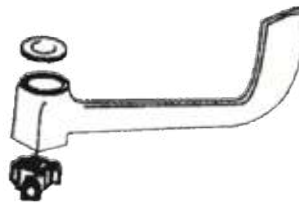

Griptite elbow handles (pair)

FIG. NO.	PRICE
58601	

KOHLER SHOWER PRESSURE BALANCING UNIT



FIG. NO.
180886

KOHLER MIXER CAP FOR PRESSURE BALANCE VALVE



FIG. NO.
183829

KOHLER MIXER CAP FOR PRESSURE BALANCE VALVE



FIG. NO.
721440

AERATORS



DUAL AERATOR	
FIG. NO.	PRICE
15145	



15/16 MALE AERATOR	
FIG. NO.	PRICE
43461	





15/16 FEMALE AERATOR	
FIG. NO.	PRICE
43462	







13/16 FEMALE AERATOR	
FIG. NO.	PRICE
15147	

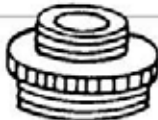





13/16 MALE AERATOR	
FIG. NO.	PRICE
15146	

<p>LOW FLOW</p>  <p>1.5 LOW FLOW DUAL THREAD</p> <table border="1"> <tr> <th>FIG. NO.</th> <th>PRICE</th> </tr> <tr> <td>48651</td> <td></td> </tr> </table>	FIG. NO.	PRICE	48651		<p>AERATOR</p>  <p>15/16 VANDAL PROOF AERATOR</p> <table border="1"> <tr> <th>FIG. NO.</th> <th>PRICE</th> </tr> <tr> <td>40816</td> <td></td> </tr> </table>	FIG. NO.	PRICE	40816		<p>AERATOR BUSHING</p>  <p>15/16 X 13/16 BUSHING</p> <table border="1"> <tr> <th>FIG. NO.</th> <th>PRICE</th> </tr> <tr> <td>65514</td> <td></td> </tr> </table>	FIG. NO.	PRICE	65514		<p>MALE AERATOR ADAPTER</p>  <p>STANDARD MALE AERATOR</p> <table border="1"> <tr> <th>SIZE</th> <th>FIG. NO.</th> <th>PRICE</th> </tr> <tr> <td>3/8</td> <td>50610</td> <td></td> </tr> <tr> <td>13/16</td> <td>50601</td> <td></td> </tr> </table>	SIZE	FIG. NO.	PRICE	3/8	50610		13/16	50601	
FIG. NO.	PRICE																							
48651																								
FIG. NO.	PRICE																							
40816																								
FIG. NO.	PRICE																							
65514																								
SIZE	FIG. NO.	PRICE																						
3/8	50610																							
13/16	50601																							

SNAP AERATORS

 <p>LARGE SNAP AERATOR</p> <table border="1"> <tr> <th>FIG. NO.</th> <th>PRICE</th> </tr> <tr> <td>47228</td> <td></td> </tr> </table>	FIG. NO.	PRICE	47228		 <p>HOSE SNAP COUPLER LARGE</p> <table border="1"> <tr> <th>FIG. NO.</th> <th>PRICE</th> </tr> <tr> <td>15150</td> <td></td> </tr> </table>	FIG. NO.	PRICE	15150		 <p>SMALL SNAP AERATOR</p> <table border="1"> <tr> <th>FIG. NO.</th> <th>PRICE</th> </tr> <tr> <td>15144</td> <td></td> </tr> </table>	FIG. NO.	PRICE	15144		 <p>HOSE SNAP COUPLER SMALL</p> <table border="1"> <tr> <th>FIG. NO.</th> <th>PRICE</th> </tr> <tr> <td>15151</td> <td></td> </tr> </table>	FIG. NO.	PRICE	15151	
FIG. NO.	PRICE																		
47228																			
FIG. NO.	PRICE																		
15150																			
FIG. NO.	PRICE																		
15144																			
FIG. NO.	PRICE																		
15151																			

 <p>SWIVEL MXF AERATOR</p> <table border="1"> <tr> <th>FIG. NO.</th> <th>PRICE</th> </tr> <tr> <td>15148</td> <td></td> </tr> </table>	FIG. NO.	PRICE	15148		 <p>15/16" Male - 55/64" Female x Hose Adapter</p> <table border="1"> <tr> <th>FIG. NO.</th> <th>PRICE</th> </tr> <tr> <td>15152</td> <td></td> </tr> </table>	FIG. NO.	PRICE	15152		 <p>LAMINAR FLOW DUAL AERATOR</p> <table border="1"> <tr> <th>FIG. NO.</th> <th>PRICE</th> </tr> <tr> <td>50547</td> <td></td> </tr> </table>	FIG. NO.	PRICE	50547		 <p>HOSE TO AERATOR ADAPTER</p> <table border="1"> <tr> <th>FIG. NO.</th> <th>PRICE</th> </tr> <tr> <td>140761</td> <td></td> </tr> </table>	FIG. NO.	PRICE	140761	
FIG. NO.	PRICE																		
15148																			
FIG. NO.	PRICE																		
15152																			
FIG. NO.	PRICE																		
50547																			
FIG. NO.	PRICE																		
140761																			

ASSORTED NEOPRENE WASHERS



Packed 100 to a Plastic Container.

FLAT

SIZE	FIG. NO.	PRICE
#0	24683	
#00	14941	
1/4S	14943	
1/4	14945	
1/4L	14951	
3/8	14953	
3/8M	14954	
3/8L	101466	
1/2	101467	
1/2L	14957	
5/8	80575	

BEVELED

SIZE	FIG. NO.	PRICE
#0	24686	
#00	14918	
1/4	14922	
1/4L	14924	
3/8	14927	
3/8M	14928	
3/8L	14930	
1/2	14931	
1/2L	14935	
5/8	14938	

BRASS BOXED BIBB SCREWS (100 PER PACK)



SIZE	FIG. NO.	PRICE
ASSORTED	14909	
1/2X10-24	14908	
1/2X8-32	14906	
3/8X10-24	14907	
3/8X8-32	66823	

WASHERS

JUNIOR NEOPRENE WASHER KIT



Includes 100 washers and 18 Brass Screws.

FLAT		BEVELED	
FIG. NO.	PRICE	FIG. NO.	PRICE
14962		14916	

TAPERED NYLON SLIP JOINT WASHER

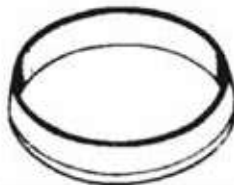

SIZE	FIG. NO.	PRICE
1 1/4	14736	
1 1/2	14738	
1 1/2 X 1	14742	

AMERICAN STANDARD GRAPHITE URINAL GASKET



FIG. NO.	PRICE
14654	

SINK CONNECTION WASHER



FIG. NO.	PRICE
14687	

TUB OVERFLOW WASHERS



FIG. NO.	PRICE
19000	

SENIOR NEOPRENE WASHER KIT



Includes 200 washers and 50 Brass Screws.

FLAT		BEVELED	
FIG. NO.	PRICE	FIG. NO.	PRICE
38923		38922	

NYLON TAILPIECE WASHER

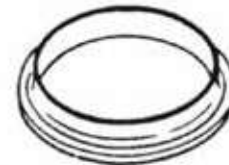

SIZE	FIG. NO.	PRICE
1 1/2	14685	

KOHLER URINAL GASKET



FIG. NO.	PRICE
4938	

RUBBER SLIP JOINT WASHERS



SIZE	FIG. NO.	PRICE
1 1/4"	14723	
1 1/2"	14726	
2"	14729	
1 1/2 X 1 1/4	14731	

BIBB SCREW TAP 10-24

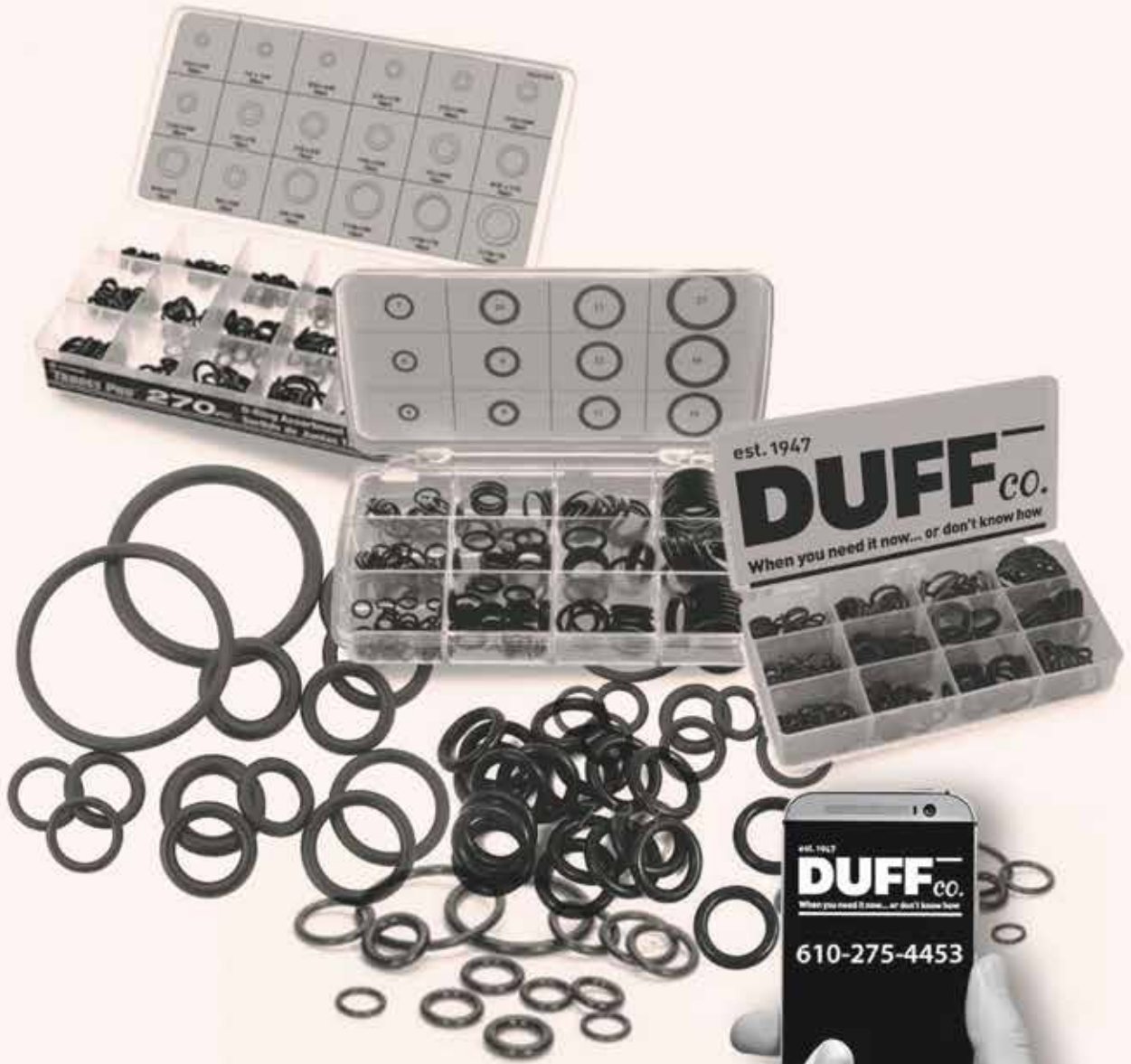

FIG. NO.	PRICE
43273	

O-RING KITS

CALL DUFF FOR ANY O-RING OR O-RING KIT YOU MAY NEED.

DUFF HAS THEM!



DUFF DELIVERS



For additional information call: 610-275-4453 or Fax: 610-279-6299
Please call for current prices.

FAUCET O-RING KITS

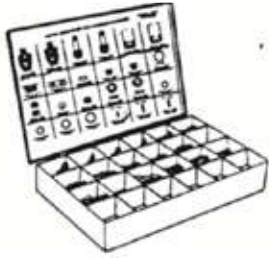

American Standard

FIG. NO.	PRICE
15080	

CALL DUFF FOR PRICES AND AVAILABILITY



Gerber

CALL DUFF FOR PRICES AND AVAILABILITY



Central Brass

CALL DUFF FOR PRICES AND AVAILABILITY

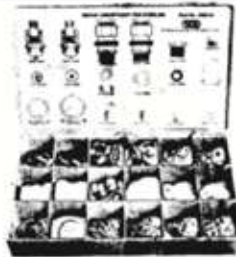

Sterling

CALL DUFF FOR PRICES AND AVAILABILITY



Moen

FIG. NO.	PRICE
15096	



Delta

FIG. NO.	PRICE
19905	



Chicago

CALL DUFF FOR PRICES AND AVAILABILITY



T & S

CALL DUFF FOR PRICES AND AVAILABILITY



Valley

FIG. NO.	PRICE
54282	



Sayco

CALL DUFF FOR PRICES AND AVAILABILITY



Crane

FIG. NO.	PRICE
15094	

O-RING KITS & ASSORTMENTS



Plumbers "O" Ring Kit. 200 assorted rings, 12 of the most popular sizes.

FIG. NO.	PRICE
14899	



Faucet Seat Kit. 64 of the 12 most popular seat sizes!

FIG. NO.	PRICE
15097	

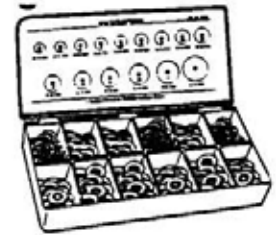

Replacement Kit of faucet washers. 100 washers with 18 brass screws.

DESCR	FIG. NO.	PRICE
FLAT	14962	
BEV	14916	



Industrial "O" Ring kit. The most complete assortment available. 420 pieces of 24 different sizes.



80 piece assortment "No Rotate" washers.

FIG. NO.	PRICE
65081	



Replacement kits for faucet washers. 200 washers with 50 brass screws.

DESCR	FIG. NO.	PRICE
FLAT	38923	
BEV	38922	



Kit for brass faucet screws. 300 pieces of 12 different sizes.

FIG. NO.	PRICE
65085	

CALL DUFF FOR PRICES AND AVAILABILITY



Replacement kit for kitchen spout repairs.

FIG. NO.	PRICE
65080	



Replacement kits for fibre faucet washers. 240 pieces of 10 different sizes.

CALL DUFF FOR PRICES AND AVAILABILITY

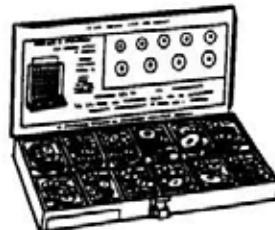

Replacement kits for teflon faucet washers. 96 pieces of sizes 000 to 1/2"

FIG. NO.	PRICE
65088	



Replacement kit for faucet washers, washer retainers & screws. Contains 316 pieces of 48 different types!

FIG. NO.	PRICE
65097	

O-RING KITS



Replacement kit for aerator washers. 150 pieces of 7 different sizes.

FIG. NO.	PRICE
65101	



Replacement kit for aerator repairs. 105 pieces of 18 different styles.

CALL DUFF FOR PRICES AND AVAILABILITY



Replacement kits for index buttons. 100 pieces of 25 different types.

FIG. NO.	PRICE
65103	



Replacement kits for chrome faucet handle screws. Contains 300 pieces of 12 different sizes.

CALL DUFF FOR PRICES AND AVAILABILITY

DUFF DIFFERS

ASK US HOW ...



Replacement kit for lavatory pop-up repairs. 40 pieces.

FIG. NO.	PRICE
65100	



Replacement kit for automatic spray diverters. 18 different types.

CALL OR EMAIL DUFF FOR PRICES AND AVAILABILITY



Replacement kit for waste & overflow. 47 pieces of 24 different types.

CALL OR EMAIL DUFF FOR PRICES AND AVAILABILITY



Ballcock repair kit. 180 pieces of 18 different types.

CALL OR EMAIL DUFF FOR PRICES AND AVAILABILITY



Replacement kit for frostproof sillcocks. 99 pieces of 24 different types.

FIG. NO.	PRICE
65096	



Replacement kit for electric and gas range oven knobs. Electric has 86 pieces of 11 different types. Gas contains 74 pieces of 8 different types.

CALL OR EMAIL DUFF FOR PRICES AND AVAILABILITY



Replacement kit for window cranks & extensions. 50 pieces of 13 different styles.

CALL OR EMAIL DUFF FOR PRICES AND AVAILABILITY

CALL OR EMAIL DUFF TODAY, WE HAVE YOUR O-RING SOLUTIONS.
610-275-4453
INFO@DUFFCO.COM



O-RING KITS CONTINUED

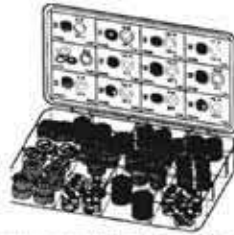

Bonnet packing kit. 98 piece assorted faucet stem bonnet packings.

FIG. NO.	PRICE
73451	

CALL DUFF FOR PRICES AND AVAILABILITY



Replacement kit for cone washers. 78 total pieces of 11 different sizes.

CALL DUFF FOR PRICES AND AVAILABILITY

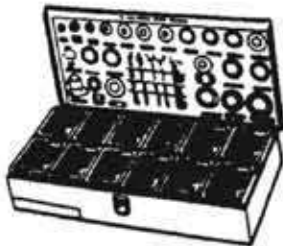

Bath diverter kit, 130 pieces, 22 different sizes.

CALL DUFF FOR PRICES AND AVAILABILITY



Replacement kit for solderless terminals. Contains 223 total pieces.

FIG. NO.	PRICE
73454	



Commercial O-ring Kit

FIG. NO.	PRICE
66799	

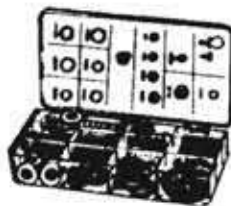

Faucet Stem Nut Fibre Washers. 200 in Kit.

FIG. NO.	PRICE
56832	

WE'RE FLEXIBLE!
CUSTOM KITS ARE OUR SPECIALTY!
Call or email your DUFF rep today!

610-275-4453 • info@duffco.com





GARBAGE DISPOSALS



Badger 1

- 1/3 HP
- 1-year in-home service warranty
- Galvanized steel



FIG. NO.
7876

Badger 5

- 1/2 HP
- 2-year in-home service warranty
- Galvanized steel



FIG. NO.
7874

Contractor 333

- 3/4 HP
- 3-year in-home service warranty
- Stainless steel



FIG. NO.
218756

Evolution Pro 750

- 3/4 HP
- 6-year in-home service warranty
- Stainless steel
- Auto-Reverse Grind System®



FIG. NO.
188326

Evolution Pro 800

- 7/8 HP
- 8-year in-home service warranty
- Stainless steel



FIG. NO.
188323

Evolution Pro 1100XL

- 1.1 HP
- 12-year in-home service warranty
- Stainless steel



FIG. NO.
188321

Evolution Septic Assist

- 3/4 HP
- 4-year in-home service warranty
- Stainless steel
- Ideal for homes with septic systems



FIG. NO. DESCRIPTION
85841 Disposal with Bio-Charge
87750 Replacement Bio-Charge

DUFF Disposal

- 1/2 HP
- The economical choice for multi-family housing



FIG. NO.
244823

Pro Cover Control Plus

- 7/8 HP
- 9-year in-home service warranty
- Stainless steel
- Twist-lock operation (no wall switch needed)



FIG. NO.
188327

Invite Series Instant Hot Water Dispenser

- **Hot only** – Dispenses near-boiling 200°F water
- Includes 2/3-gallon hot water tank
- Easy to adjust temperature control
- 3-year in-home service warranty



FIG. NO.
182378

Sink-Top Air Switch

- Convenient alternative to wall switch
- Air activated
- Mounts easily to sink or countertop
- For use with all InSinkErator disposals



FIG. NO.
171670

TYPICAL INSTALLATION

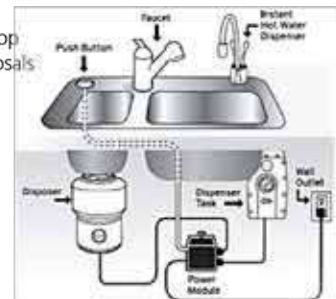

Instant Hot Water Tank and Filter

- **Hot only** – Dispenses near-boiling 200°F water
- Includes 2/3-gallon hot water tank
- Easy to adjust temp. control
- 3-year in-home service warranty (filtration system 1-year)
- Faucet not included



FIG. NO.
204904

Instant Hot Water Faucet

- Faucet only
- Chrome (other finishes available)



FIG. NO.
205104

Vinyl Sink and Garbage Disposal Stopper



FIG. NO.
14844

Rubber Garbage Disposal Splash Guard



FIG. NO. TYPE
14843 Fit-All
194472 ISE Brand (shown)

COMMERCIAL DISPOSALS

Typical Installation

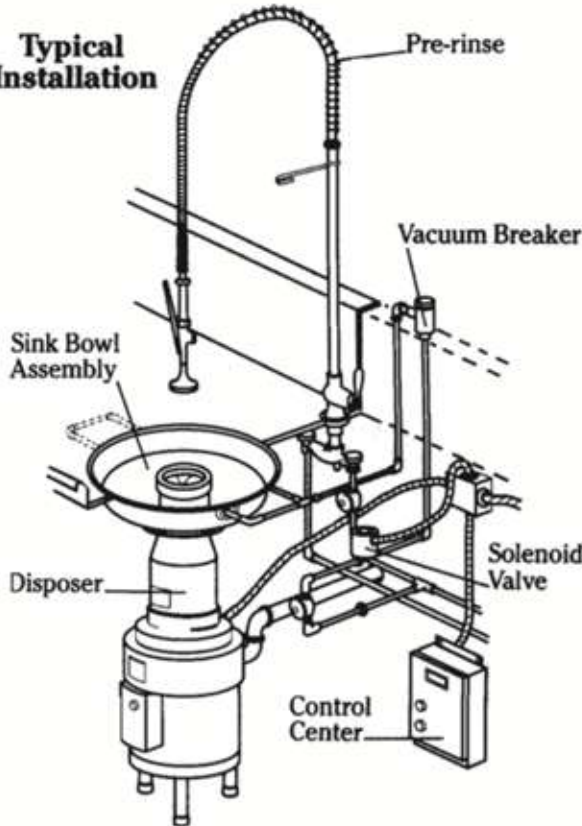

DUFF COMPANY OFFERS A COMPLETE LINE OF INSINKERATOR COMMERCIAL DISPOSERS 1/2 HP THRU 10 HP.

WE CAN ADAPT TO MANY BRANDS, INCLUDING WASTE KING, NATIONAL, RED GOAT, FMC, AVANT, BUS BOY, AMERICAN DELPHI, ATOMIC, SALVAJOR, HOBART, GE, AND MASTER!

FEATURES:

- *Corrosion resistant stainless steel.
- *3/4" rubber mounting above grind chamber isolates sound and eliminates vibration.
- *Induction motor totally enclosed to provide protection against outside moisture. Controlled power air flow cools motor for efficiency and longer life.
- *Stationary and rotating shredding elements made from cast nickel chrome alloy for long life and corrosion resistance, designed for reverse action grinding.
- *All stainless steel and chrome plated. Paint-free for lasting sanitation.



"WHETHER YOU SERVE 25 OR 2500 PEOPLE, THERE'S AN INSINKERATOR DISPOSER THAT'S RIGHT FOR YOU!"



Recommended Sizing Chart*					
Persons Per Meal	Soiled Dish Table	Vegetable Prep. Area	Salad Prep. Area	Pot Sink	Meat Prep. Area
Up to 100	SS-75	SS-50	—	—	—
100—150	SS-100	SS-75	SS-50	SS-50	—
150—175	SS-125	SS-100	SS-75	SS-50	SS-150
175—200	SS-150	SS-150	SS-75	SS-75	SS-150
200—300	SS-200	SS-150	SS-75	SS-75	SS-300
300—750	SS-300	SS-150	SS-75	SS-75	SS-300
750—1500	SS-500	SS-300	SS-150	SS-150	SS-500
1500—2500	(2) SS-500	SS-300	SS-150	SS-150	SS-500

2500-over, contact your DUFF REPRESENTATIVE.

For special applications such as supermarkets or other heavy continuous volume installations, select model SS-750 or SS-1000.

*The models listed are the minimum size INSINKERATOR to be used at the point-of-origin for food wastes. Sizing recommendations re given in general terms. Actual capacities vary depending on the type of food waste.

How to Order

Submit your order online
or
email info@duffco.com

Be sure to include
product numbers
descriptions
quantities

Don't forget to include your name!

DUFF SUPPLY COMPANY

WATER TREATMENT EQUIPMENT - PUMPS - PLUMBING - HEATING - INDUSTRIAL SUPPLIES - PUMPS
 STEAM SPECIALTIES - PIPE - VALVES - FITTINGS - SOFTENERS - FILTERS
 201 EAST LAFAYETTE STREET, P.O. BOX 618, NORRISTOWN, PA 19401
 PHONE: 610-275-4453 FAX: 610-279-6299



SOLD TO:

SHIP TO:

YOUR NAME: _____ PURCHASE ORDER NO. _____

TODAY'S DATE: _____ REQUIRED DATE: _____

QTY	FIG. NO.	DESCRIPTION	PRICE/EA	TOTAL



TERMS: NET - 10TH OF MONTH FOLLOWING PURCHASE
 WE WILL PREPAY AND ADD FREIGHT FOR ALL ORDERS SHIPPED UPS OR COMMON CARRIER

All accounts are to be paid in full to Duff Supply Company monthly by the tenth (10th) day of the month following invoice date, a 1% service charge and a 1% interest charge will be made on any balance open at the end of the month following invoice, and in the event that legal action or lien be undertaken, or the service of a collection agency are used to collect this account, the customer shall pay all expenses incurred by Duff Supply Company, such as, but not limited to, costs and collection, legal and lien fees.

Contact name _____ Contact Date _____

	<h2 style="margin: 0;">DUFF COMPANY</h2> <p style="margin: 0;">201 East Lafayette Street Norrstown, PA 19401</p> <p style="margin: 0;">Phone: 610-275-4453 Fax: 610-279-6761</p>	
---	--	---

Legal Name _____

Name in which business is conducted _____

Billing Address _____

City _____ State _____ Zip _____

Purchasing Phone _____ A/P Phone _____ Fax _____



Principal's Name _____

Principal's Address _____

City _____ State _____ Zip _____

Phone (Office) _____ (Cell) _____ E-mail address _____

Website address (If applicable) _____

Primary Contact _____ Title _____



SHIPPING ADDRESS - IF DIFFERENT

Shipping Address _____ Phone _____

City _____ State _____ Zip _____

Tax Exempt Number _____ Provide a copy of Certificate. We CAN NOT set up a Tax Exempt Account without certification.



TYPE OF BUSINESS

Plumbing _____ Pumps _____ Heating _____ Municipality _____ Hotel or Apts. _____ Well Drilling _____
 Hospital _____ Factory (OEM) _____ Factory (Mtn) _____ Office Building _____ Shopping Center _____
 Golf Course _____ Water Treatment _____ Environmental _____ Other (Please name) _____

Have you been contacted by one of our salesman? _____ Name _____

If YES, please explain _____

Name of person authorized to pick up _____

D&B Rating _____ Check one: Corporation _____ Partnership _____ Individual Proprietor _____

If division of another company, name parent company and relationship _____

DUFF COMPANY

201 East Lafayette Street, Norristown, PA 19401

TRADE REFERENCES

Name _____ Type of business _____

Address _____

City _____ State _____ Zip _____

Phone _____ Fax _____



Name _____ Type of business _____

Address _____

City _____ State _____ Zip _____

Phone _____ Fax _____



Name _____ Type of business _____

Address _____

City _____ State _____ Zip _____

Phone _____ Fax _____



Bank reference _____

Branch Address _____

City _____ State _____ Zip _____

Branch officer who handles account _____

In consideration of your opening the above account and/or extended credit, the undersigned hereby agrees that all information supplied in this application is correct, that all accounts are to be paid in full to Duff Company monthly by the tenth day of the month following the invoice date, that a 1% service charge and a 1% interest charge will be made on any balance open at the end of the month following invoice date, and that in the event that legal action or lien be taken, or the service of a collection agency are used to collect this account, the undersigned shall pay all expenses incurred by the Duff company, such as, but not limited to, collection fees, costs and legal fees.

Applicant (Name of Account) _____

By _____ Title _____

The undersigned _____ and _____
for good and valuable consideration, hereby jointly, severally and personally unconditionally guarantee, warrant and promise the full and prompt (within terms) payments of all bills and other obligations (as set forth above) of the applicate in connection with any credit extended to the applicant by Duff Company.*

Principal _____ Witness _____ Principal's Spouse _____ Witness _____

Principal _____ Witness _____ Principal's Spouse _____ Witness _____

We routinely fax invoices to our customers. Please provide a fax number where we can send invoices _____

PLEASE FAX FORM TO 610-275-6761

*As appropriate, we may also require the guarantee of a principal and, in some cases, the principal's spouse.

For Duff Company Use Only		
Credit Limit: _____	Contact: _____	Certificate Recd: _____
Tax Jurisdiction: _____	General Manager: _____	Type: _____
Salesman: _____	Class: _____	Controller: _____
	Date Approved: _____	