

Fire Protection

est. 1947

DUFF[—]co.

When you need it now... or don't know how

PLUMBING & HEATING • PUMPS • WATER CONDITIONING
MULTIFAMILY HOUSING SUPPLIES



CATALOG

610.275.4453

duffcompany.com

POTTER-ROEMER, INC.



A Subsidiary of Jay R Smith Mfg Co.

EXPOSED FIRE DEPT. INLET CONNECTIONS — CLAPPER TYPE

5710 TWO-WAY WITH SINGLE CLAPPER

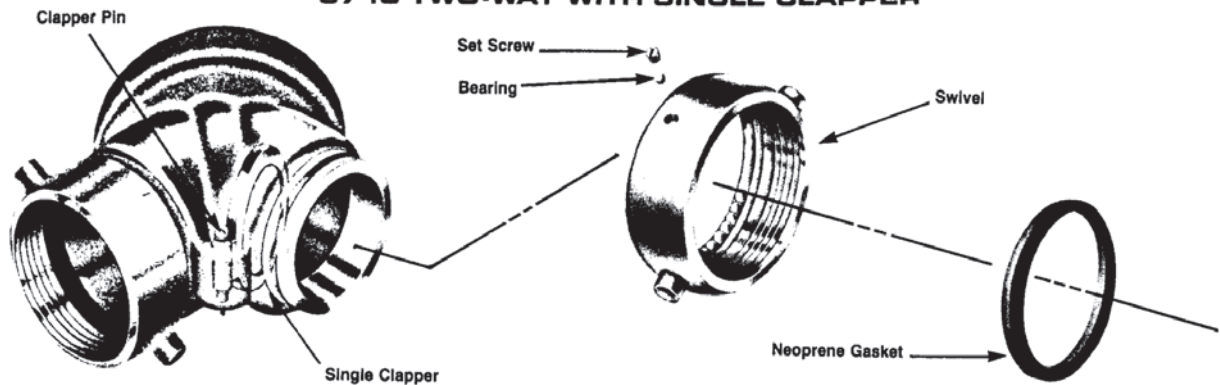

TWO-WAY WITH SINGLE CLAPPER

FUNCTION: Used as an auxiliary inlet connection providing 500 G.P.M. minimum (Ref. NFPA No. 14) to supplement the fire protection water supply. Swing clapper provides unobstructed waterway. Exposed design is an economical method of satisfying fire dept. inlet requirements.

REGULARLY FURNISHED: Cast brass two-way inlet body, swing clapper and pin lug swivel. Back or angle outlet as selected by figure number. Lettering as selected. Size 4" x 2 1/2" x 2 1/2".

- OPTIONAL FINISHES:**
- B Polished Brass
 - C Rough Chrome Plated
 - D Polished Chrome Plated

LETTERING AVAILABLE:
 AUTO. SPKR.
 STANDPIPE

SPECIFY thread and lettering

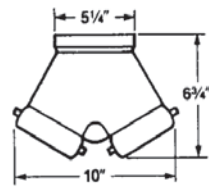

FIG. NO. 88221 BACK OUTLET
4 X 2 1/2

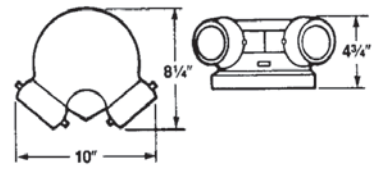
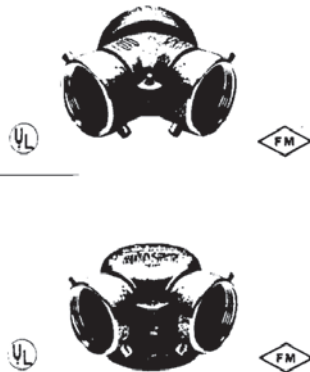

FIG. NO. 88222 ANGLE OUTLET
4 X 2X2 1/2



TWO-WAY WITH DOUBLE CLAPPERS

FUNCTION: Used as an auxiliary inlet connection providing 500 G.P.M. minimum (Ref. NFPA No. 14) to supplement the fire protection water supply. Drop clappers provide unobstructed waterway. Exposed design is an economical method of satisfying fire dept. inlet requirements.

REGULARLY FURNISHED: Cast brass two-way inlet body, drop clappers and pin lug swivels. Size and outlet as selected by figure number. Lettering as selected.

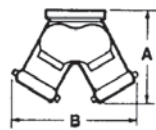

FIG. NO. 87876-87879
Back Outlet

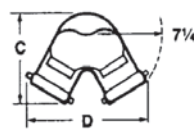

FIG. NO. 87881-87884
90° Angle Outlet

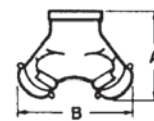

FIG. NO. 87880
45° Angle Outlet



| Size | A | B | C | D |
|-----------------------|-------|--------|--------|--------|
| 4 1/2 x 2 1/2 x 2 1/2 | 7 1/2 | 11 1/2 | 8 1/2 | 11 1/4 |
| 6 x 2 1/2 x 2 1/2 | 9 1/2 | 10 1/2 | 9 | 10 3/4 |
| 4 x 3 x 3 | 9 1/2 | 11 1/2 | 9 1/2 | 11 |
| 6 x 3 x 3 | 10 | 11 | 10 1/2 | 11 |
| 4 x 2 1/2 x 2 1/2 | 8 | 11 | — | — |

ALL DIMENSIONS IN INCHES

- OPTIONAL FINISHES:**
- B Polished Brass
 - C Rough Chrome Plated
 - D Polished Chrome Plated

LETTERING AVAILABLE:
 AUTO. SPKR.
 STANDPIPE

SPECIFY thread and lettering

**NON-ADJUSTABLE REG-U-MATIC
PRESSURE REGULATING VALVES**

**TYPICAL NON-ADJUSTABLE PRESSURE
REGULATING VALVE (4050 SHOWN)**

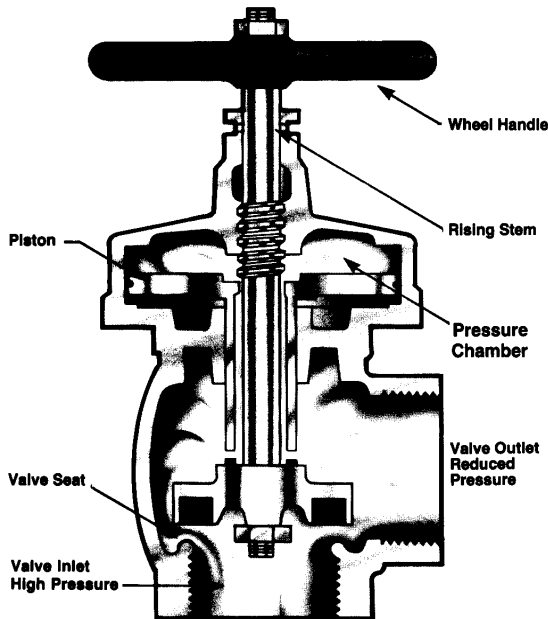

FEATURES AND DATA

- Selected pressure control under residual and static conditions.
- Selected pressure control for 20 to 400 P.S.I.
- Listed by Underwriters Laboratories at 400 P.S.I. pressure.
- Listed by Underwriters Laboratories as a checking device.
- Hydraulic piston design.
- Under low residual supply pressure valve fully opens.
- Complete piping system can be hydrostatically tested to 400 P.S.I. without damage to valve.
- Maximum back pressure does not damage valve components.
- Tamper Proof Pressures.
- Monitor Switch Adapter to provide valve supervision.
- Designed for high pressure sprinkler, standpipe and combined fire protection systems.

ORDERING INFORMATION

- Select type and size by figure number.
- Select required pressure range. (See Appendix page VII)
- Select hose thread for male outlets.
- Optional Finish: -C Rough Chrome Plated.
- For factory selection of proper application advise
 1. Valve inlet P.S.I. Residual.
 2. G.P.M. Flow requirement.
 3. Valve outlet P.S.I. requirement.

**VALVE SELECTION CHARTS AVAILABLE SEE APPENDIX PAGE IX
1 1/2" VALVE LISTED AT 300 P.S.I. PRESSURE**

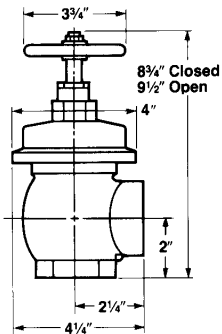

1 1/2" FEMALE x FEMALE

FUNCTION: Used as a hose station control to regulate inlet pressure to 300 P.S.I. Also may be used as a zone control valve to regulate high pressure sprinkler, standpipe and combined systems with flow up to 250 G.P.M.

REGULARLY FURNISHED: Cast brass valve with rising stem, internal parts of brass and stainless steel, aluminum handwheel. Female NPT inlet and outlet.

OPTION: - MSA Monitor Switch Adapter with Visual Indicator.

| FIG NO | PRICE |
|--------|-------|
| 83684 | |

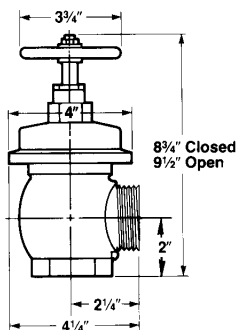

1 1/2" FEMALE x MALE

FUNCTION: Used as a hose station to regulate inlet pressure to 300 P.S.I.

REGULARLY FURNISHED: Cast brass valve with rising stem, internal parts of brass and stainless steel, aluminum handwheel. Female NPT inlet x male hose thread outlet.

OPTION: - MSA Monitor Switch Adapter with Visual Indicator.

| FIG NO | PRICE |
|--------|-------|
| 83685 | |

NOTE: ALWAYS INDICATE HOSE THREAD REQUIREMENTS.

POTTER-ROEMER, INC.



A Subsidiary of Jay R. Smith Mfg. Co.

EXPOSED FIRE DEPT. INLET CONNECTIONS — CLAPPER TYPE

5710 TWO-WAY WITH SINGLE CLAPPER

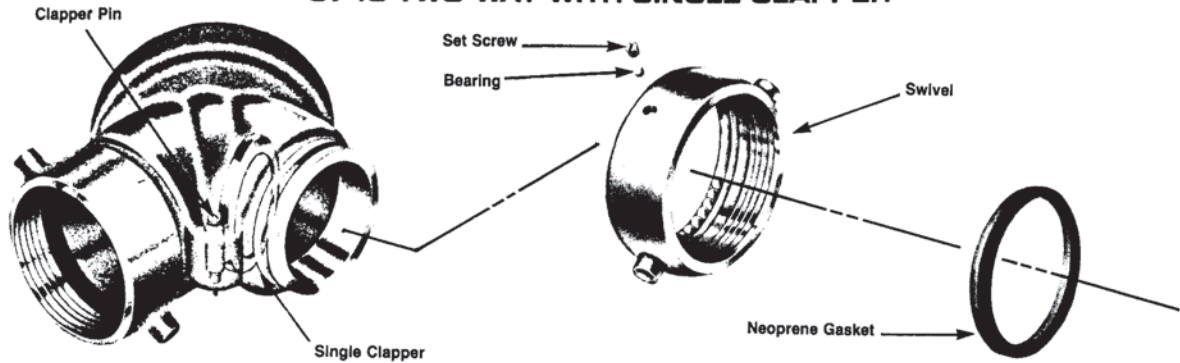

TWO-WAY WITH SINGLE CLAPPER

FUNCTION: Used as an auxiliary inlet connection providing 500 G.P.M. minimum (Ref. NFPA No. 14) to supplement the fire protection water supply. Swing clapper provides unobstructed waterway. Exposed design is an economical method of satisfying fire dept. inlet requirements.

REGULARLY FURNISHED: Cast brass two-way inlet body, swing clapper and pin lug swivel. Back or angle outlet as selected by figure number. Lettering as selected. Size 4" x 2 1/2" x 2 1/2".

OPTIONAL FINISHES:

- B Polished Brass
- C Rough Chrome Plated
- D Polished Chrome Plated

LETTERING AVAILABLE:

AUTO. SPKR.
STANDPIPE

SPECIFY thread and lettering

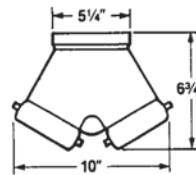

FIG. NO. 88221 BACK OUTLET
4 X 2 1/2

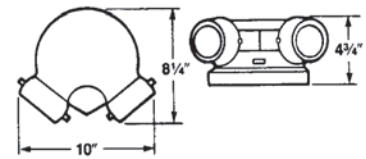

FIG. NO. 88222 ANGLE OUTLET
4 X 2X2 1/2

TWO-WAY WITH DOUBLE CLAPPERS

FUNCTION: Used as an auxiliary inlet connection providing 500 G.P.M. minimum (Ref. NFPA No. 14) to supplement the fire protection water supply. Drop clappers provide unobstructed waterway. Exposed design is an economical method of satisfying fire dept. inlet requirements.

REGULARLY FURNISHED: Cast brass two-way inlet body, drop clappers and pin lug swivels. Size and outlet as selected by figure number. Lettering as selected.

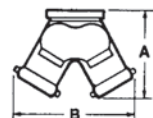

FIG. NO. 87876-87879
Back Outlet

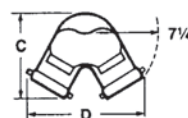

FIG. NO. 87881-87884
90° Angle Outlet

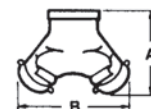

FIG. NO. 87880
45° Angle Outlet

| Size | A | B | C | D |
|-----------------------|-------|--------|--------|--------|
| 4 1/2 x 2 1/2 x 2 1/2 | 7 1/2 | 11 1/2 | 8 1/2 | 11 1/4 |
| 6 x 2 1/2 x 2 1/2 | 9 1/2 | 10 1/2 | 9 | 10 3/4 |
| 4 x 3 x 3 | 9 1/2 | 11 1/2 | 9 1/2 | 11 |
| 6 x 3 x 3 | 10 | 11 | 10 1/2 | 11 |
| 4 x 2 1/2 x 2 1/2 | 8 | 11 | — | — |

ALL DIMENSIONS IN INCHES

OPTIONAL FINISHES:

- B Polished Brass
- C Rough Chrome Plated
- D Polished Chrome Plated

LETTERING AVAILABLE:

AUTO. SPKR.
STANDPIPE

SPECIFY thread and lettering

HOSE VALVES

ANGLE

FEMALE X MALE

FUNCTION: Used with a fire hose rack assembly or as a fire dept. outlet connection.

REGULARLY FURNISHED: Cast brass valve with red hand wheel. Female N.P.T. inlet X male hose thread outlet. 300 lb.

| SIZE | FIG NO | PRICE |
|-------|--------|-------|
| 1 1/2 | — | |
| 2 1/2 | 59115 | |

SPECIFY thread

OPTIONAL FINISHES:

- B Polished Brass
- C Rough Chrome Plated
- D Polished Chrome Plated

VARIATIONS:

Extended stem up to 24", **SPECIFY** length
 1/8" petcock **SPECIFY** location

| Size | Closed | | Open | | D | E |
|-------|--------|-------|-------|--------|-------|-------|
| | A | B | C | C | | |
| 1 1/2 | 2 1/4 | 3 1/2 | 6 1/2 | 7 1/2 | 2 1/2 | 2 |
| 2 1/2 | 3 1/2 | 5 | 9 1/2 | 11 1/2 | 3 1/2 | 2 3/4 |

ALL DIMENSIONS IN INCHES

DOUBLE FEMALE

FUNCTION: Used with a fire hose rack assembly.

REGULARLY FURNISHED: Cast brass valve with red hand wheel. Female N.P.T. inlet and outlet. 300 lb. rated

| SIZE | FIG NO | PRICE |
|-------|--------|-------|
| 1 1/2 | 83690 | |
| 2 1/2 | 83692 | |

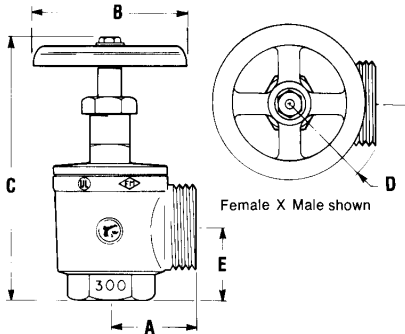

Female X Male shown

ADJUSTABLE PRESSURE RESTRICTING ANGLE VALVE

FEMALE X MALE

FUNCTION: Used with a fire hose rack assembly or as a fire dept. outlet connection. Water pressure is controlled by adjustable flow restriction. If full flow is required the restriction may be overridden.

REGULARLY FURNISHED: Cast brass valve with red hand wheel with pressure restricting feature. Female N.P.T. inlet X male hose thread outlet. 300 lb. rated. Furnished with field setting chart.

| SIZE | FIG NO | PRICE |
|-------|--------|-------|
| 1 1/2 | 83693 | |
| 2 1/2 | 83694 | |

DOUBLE FEMALE

FUNCTION: Used with a fire hose rack assembly. Water pressure is controlled by adjustable flow restriction. If full flow is required the restriction may be overridden.

REGULARLY FURNISHED: Cast brass valve with red hand wheel with pressure restricting feature. Female N.P.T. inlet and outlet. 300 lb. rated. Furnished with field setting chart.

| SIZE | FIG NO | PRICE |
|-------|--------|-------|
| 1 1/2 | 83695 | |
| 2 1/2 | 83696 | |

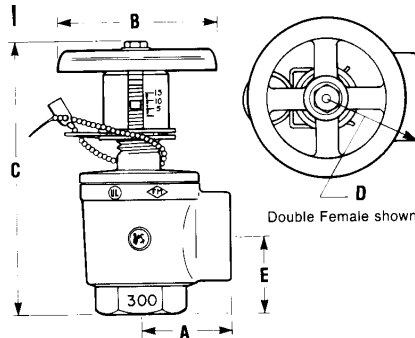

Double Female shown

DUFF DELIVERS



HOSE VALVES

STRAIGHT GLOBE

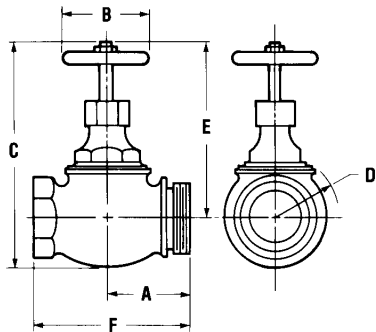

FEMALE X MALE

FUNCTION: Used with a fire hose assembly or as a fire dept. outlet connection.

REGULARLY FURNISHED: Cast brass valve with red hand wheel. Female N.P.T. inlet X male hose thread outlet. 300 P.S.I.

VARIATION: Extended stem up to 24", SPECIFY length

| Size | Closed | | Open | | D | E | F |
|-------|--------|-------|--------|--------|-------|-------|-------|
| | A | B | C | C | | | |
| 1/2 | 1/8 | 2 | 4 | 4 1/4 | 1 | 3 3/8 | 2 1/4 |
| 1 1/2 | 2 1/2 | 3 1/2 | 7 1/4 | 8 1/4 | 3 | 5 3/4 | 4 3/4 |
| 2 1/2 | 3 1/2 | 5 | 10 1/4 | 11 1/4 | 3 1/2 | 8 1/4 | 7 |

ALL DIMENSIONS IN INCHES

DOUBLE FEMALE

FUNCTION: Used with a fire hose rack assembly or as a drain valve.

REGULARLY FURNISHED: Cast brass valve with red hand wheel. Female N.P.T. inlet and outlet. 300 P.S.I.

| SIZE | FIG NO | PRICE |
|-------|--------|-------|
| 1/2 | 83700 | |
| 1 1/2 | 83701 | |
| 2 1/2 | 83702 | |

OPTIONAL FINISHES:

- B Polished Brass
- C Rough Chrome Plated
- D Polished Chrome Plated



FIG. NO. DCF607OTS

- *175 LB WWP Iron Body Gate
- *Flanged
- *UL8/ULC listed
- *FM approved
- *Bolted bonnet
- *Outside screw and yoke
- *Solid wedge
- *Pre-grooved stem for tamper switch mounting.
- *175 psi non-shock cold water
- *Approved by the New York City board of Standards and Appeals

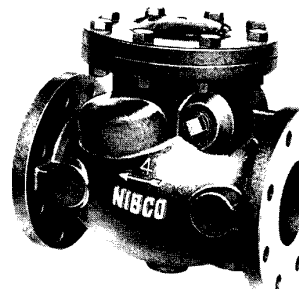

FIG. NO. DCF908W

- *175 LB WWP iron body check
- *Flanged
- *UL/ULC listed
- *FM approved
- *Bolted bonnet
- *Horizontal Swing
- *Renewable seat and disc
- *175 PSI non-shock cold water
- *Approved by the New York City board of Standards and Appeals

HOSE RACKS
HOSE ADAPTERS
FIRE DEPT INLET CONNECTIONS
PORTABLE FIRE EXTINGUISHERS
ALL AVAILABLE
CALL DUFF NOW!
610-275-4453

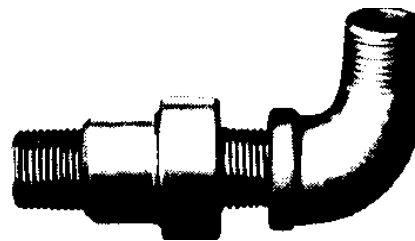

FIG. NO. DCBALLDRIP

- *1/2" Automatic Ball Drip
- *For installation on DCF908W
- *Closes against pressure
- *Opens when pressure is off, allowing water to drain from the fire department connection

HOSE GATE VALVES

WITH RISING STEM

FUNCTION: Used as a fire dept. outlet connection, designed for dry systems only. Unrestricted water way allows full flow. Suitable for use as a pump test valve.

REGULARLY FURNISHED: Cast brass valve with rising stem, red hand wheel. Female N.P.T. inlet x male hose thread outlet. Brass solid wedge disc and tapered set.

- OPTIONAL FINISHES:**
- B Polished Brass
 - C Rough Chrome Plated
 - D Polished Chrome Plated

SPECIFY thread

| Size | Pressure | Closed Open | | | | | | |
|---------|----------|-------------|--------|--------|--------|-------|-------|-------|
| | | A | B | C | C | D | E | F |
| 2 1/2 | 200 lb. | 5 3/4 | 12 1/2 | 15 | 17 1/2 | 2 1/2 | 4 1/2 | 5 3/4 |
| 3x2 1/2 | 300 lb. | 6 1/4 | 12 1/2 | 15 | 18 | 2 1/2 | 4 1/2 | 5 3/4 |
| 3 | 300 lb. | 7 1/2 | 14 1/2 | 17 1/2 | 21 | 3 | 5 1/2 | 7 |

ALL DIMENSIONS IN INCHES

| SIZE | FIG NO | PRICE |
|---------|--------|-------|
| 2 1/2 | 83703 | |
| 3X2-1/2 | 83704 | |
| 3 | — | |

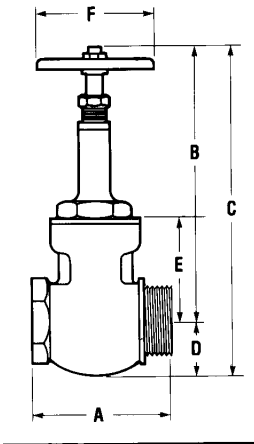

WITH NON-RISING STEM

FUNCTION: Used as a fire dept. outlet connection, designed for dry systems only. Unrestricted water way allows full flow. Suitable for use as a pump test valve. Non-rising stem feature requires less installation space.

REGULARLY FURNISHED: Cast brass valve with non-rising stem, red hand wheel. Female N.P.T. inlet x male hose thread outlet. Brass solid wedge disc and tapered seat.

- OPTIONAL FINISHES:**
- B Polished Brass
 - C Rough Chrome Plated
 - D Polished Chrome Plated

SPECIFY thread

| Size | Pressure | Closed Open | | | | | |
|---------|----------|-------------|-------|-------|-------|-------|-------|
| | | A | B | C | D | E | F |
| 1 1/2* | 200 lb. | 5 | 6 | 7 1/2 | 1 1/2 | 2 1/2 | 3 1/4 |
| 2 1/2 | 300 lb. | 5 1/4 | 7 3/4 | 9 3/4 | 2 | 3 1/2 | 5 1/4 |
| 3x2 1/2 | 300 lb. | 5 1/4 | 7 3/4 | 9 3/4 | 2 | 3 1/2 | 5 1/4 |

ALL DIMENSIONS IN INCHES

| SIZE | FIG NO | PRICE |
|---------|--------|-------|
| 1 1/2 | 83706 | |
| 2 1/2 | — | |
| 3X2 1/2 | 83708 | |

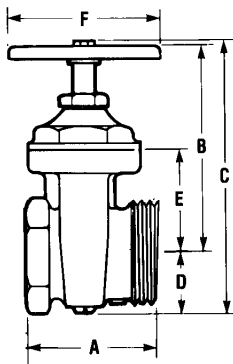

*NOT U/L LISTED

CAPS AND CHAINS

FUNCTION: Use to cover and protect male threads on valves and hydrants. Discourages entry of foreign matter.

REGULARLY FURNISHED: Cast brass cap with female hose thread, pin lugs and chain.

| SIZE | FIG NO | PRICE |
|--------|--------|-------|
| 3/4" | 83709 | |
| 1" | 83710 | |
| 1 1/2" | — | |
| 2 1/2" | 83711 | |
| 3" | 83712 | |
| 4" | 83713 | |

OPTIONAL FINISHES:

- B Polished Brass
- C Rough Chrome Plated
- D Polished Chrome Plated

VARIATIONS: with rocker lugs (suffix -RL)
2 1/2" and 3" size available in plastic (suffix -P)

SPECIFY: Thread.

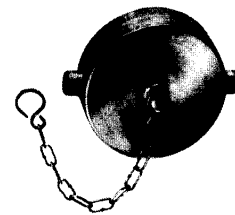

FIRE SPRINKLERS

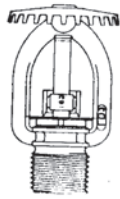

UPRIGHT
SPRINKLER
HEAD

| DESC | FIG. NO. | PRICE |
|---------|----------|-------|
| 165° BR | 10535 | |
| 165° CP | 10542 | |
| 212° BR | 37465 | |
| 286° BR | 37445 | |

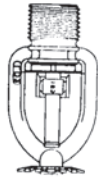

PENDANT
SPRINKLER
HEAD

| DESC | FIG. NO. | PRICE |
|---------|----------|-------|
| 165° BR | 10540 | |
| 165° CP | 10547 | |
| 212° BR | 36543 | |
| 212° CP | 36544 | |
| 286° BR | 37440 | |



SIDEWALL SPRINKLER

| DESC | FIG. NO. | PRICE |
|---------|----------|-------|
| 165° CP | 10560 | |

Call **DUFF**
for All Your Fire
Protection Needs!



RECESSED SPRINKLER
HEAD

| DESC | FIG. NO. | PRICE |
|-----------|----------|-------|
| W/ Trim | 17625 | |
| Less Trim | 55982 | |



FLAT ESCUTCHEON

| FIG. NO. | PRICE |
|----------|-------|
| 10566 | |



STANDARD
SPRINKLER
ESCUTCHEON

| FIG. NO. | PRICE |
|----------|-------|
| 10568 | |

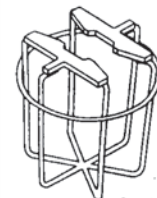

SPRINKLER
HEAD
GUARD

| DESC | FIG. NO. | PRICE |
|------------------|----------|-------|
| Red | 10570 | |
| Chrome Plated | 10572 | |

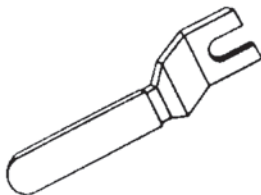

SPRINKLER HEAD
WRENCH

| FIG. NO. | PRICE |
|----------|-------|
| 10558 | |



1/4" PRESSURE GAUGE
VALVE

| FIG. NO. | PRICE |
|----------|-------|
| 62355 | |

SPRINKLER HEAD COLOR CODES

| | |
|------|--------|
| 135° | BLACK |
| 165° | BRONZE |
| 212° | WHITE |
| 280° | BLUE |
| 360° | RED |

CALL US FOR MORE INFORMATION!

OTHER FIRE ACCESSORIES



WATERFLOW
DETECTORS

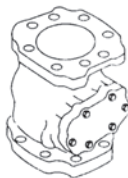

ALARM VALVE,
MODEL E, MODEL F

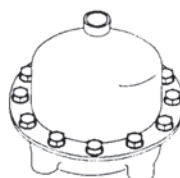

MODEL D RETARD
CHAMBER



WATER MOTOR ALARM



AIR & WATER
G A U G E .
Designed for
use on all
Grunau Fire
protection sys-
tems for conven-
ient pressure
readings .
Scaled in both PSI and bars.







CALL FOR PRICES AND AVAILABILITY

FIRE STOPS

SELECTION

Firestops are comprised of three essential inter-related components: the penetrated barrier, the penetrants, and the seal used to close the opening between the penetrants and the barrier. The firestopping seal is the last of the three components to be installed. Good planning can make firestopping simpler, more cost effective and safer.

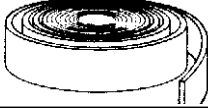
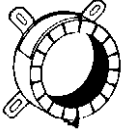
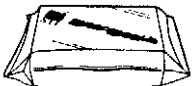
1. Select penetrants that have published firestop systems available.
2. Require a suitable annulus for installation of the appropriate firestop system.
3. Require sufficient spacing of penetrants from each other and other building elements.
4. Consider the environment of the installations and select an appropriate material and method.

| SELECTOR GUIDE | | | | |
|----------------|---|--|--|---|
| 1 | Large openings through concrete floors & walls | Cable trays Bus Duct Multiple Pipes Insulated Pipes Plastic Pipes | FIRE RATED MORTAR Series SSM |  |
| 2 | Medium to small openings in all constructions | Metallic Pipes Cable Trays Multiple Pipes Plastic Pipes Loose Cables Bus Duct Insulated Pipes | INTUMESCENT SEALANT Series SSS |  |
| 3 | Small to medium openings - all constructions | Metallic Pipes Metallic Pipes through sleeves Electrical or telephone cable | LATEX SEALANT Series LC150 |  |
| 4 | Small openings in all constructions (easy retrofit) | Metallic Pipes Loose cables | INTUMESCENT PUTTY Series SSP |  |
| 5 | Combustible penetrants field fabricated | Insulated pipes Plastic Pipes | OMTUMESCENT WRAP STRIPS All wrap strips |  |
| 6 | Combustible penetrants factory manufactured | Plastic pipes | INTUMESCENT COLLARS Series SSC |  |
| 7 | Medium to large openings (easy retrofit) | Cable tray Power, Voice, Data cables Fan Coils | FIRESTOP PILLOWS Series SSB |  |
| 8 | Large openings through concrete floors & walls | Cable trays Bus Duct Multiple pipes Insulated pipes Plastic pipes | SILICONE FOAM Series PEN200 |  |
| 9 | Construction joints, pipe with high temperature or movement | Metallic, steam pipes Safing & construction gaps Seismic joints | SILICONE SEALANT Series PEN300 |  |

SEE FOLLOWING PAGE FOR FIGURE NUMBERS AND PRICING

NOTE: Product shown is primary one to be used for application. Additional product(s) may be required.

FIRE STOPS

| REF | FIG. NO. | DESCRIPTION | SIZE / WGHT | PRICE |
|-----|----------|------------------------------------|----------------|-------|
| 1 | 73588 | SSM106 Firestop Mortar | 6 Gal | |
| | 73589 | SSM22B Firestop Mortar | 22 lb. | |
| 2 | 73571 | SSS100 Red Latex Sealant | 10.5 oz. | |
| | 73573 | SSS102 Red Latex Sealant | 2 Gal. | |
| | 73574 | SSS105 Red Latex Sealant | 5 Gal. | |
| 3 | 73575 | LC150 Green Latex Sealant | 10.5 oz. | |
| | 73576 | LC152 Green Latex Sealant | 2 Gal. | |
| | 73577 | LC155 Green Latex Sealant | 5 Gal. | |
| 4 | 73581 | SSP100 Instrumescent Putty Tube | | |
| 5 | 74932 | SSWRED Intumescent Red Wrap | | |
| 6 | 73582 | SSC151 1 1/2" Instrumescent Collar | | |
| | 73584 | SSC202 2" Instrumescent Collar | | |
| | 73585 | SSC301 3" Instrumescent Collar | | |
| | 73586 | SSC400 4" Instrumescent Collar | | |
| | 73587 | SSC600 6" Instrumescent Collar | | |
| 7 | 73590 | SSB14 Firestop Pillow | 1x4x9 | |
| | 73591 | SSB24 Firestop Pillow | 2x4x9 | |
| | 73592 | SSB26 Firestop Pillow | 2x6x9 | |
| | 75850 | SSB36 Firestop Pillow | 3x6x9 | |
| 8 | 83964 | PEN200 Silicone Foam | 100 lb. | |
| 9 | 73578 | PEN300 Silicone Sealant | 10.3 oz. | |
| | 73579 | PEN302 Silicone Sealant | 2 Gal. | |
| | 73580 | PEN305 Silicone Sealant | 5 Gal. | |

COUPLINGS FOR GROOVED-END PIPE

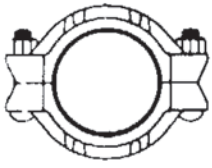

Standard coupling

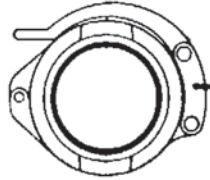

Hingelok Coupling

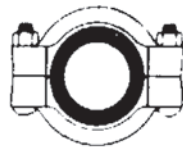

Reducing Coupling

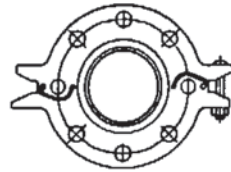

Gruvlok 300# flange

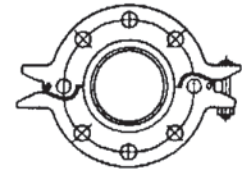

2" — 12"

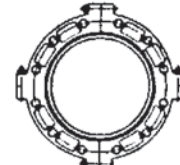

14" — 24"

GROOVED END FITTINGS



90 Deg. Bend



45 Deg. Bend



22 1/2 Deg. Bend



11 1/4 Deg. Bend

Gruvlok Flange

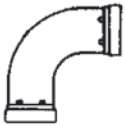

Long radius
90 deg. elbow



Long radius
45 deg. elbow



Groove X M
90 deg. elbow



Groove X M
45 deg. elbow

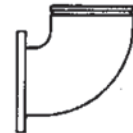

Reducing base support
elbow

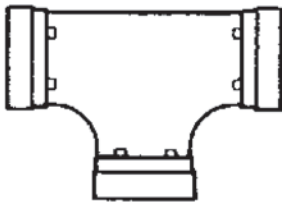

Groove Tee

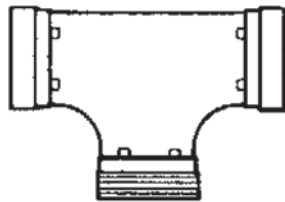

Groove tee with threaded
branch

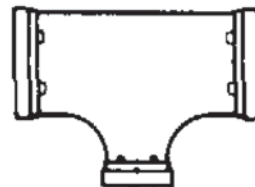

Reducing Tee

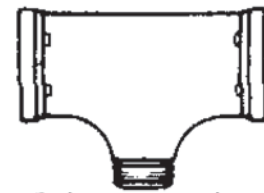

Reducing tee with
threaded branch



Concentric reducer



Reducer, threaded,
small end



Eccentric reducer



Steel swaged nipple

GROOVED END FITTINGS

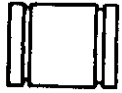

Adapter Nipple
GrxGr

| FIG. NO. | PRICE |
|----------|-------|
| D7080 | |

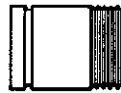

Adapter Nipple
GrxMPT

| FIG. NO. | PRICE |
|----------|-------|
| D7081 | |



Adapter Nipple
GrxBEV

| FIG. NO. | PRICE |
|----------|-------|
| D7082 | |

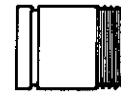

Di-Electric Nipple
(GrxMPT)

| FIG. NO. | PRICE |
|----------|-------|
| D7088 | |



Di-Electric Nipple
(GRXGR)

| FIG. NO. | PRICE |
|----------|-------|
| D7089 | |



Hose Nipple

| FIG. NO. | PRICE |
|----------|-------|
| D7086 | |



Bullhead Tee

| FIG. NO. | PRICE |
|----------|-------|
| D7062 | |



Bull Plug

| FIG. NO. | PRICE |
|----------|-------|
| D7075 | |

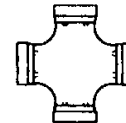

Cross

| FIG. NO. | PRICE |
|----------|-------|
| D7068 | |



Cap

| FIG. NO. | PRICE |
|----------|-------|
| D7074 | |

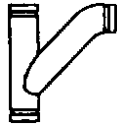

Tee Wye

| FIG. NO. | PRICE |
|----------|-------|
| D7066 | |

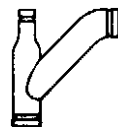

Reducing Tee

| FIG. NO. | PRICE |
|----------|-------|
| D7067 | |

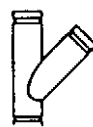

Lateral

| FIG. NO. | PRICE |
|----------|-------|
| D7069 | |

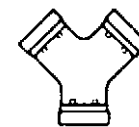

True Wye

| FIG. NO. | PRICE |
|----------|-------|
| D7071 | |

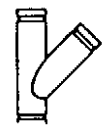

Reducing Lateral

| FIG. NO. | PRICE |
|----------|-------|
| D7070 | |



Standpipe Tee

| FIG. NO. | PRICE |
|----------|-------|
| D7065 | |

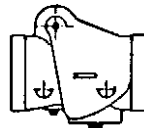

Grooved end check
valve

| FIG. NO. | PRICE |
|----------|-------|
| D7800 | |

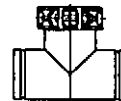

Grooved end strainer

| FIG. NO. | PRICE |
|----------|-------|
| D7260 | |

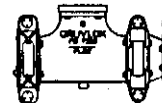

Gruvlok suction
diffuser

| FIG. NO. | PRICE |
|----------|-------|
| D7250 | |

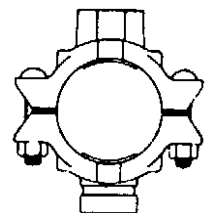

Clamp-T Cross

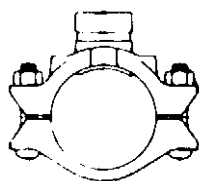

Grooved outlet mid
pipe outlet

| FIG. NO. | PRICE |
|----------|-------|
| D7046 | |

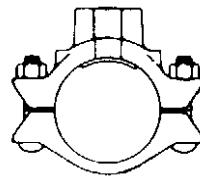

FPT outlet mid pipe
outlet

| FIG. NO. | PRICE |
|----------|-------|
| D7045 | |

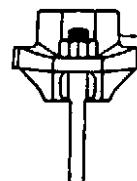

Clamp-T with U-bolt

| FIG. NO. | PRICE |
|----------|-------|
| D7044 | |

Thread X Thread

| FIG. NO. | PRICE |
|----------|-------|
| D7047 | |

Groove X Groove

| FIG. NO. | PRICE |
|----------|-------|
| D7048 | |

Groove X Thread

| FIG. NO. | PRICE |
|----------|-------|
| D7049 | |

FIRE HOSE, FITTINGS AND ACCESSORIES

300# SINGLE JACKET ALL POLYESTER FIRE HOSE

300 PSI PROOF PRESSURE
 150 PSI SERVICE TEST PRESSURE
 135 PSI WORKING PRESSURE



UNCOUPLED - per foot



COUPLED - per 50' length

| SIZE | FIG. NO. | PRICE |
|--------|----------|-------|
| 1 1/2" | | |
| 2" | 11348 | |
| 3" | 11352 | |
| 4" | | |

| SIZE | FIG. NO. | PRICE |
|--------|----------|-------|
| 1 1/2" | 11354 | |
| 2" | | |
| 3" | | |
| 4" | | |

FIRE HOSE NOZZLE

Brass
 Female with washers



| SIZE | FIG. NO. | PRICE |
|----------|----------|-------|
| 3/4X6 | 4781 | |
| 1X8 | 4793 | |
| 1 1/2X10 | 55282 | |

FOG NOZZLE

With rubber bumpers



| SIZE | FIG. NO. | PRICE |
|-----------|----------|-------|
| 1 1/2 IPT | 63888 | |
| 1 1/2 NST | 63889 | |

BUCKLEY STYLE FIRE HYDRANT ADAPTER/REDUCER

Cast brass with washer
 Pin lug

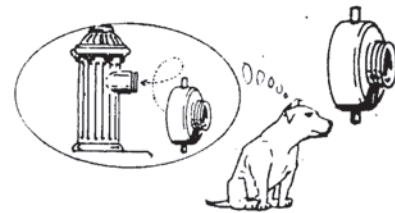

HYDRANT WRENCH

5 hole
 Cast Iron



| FIG. NO. | PRICE |
|----------|-------|
| 47909 | |

SPANNER WRENCH

For pin lug couplings
 Cast Iron



| SIZE | FIG. NO. | PRICE |
|-------|----------|-------|
| 1 1/2 | 4589 | |
| 2 | 4593 | |
| 3 | 4596 | |
| 4 | 4598 | |

| SIZE | FIG NO |
|--------------------------|--------|
| 2-1/2" FNST X 3/4" GH | 63893 |
| 2-1/2" FNST X 1-1/2" IPT | 63894 |
| 2-1/2" FNST X 1-1/2" NST | 63895 |
| 2-1/2" FNST X 2" IPT | 63896 |

**NOTE: MUST SPECIFY
 HYDRANT THREAD SIZE WHEN
 ORDERING SIZES
 FROM 1 1/2 TO 4"
 NST AVAILABLE FOR HYDRANT
 ADAPTER**

**DUFF
 DELIVERS**



How to Order

Submit your order online

or

email info@duffco.com

Be sure to include

product numbers

descriptions

quantities

Don't forget to include your name!

Contact name _____ Contact Date _____

| | | |
|---|---|---|
|  | <h2 style="margin: 0;">DUFF COMPANY</h2> <p style="margin: 0;">201 East Lafayette Street Norristown, PA 19401</p> <p style="margin: 0;">Phone: 610-275-4453 Fax: 610-279-6761</p> |  |
|---|---|---|

Legal Name _____

Name in which business is conducted _____

Billing Address _____

City _____ State _____ Zip _____

Purchasing Phone _____ A/P Phone _____ Fax _____



Principal's Name _____

Principal's Address _____

City _____ State _____ Zip _____

Phone (Office) _____ (Cell) _____ E-mail address _____

Website address (If applicable) _____

Primary Contact _____ Title _____



SHIPPING ADDRESS - IF DIFFERENT

Shipping Address _____ Phone _____

City _____ State _____ Zip _____

Tax Exempt Number _____ Provide a copy of Certificate. We CAN NOT set up a Tax Exempt Account without certification.



TYPE OF BUSINESS

Plumbing _____ Pumps _____ Heating _____ Municipality _____ Hotel or Apts. _____ Well Drilling _____
 Hospital _____ Factory (OEM) _____ Factory (Mtn) _____ Office Building _____ Shopping Center _____
 Golf Course _____ Water Treatment _____ Environmental _____ Other (Please name) _____

Have you been contacted by one of our salesman? _____ Name _____

If YES, please explain _____

Name of person authorized to pick up _____

D&B Rating _____ Check one: Corporation _____ Partnership _____ Individual Proprietor _____

If division of another company, name parent company and relationship _____

DUFF COMPANY

201 East Lafayette Street, Norristown, PA 19401

TRADE REFERENCES

Name _____ Type of business _____

Address _____

City _____ State _____ Zip _____

Phone _____ Fax _____



Name _____ Type of business _____

Address _____

City _____ State _____ Zip _____

Phone _____ Fax _____



Name _____ Type of business _____

Address _____

City _____ State _____ Zip _____

Phone _____ Fax _____



Bank reference _____

Branch Address _____

City _____ State _____ Zip _____

Branch officer who handles account _____

In consideration of your opening the above account and/or extended credit, the undersigned hereby agrees that all information supplied in this application is correct, that all accounts are to be paid in full to Duff Company monthly by the tenth day of the month following the invoice date, that a 1% service charge and a 1% interest charge will be made on any balance open at the end of the month following invoice date, and that in the event that legal action or lien be taken, or the service of a collection agency are used to collect this account, the undersigned shall pay all expenses incurred by the Duff company, such as, but not limited to, collection fees, costs and legal fees.

Applicant (Name of Account) _____

By _____ Title _____

The undersigned _____ and _____
for good and valuable consideration, hereby jointly, severally and personally unconditionally guarantee, warrant and promise the full and prompt (within terms) payments of all bills and other obligations (as set forth above) of the applicate in connection with any credit extended to the applicant by Duff Company.*

Principal _____ Witness _____ Principal's Spouse _____ Witness _____

Principal _____ Witness _____ Principal's Spouse _____ Witness _____

We routinely fax invoices to our customers. Please provide a fax number where we can send invoices _____

PLEASE FAX FORM TO 610-275-6761

*As appropriate, we may also require the guarantee of a principal and, in some cases, the principal's spouse.

| For Duff Company Use Only | | | |
|---------------------------|------------------------|-------------------------|--|
| Credit Limit: _____ | Contact: _____ | Certificate Recd: _____ | |
| Tax Jurisdiction: _____ | General Manager: _____ | Type: _____ | |
| Salesman: _____ | Class: _____ | Controller: _____ | |
| | Date Approved: _____ | | |